

13 415 979 Product version from 10/1/2023

















- CASCADE, max. flow rate 26.5 l/min (at 3 bar)
- Function from: 22.5 l/min
- with anti-scale system

Technical data:

- cover plate 240 x 60 mm
- 150mm projection
- 1/2" connection
- plug-link mounting

Notes:

	Matte Black	13 415 979-33
	Chrome	13 415 979-00
	Brushed Platinum	13 415 979-06
	Platinum	13 415 979-08
	Dark Chrome	13 415 979-19
	Light Gold (PVD)	13 415 979-26
	Brushed Light Gold (PVD)	13 415 979-27
	Brushed Durabronze (23kt Gold)	13 415 979-28
	Brushed Gold (PVD)	13 415 979-37
	Brushed Dark Brass (PVD)	13 415 979-39
	Brushed Bronze (PVD)	13 415 979-42
	Brushed Dark Bronze (PVD)	13 415 979-43
	Brushed Champagne (22kt Gold)	13 415 979-46
	Champagne (22kt Gold)	13 415 979-47
	Brushed Chrome	13 415 979-93
	Brushed Dark Platinum	13 415 979-99

Recommended miscellaneous



- Concealed wall elbow -**
- min. recess depth 90 mm
 - max. recess depth 163 mm

35 085 970 90

Recommended miscellaneous



- Concealed wall elbow -**
- min. recess depth 90 mm
 - max. recess depth 163 mm

35 085 970 90

13 415 979 Product version from 10/1/2023

mm [inches]

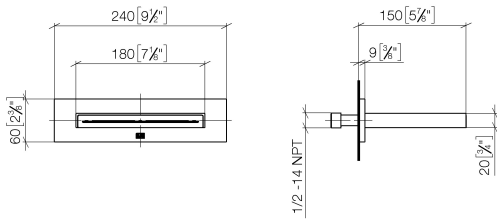

Flow rate chart

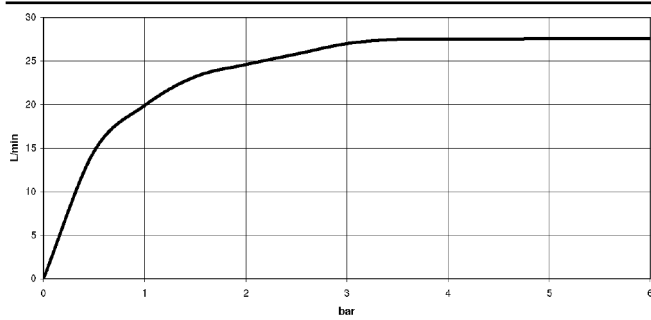

Trajectory diagram

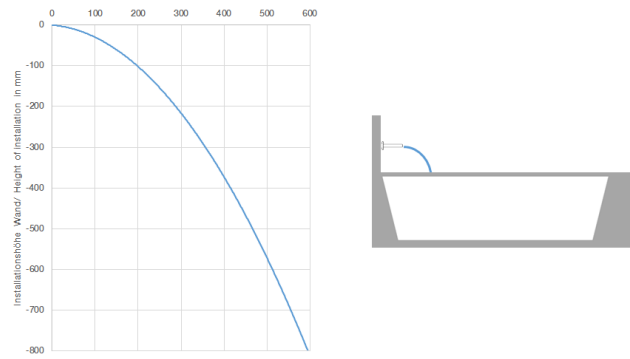

Codes & Standards

ASME A112.18.1	cUPC	DIN 4109	ISO 3822
Scottish Water Byelaws	UK Water Supply Regulations	Ü-Zeichen	



WATER SHEET Cascade spout for wall mounting - Matte Black

SERIES-VARIOUS

13 415 979 Product version from 10/1/2023

Certificates and sustainability

WRAS_2306

LGA_19

IAPMO_4976

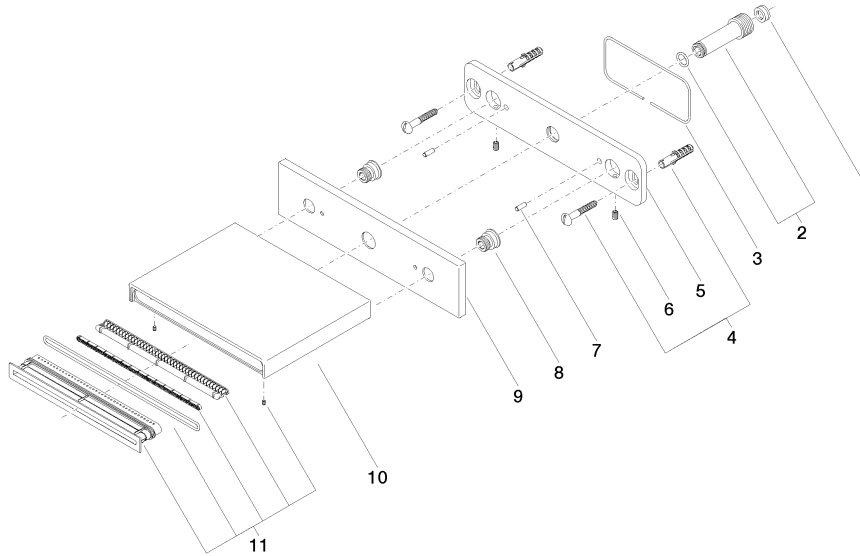

Spare parts list

No.	Item Number	Name	Quantity used	Delivery time
9	09 27 78 031-33	Rosette 240 x 60 x 9 mm - Matte Black	1.00	40
3	09 14 03 134 90	Washer Round cord Ø 2 x 295 mm -	1.00	14
5	09 17 97 059 90	Holder 234 x 55 x 7 mm -	1.00	14
6	09 31 11 036 90	Mounting Threaded pin with hexagon socket with cup point M5 x 8 mm -	2.00	14
2	90 24 03 213 00 90	Nipple Ø 21 x 70 mm -	1.00	14
4	04 30 31 024 01 90	Attachment set Wood screw with dowel 6 x 40 mm -	1.00	14
1	09 23 01 057 90	Flow limiter red 26,5 l/min. -	1.00	14
7	09 31 11 040 90	Straight pin Ø 6 x12 mm -	2.00	14
10	09 11 78 003 20-33	Spout 180 x 20 x 141 mm - Matte Black	1.00	40
11	90 29 03 059 00 90	Beam shaper 175 x 20 x 35 mm -	1.00	14
8	09 24 03 214 90	Nipple Ø 19 x 16 mm -	2.00	14