

EU
xComfort CHVZ-01/04

CHVZ-01/04

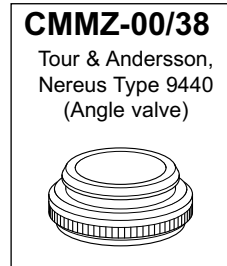
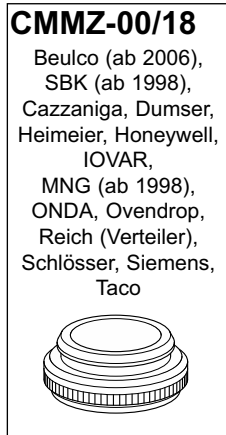
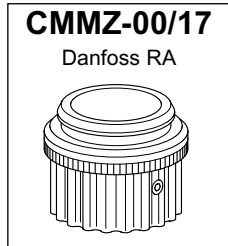
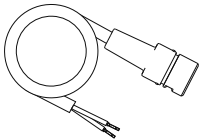
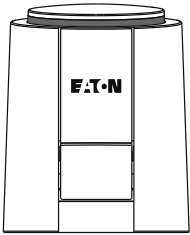

230VAC/1W/50Hz

	T=-25°C - +60°C
	T=0°C - +100°C

IP54

100N ± 5%

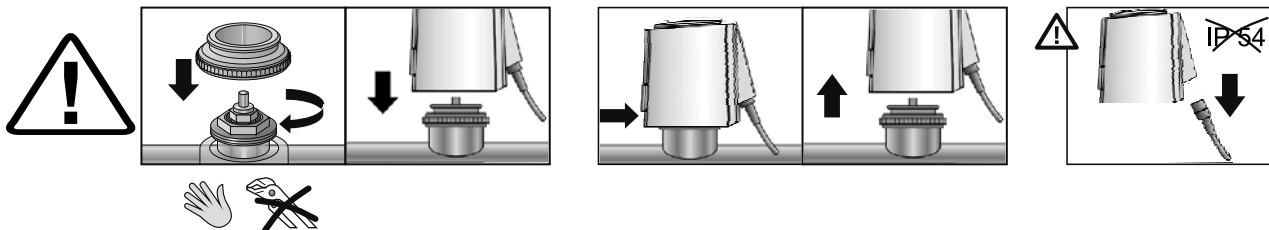
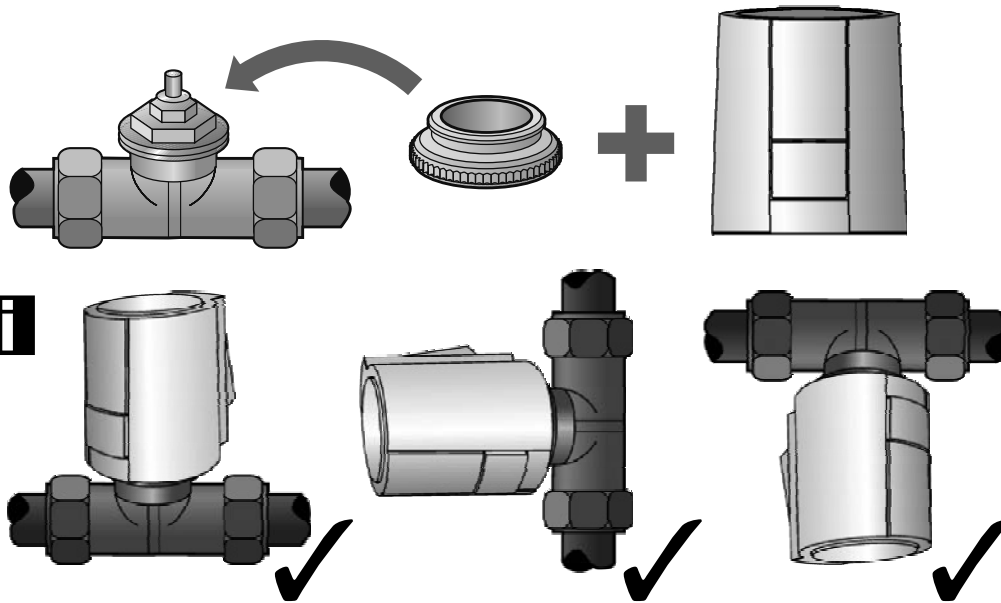

1.x

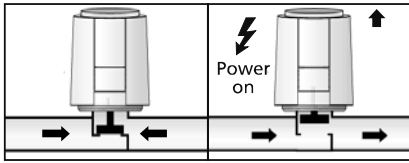
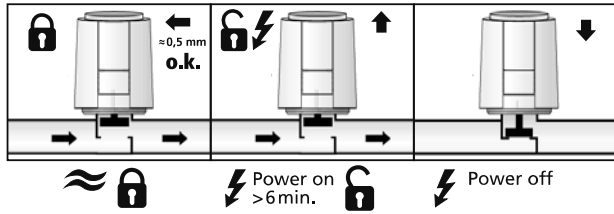
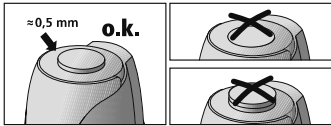

	0,75 mm ²
	10 mm

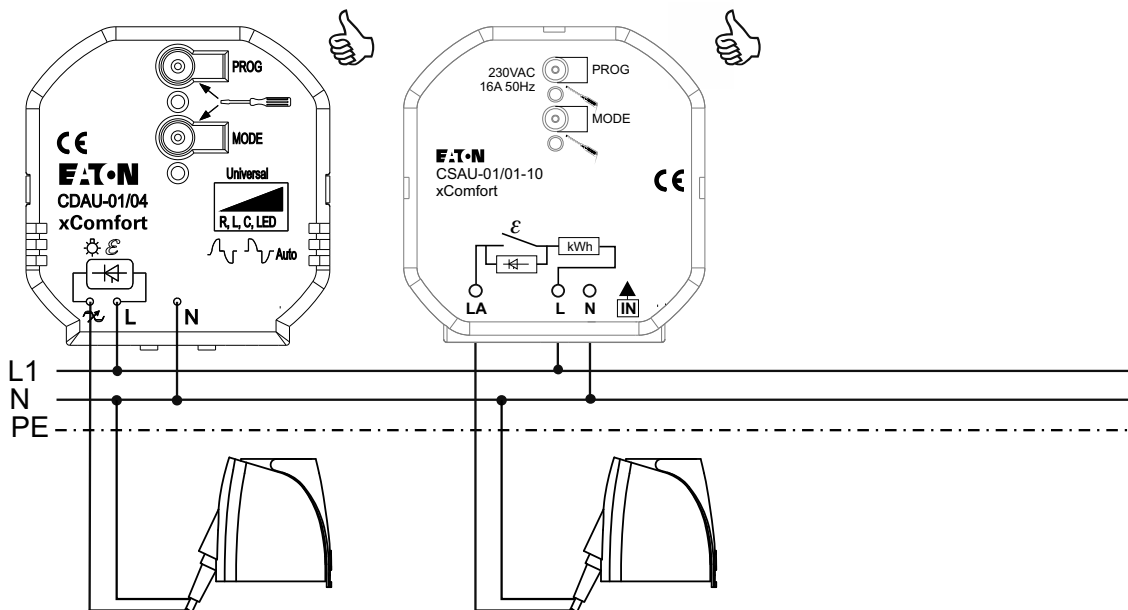
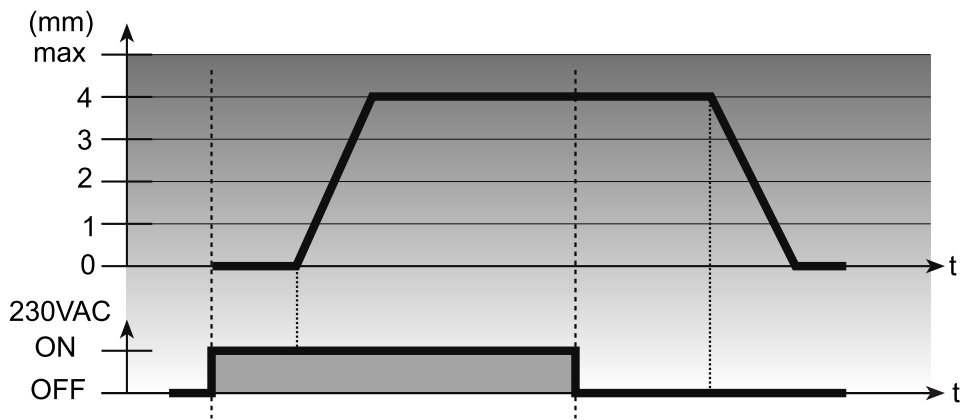
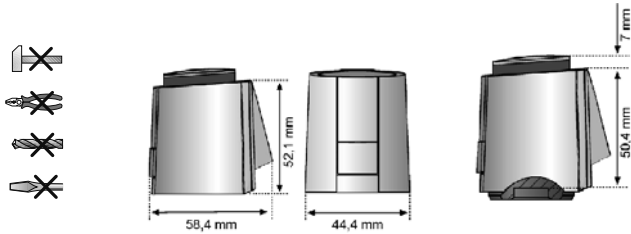



Declaration of Conformity

We, EATON Industries (Austria) GmbH
3943 Schrems, Eugenia 1
Austria

declare under our sole responsibility that the product (family)

Eaton - Valve-Drive NC

CHVZ-01/04

(the declaration of conformity applies to all listed types within our actual product catalogue)

provided that it is installed, maintained and used in the application intended for, with respect to the relevant manufacturer's instructions, installation standards and "good engineering practices"

complies with the provisions of Council directive(s):

Low Voltage Directive 2014/35/EU

EMC Directive 2014/30/EU

RoHS Directive 2011/65/EU

based on compliance with following standard(s):

EN 60730-2-14:1997 + A1:2001 + A2:2008 + A11:2005 + A2:2008,
EN 60730-1:2016, EN 50419:2006, EN 50581:2012



17.11.2017

Fernando Ceccarelli
Senior Vice President
General Manager

Friedrich Schröder
Director Quality
& Systems

Affixing date of CE mark: 2015

Doc.Id.: CHVZ-0104_171117

<h2>RF- SYSTEM</h2> <h3>BASIC - MODE - CARD</h3>	
<p>CTAA-01/01 CTAA-02/01</p> <p>CBEU-02/01 CBEU-02/02</p> <p>M1 M2 M3 M4 1x 2x 3x 4x</p> <p>CRCA-00/01</p> <p>CHSZ-00/01</p>	<p>CSAU-01/01</p> <p>CJAU-01/01</p> <p>CDAU-01/01</p>

