











33 800 888



- Ausladung 201 mm
- schwenkbarer Auslauf 360°
- luftangereicherter Strahl
- Armaturenhöhe 325 mm
- Höhe bis Luftsprudler 180 mm
- Bohrungsdurchmesser 35 mm
- Durchfluss max. 7 l/min bei 3 bar Fließdruck
- bleifrei
- Dieses Produkt leistet einen Beitrag zur Erfüllung der Vorgaben von nachhaltigen Gebäudezertifizierungen, z.B. LEED®, BREEAM®, DGNB

	Dark Brass gebürstet (PVD)	33 800 888-39
	Chrom	33 800 888-00
	Platin gebürstet	33 800 888-06
	Platin	33 800 888-08
	Messing (23kt Gold)	33 800 888-09
	Dark Chrome	33 800 888-19
	Messing gebürstet (23kt Gold)	33 800 888-28
	Schwarz matt	33 800 888-33
	Bronze gebürstet (PVD)	33 800 888-42
	Champagne gebürstet (22kt Gold)	33 800 888-46
	Champagne (22kt Gold)	33 800 888-47
	Chrom gebürstet (Edelstahl-Look)	33 800 888-93
	Dark Platin gebürstet	33 800 888-99

Empfohlenes Zubehör

**Spender mit Rosette - Dark Brass gebürstet (PVD)** 82 444 970-39



Empfohlenes Zubehör

**Exzenterbetätigung mit Drehknopf - Dark Brass gebürstet (PVD)** 10 710 970-39



33 800 888

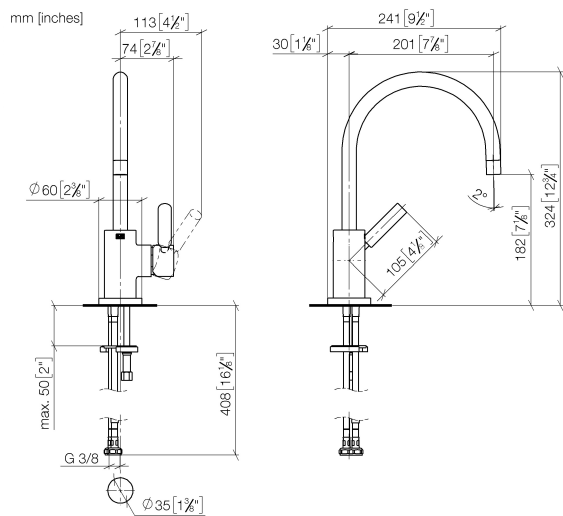

Durchflussdiagramm

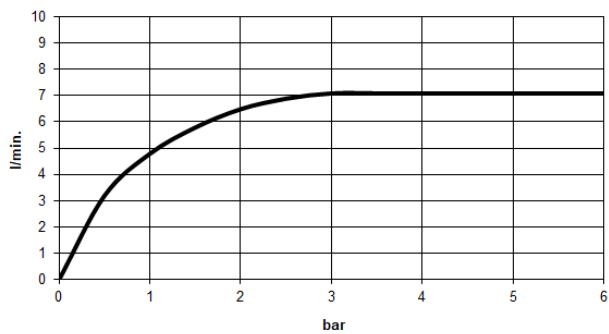

Codes & Standards

DIN 4109	EN 817	Executive Order no. 1007	ISO 3822
Scottish Water Byelaws	UK Water Supply Regulations	Ü-Zeichen	VA-Zeichen



## TARA Einhebelmischer - Dark Brass gebürstet (PVD)

TARA

33 800 888

### Zertifikate und Nachhaltigkeit

WRAS\_2311

GDV\_0400

ETA\_18

LGA\_8

EPD-DOR-20230287  
-IBA-DE Umwelt-  
Produktdeklaration

33 800 888

Ersatzteile für die  
anderen  
Oberflächenvarianten  
finden Sie hier:  
Chrom

