

Productinformatieblad

Specificaties

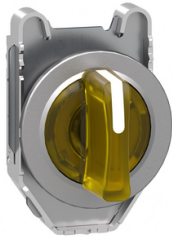

flush mounted xb4 yellow selector switch 3-position

ZB4FK1383

Belangrijk bericht: A change in appearance may be noted on the product but does not affect its use in terms of function and safety. This makes it compatible with our Universal LED blocks
EAN Code: 3606489582135

Prijs: 28,30 EUR

Hoofd

range of product	Harmony XB4
product of component type	Kop voor verlichte keuzeschakelaar
compatibiliteit product	Universele LED
device short name	ZB4F
kraag materiaal	Verchroomd metaal
koptype	Built-in-flush
bevestigingsdiameter	30,5 mm
verkoop per ondeelbare hoeveelheid	1
vorm van kop signaleringseenheid	Rond
type operator	blijven
profiel operator	Geel standaard hendel
informatie positie operator	3 standen +/- 45°

Complementair

CAD totale breedte	36,6 mm
CAD totale hoogte	36,6 mm
CAD totale diepte	47 mm
gewicht product	0,078 kg
weerstand hoge druk drukring	7000000 Pa om 55 °C, afstand: 0.1 m
mechanical durability	500000 cycles
elektrische samenstellingscode	M3 voor <4 contacten gebruik enkelvoudig blokken in vooraan gemonteerd met integrale LED M6 voor <2 contacten gebruik enkelvoudig blokken in vooraan gemonteerd met ingebouwde LED en transformator M10 voor <2 contacten gebruik enkelvoudig blokken in vooraan gemonteerd met integrale LED M4 voor <4 contacten gebruik enkelvoudig en dubbel blokken in vooraan gemonteerd met integrale LED
product presentatie	Basisonderdeel

Omgeving

beschermende behandeling	TH
ambient air temperature for storage	-40...70 °C

De weergegeven prijs is de adviesprijs in euro excl. BTW. Deze kan onderhevig zijn aan korting. Neem contact op met uw lokale distributeur of detailhandel voor de daadwerkelijke prijs

omgevingstemperatuur voor werking	-40...70 °C
overvoltage category	Klasse I In overeenstemming met IEC 60536
IP beschermingsgraad	IP66 In overeenstemming met IEC 60529 IP67 In overeenstemming met IEC 60529 IP69 In overeenstemming met IEC 60529 IP69K In overeenstemming met ISO 20653 Type 13 In overeenstemming met UL 50 E Type 12 In overeenstemming met UL 50 E Type 4 In overeenstemming met UL 50 E Type 4X In overeenstemming met UL 50 E
IK-beschermingsgraad	IK04 In overeenstemming met IEC 50102
standards	CSA C22.2 Nr 14 IEC 60947-5-1 IEC 60947-5-4 UL 508 IEC 60947-1 JIS C8201-5-1 CE JIS C8201-1
product certifications	UL listed CSA CCC EAC
trilling bestendigheid	5 gn (f= 10...500 Hz) In overeenstemming met IEC 60068-2-6 2 mm piek-piek (f= 2...10 Hz) In overeenstemming met IEC 60068-2-6
schokbestendigheid	30 gn (duur = 18 ms) voor halve sinusgolf versnelling In overeenstemming met IEC 60068-2-27 50 gn (duur = 11 ms) voor halve sinusgolf versnelling In overeenstemming met IEC 60068-2-27 25 gn (duur = 6 ms) voor 1000 schokken op elke as In overeenstemming met IEC 60068-2-27

Verpakkingseenheid

Eenheidstype van verpakking 1	PCE
Aantal eenheden in verpakking 1	1
verpakking 1 hoogte	4,3 cm
verpakking 1 breedte	5,2 cm
verpakking 1 lengte	5,5 cm
verpakking_1_gewicht	78,0 g

contractuele waarborg

Garantie (in maanden)	18
------------------------------	----

Schneider Electric wil tegen 2050 de Net Zero-status hebben bereikt via partnerschappen in de toeleveringsketen, materialen met een lagere impact en circulariteit via onze doorlopende campagne "Use Better, Use Longer, Use Again" om de levensduur van producten en de recycleerbaarheid te verlengen.

[Uitleg van Environmental Data >](#)

[Hoe evalueren we de duurzaamheid van producten? >](#)

Milieuoetafdruk

Totale levenscyclus ecologische voetafdruk	0.7 kg CO2 eq.
Koolstofvoetafdruk van de fabricagefase [A1–A3]	0.6 kg CO2 eq.
Koolstofvoetafdruk van de distributiefase [A4]	0 kg CO2 eq.
Koolstofvoetafdruk van de installatiefase [A5]	0 kg CO2 eq.
Koolstofvoetafdruk van de gebruiksfase [B2, B3, B4, B6]	0 kg CO2 eq.
Koolstofvoetafdruk van de einde-levensfase [C1–C4]	0.1 kg CO2 eq.
Milieu Profiel	Milieuprofiel van het product

Use Better

Materialen en verpakking

Pakket met gerecycleerd karton	Ja
Verpakkingen zonder kunststof	Ja
RoHS-richtlijn van de EU	Conform
REACH-verordening	Referentie bevat geen SVHC boven drempelwaarde

Use Longer

Levensduurverlenging

Reparatie	Nee
-----------	-----

Use Again

Herverpakken en herfabriceren

Circulair Profiel	Informatie over einde levensduur
Terugname	Ja

Dimensions Drawings

Dimensions

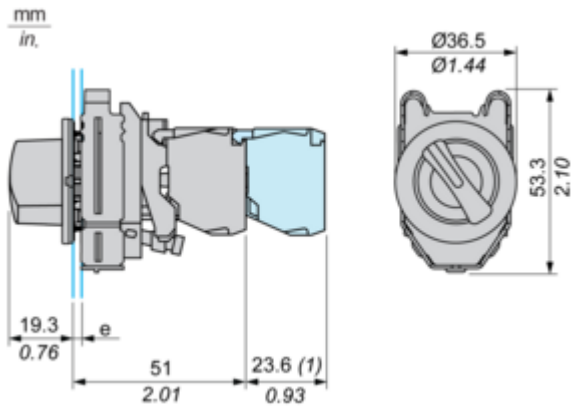

e : clamping thickness: 1 to 6 mm / 0.04 to 0.24 in.

(1) : Additional row of contacts

Mounting and Clearance

Panel Cut-out for Pushbuttons, Switches and Pilot Lights (Finished Holes, Ready for Installation)

Connection by Screw Clamp Terminals or Plug-in Connectors



(1) : Diameter on finished panel or support

(2) : $\text{Ø}30.75 \text{ mm recommended } (\text{Ø}30.5 \text{ }_0^{+0.5}) / \text{Ø}1.21 \text{ in. recommended } (\text{Ø}1.20 \text{ in. }_0^{+0.0196})$

Connections	a in mm	a in in.	b in mm	b in in.
By connectors	50	1.97	40	1.57
By connectors and with legend holder ZBZF32	50	1.97	40	1.57
By connectors and with legend holder ZBZF33	60	2.36	40	1.57

Technical Description

Electrical Composition Corresponding to Code M3

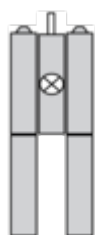

Electrical Composition Corresponding to Code M4



Electrical Composition Corresponding to Codes M6 and P2



Electrical Composition Corresponding to Codes M5, M10, MF1, MR1 and MF2



Legend

Single contact



Double contact



Light block



Possible location



Sequence of Contacts Fitted to 3-position Selector Switch Body

Position 315°



Push	Position	Top			
		Bottom			
	Location		Left		Right
	State		1		0
Contacts	N/O		closed	open	
	N/C		open	closed	





Position 0°



Push	Position	Top			
		Bottom			
	Location		Left		Right
	State		0		0
Contacts	N/O		open	open	
	N/C		closed	closed	

Position 45°



Push	Position	Top			
		Bottom			
	Location		Left		Right
	State		0		1
	Contacts	N/O			open
N/C		closed	open		

Technical Illustration

Dimensions

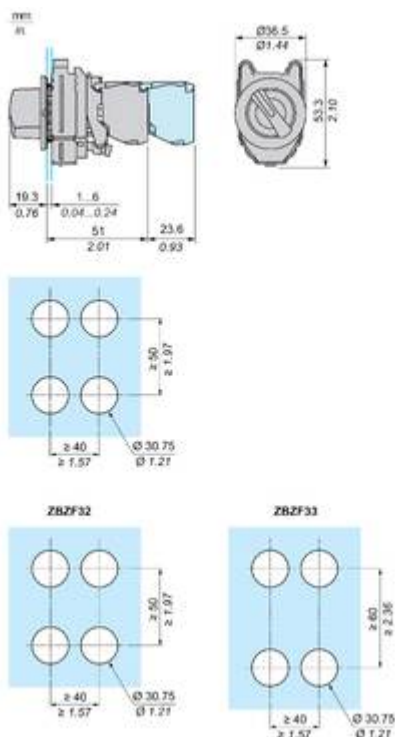

Image of product / Alternate images

Alternative

