

Plug

Part number: 636A



MENNEKES
Elektrotechnik GmbH & Co. KG

Aloys-Mennekes-Straße 1
57399 Kirchhundem
GERMANY

www.MENNEKES.org

Product Description

- screw connection technology
- protection against kinking
- strain relief

Technical Details

Plug	636A
Ampere	16A
Number of poles	3p
Nominal voltage AC	20 - 25V
Nominal frequency	50 - 60 Hz
Protection type IP	IP44
Contact carrier	standard
Connection	screw terminals
Contact screw drive	PZ2, slot
Recommended wire end treatment for supply cable connection terminal	ferrule square gasproof crimped
Phase inverter	without phase inverter
Pilot contact	without pilot contact
Conductor cross-section min.	4 mm ²
Conductor cross-section max.	10 mm ²
Cable kink protection	with cable kink protection
Protective grommet	without protective grommet
Protective cap	without protective cap
Weight (net)	153 g
Packaging unit	10 pcs
EAN / identification number	4015394004806

Permissible ambient conditions

	Min.	Max.
Permanent ambient temperature	-25 °C	40 °C

Material properties

Front part	PA6 purple [similar RAL 4001]
Housing	PC/PET light grey [similar RAL 7035]

Material resistance

The material resistance overview can be found on the website in the section “Knowledge” - “Product knowledge” - “Materials”.

Material and environmental properties

RoHS 2011/65/EU incl. 2015/863/EU	✓
POP regulation (EU) 2019/1021	✓

Regulations and Standards

Norm	DIN EN IEC 60309-2
Declaration of Conformity	CE
Test label	EAC

Dimensional Drawing

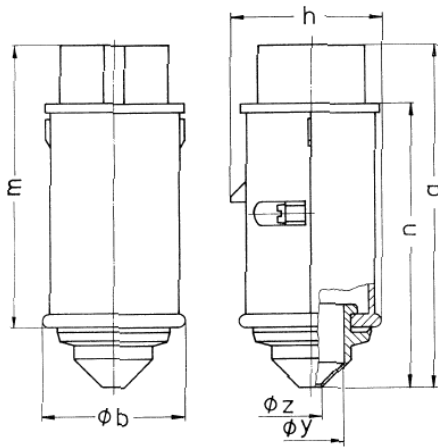

Drawing	Amp. Poles	16		32	
		2	3	2	3
2 MB 159					
Dim. in mm	a	130	130	130	130
	b	55	55	55	55
	h	58	58	58	58
	m	108	108	108	108
	n	107	107	107	107
	y	25	25	25	25
	z	9	9	9	9
Terminal for cond. cross		4	4	4	4
section (mm ²) min.-max.		—10	—10	—10	—10