

Plug PowerTOP Xtra R

Part number: 13204

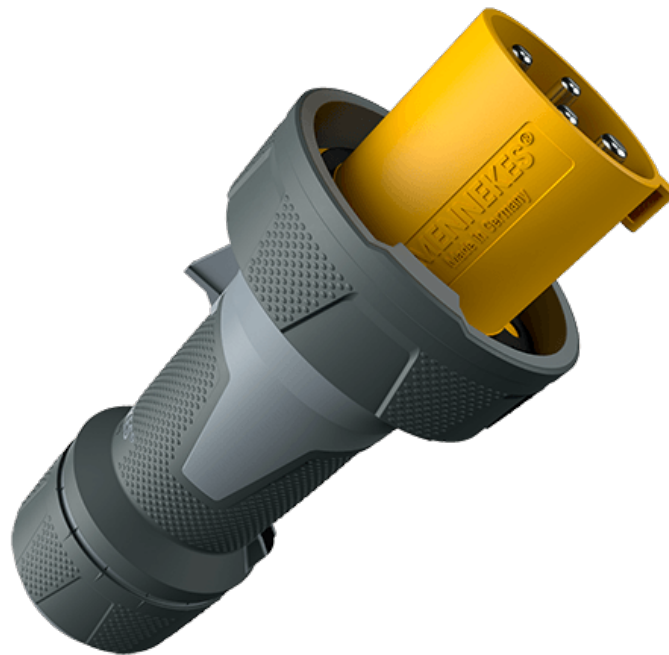

MENNEKES
Elektrotechnik GmbH & Co. KG

Aloys-Mennekes-Straße 1
57399 Kirchhundem
GERMANY

www.MENNEKES.org

Product Description

- economic enclosure design with nubbed grip areas
- enclosure with thread lock and safety slide
- rubberised bayonet ring
- highly heat resistant contact carrier, nickel plated contacts
- frame terminals
- protection against kinking
- strain relief
- rubberised cable gland with sealing

Technical Details

Plug PowerTOP Xtra R	13204
Product serie	PowerTOP Xtra R
Ampere	63A
Number of poles	4p
Clock position	4h
Nominal voltage AC	110V
Nominal frequency	50 - 60 Hz
Protection type IP	IP67
Contact carrier	highly heat resistant contact carrier, nickel plated contacts
Connection	frame terminals
Contact screw drive	PZ2, slot
Tightening torque connection terminal	2 Nm
Recommended wire end treatment for supply cable connection terminal	usable with and without ferrule
Strip length jacket	80 mm
Strip length conductor	18 mm
Phase inverter	without phase inverter
Pilot contact	1 pilot contact
Conductor cross-section min.	6 mm ²
Conductor cross-section max.	16 mm ²
Cable kink protection	integrated in cable gland
Protective grommet	without protective grommet
Protective cap	without protective cap
Weight (net)	826 g

Plug PowerTOP Xtra R	13204
Packaging unit	5 pcs
EAN / identification number	4015394238744

Permissible ambient conditions		
	Min.	Max.
Permanent ambient temperature	-25 °C	40 °C

Material properties	
Cover	PBT/PC squirrel grey [similar RAL 7000]
	TPE anthracite [similar RAL 7016]
Front part	PBT/PC yellow [similar RAL 1021]
	TPE black [similar RAL 9005]
Bayonet ring	PBT/PC squirrel grey [similar RAL 7000]
	TPE anthracite [similar RAL 7016]
Clamp basket	PBT/PC black [similar RAL 9005]
	TPE natural colour [no RAL colour code]
Fastening	PBT/PC squirrel grey [similar RAL 7000]
	TPE anthracite [similar RAL 7016]

Material resistance

The material resistance overview can be found on the website in the section “Knowledge” - “Product knowledge” - “Materials”.

Material and enviromental properties	
RoHS 2011/65/EU incl. 2015/863/EU	✓
POP regulation (EU) 2019/1021	✓

Regulations and Standards

Norm	DIN EN IEC 60309-2
Declaration of Conformity	CE
Test label	CB Zertifikat, VDE, EAC, CQC

Dimensional Drawing



Drawing	Amp. Poles	63			125		
		3	4	5	3	4	5
2 MB 225							
Dim. in mm	a	250	250	250	290	290	290
	b	114	114	114	130	130	130
	y	36	36	36	49	49	49
Terminal for cond. cross		6	6	6	25	25	25
section (mm ²) min.-max.		—16	—16	—16	—50	—50	—50