

ESR5-NE-51-24VAC-DC Safety relay



Powering Business Worldwide

All brand and product names are trademarks or registered trademarks of their respective owners.

Emergency On Call Service

Please call your local representative:

<http://www.eaton.eu/aftersales>

or

Hotline After Sales Service:

+49 (0) 180 5 223822 (de, en)

AfterSalesEGBonn@eaton.com

Original operating manual

The German-language edition of this document is the original operating manual.

Translation of the original operating manual

All editions of this document other than those in German language are translations of the original operating manual.

1. Edition 2019, publication date 12/19

See revision protocol in the "About this manual" chapter.

© 2019 by Eaton Industries GmbH, 53105 Bonn, Germany

Editor: René Wiegand

All rights, including those of translation, reserved.

No part of this manual may be reproduced, stored in a retrieval system, or transmitted in any form or by any means, electronic, mechanical, photocopying, micro-filming, recording, or otherwise, without the prior written permission of Eaton Industries GmbH, Bonn, Germany.

Subject to alteration.



Danger! **Dangerous electrical voltage!**

Before commencing the installation

- Disconnect the power supply of the device.
- Ensure that devices cannot be accidentally retriggered.
- Verify isolation from the supply.
- Ground and short-circuit.
- Cover or enclose neighbouring units that are live.
- Follow the engineering instructions (IL) of the device concerned.
- Only suitably qualified personnel in accordance with EN 50110-1/-2 (VDE 0105 Part 100) may work on this device/system.
- Before installation and before touching the device ensure that you are free of electrostatic charge.
- The functional earth (FE) must be connected to the protective earth (PE) or to the potential equalizing. The system installer is responsible for implementing this connection.
- Connecting cables and signal lines should be installed so that inductive or capacitive interference do not impair the automation functions.
- Install automation devices and related operating elements in such a way that they are well protected against unintentional operation.
- Suitable safety hardware and software measures should be implemented for the I/O connection so that a cable or wire breakage on the signal side does not result in undefined states in the automation device.
- Ensure a reliable electrical isolation of the low voltage for the 24 V supply. Only use power supply units complying with IEC 60364-4-41 or HD 384.4.41 S2 (VDE 0100 part 410).
- Deviations of the mains voltage from the nominal value must not exceed the tolerance limits given in the technical data, otherwise this may cause malfunction and dangerous operation.
- Emergency-Stop devices complying with IEC/EN 60204-1 must be effective in all operating modes of the automation devices. Unlatching the emergency switching off devices must not cause restart.
- Built-in devices for enclosures or cabinets must only be run and operated in an installed state, desk-top devices or portable devices only when the housing is closed.
- Measures should be taken to ensure the proper restart of programs interrupted after a voltage dip or failure. This should not cause dangerous operating states even for a short time. If necessary, emergency switching off devices should be implemented.
- Wherever faults in the automation system may cause damage to persons or property, external measures must be implemented to ensure a safe operating state in the event of a fault or malfunction (for example, by means of separate limit switches, mechanical interlocks, etc.).
- During operation, and depending on their degree of protection, variable frequency drives may have live, uninsulated, moving, and/or rotating parts, as well as hot surfaces.
- The impermissible removal of the required cover, improper installation or incorrect operation of the motor or variable frequency drive can cause the failure of the device and serious injury and/or material damage.
- Comply with all applicable national accident prevention regulations (e.g. BGV A3) when working with energized variable frequency drives.
- The electrical installation must be carried out in accordance with the relevant regulations (e.g. with regard to cable cross sections, fuses, PE).
- All transport, installation, commissioning and maintenance work must only be carried out by trained personnel (observe IEC 60364, HD 384 or DIN VDE 0100 and national accident prevention regulations).
- If applicable, systems in which variable frequency drives are installed must be equipped with additional monitoring and protective devices in accordance with the applicable safety regulations, e.g., the German Equipment and Product Safety Act, accident prevention regulations, etc. Making changes to the variable frequency drives by using the operating software is allowed.
- Keep all covers and doors closed during operation.
- When designing the machine, the user must incorporate mechanisms and measures that limit the consequences of a drive controller malfunction or failure (an increase in motor speed or the motor's sudden stop) so as to prevent hazards to people and property, e.g.:
 - Additional stand-alone devices for monitoring parameters that are relevant to safety (speed, travel, end positions, etc.)
 - Electrical and non-electrical safety devices (interlocks or mechanical locks) for mechanisms that protect the entire system
 - Due to the possibility of there being capacitors that are still holding a charge, do not touch live device parts or terminals immediately after disconnecting the variable frequency drives from the supply voltage. Heed the corresponding labels on the variable frequency drives

Content

0	About This Manual.....	3
0.1	List of revisions	3
0.2	Target group.....	3
0.3	Additional documents	3
0.4	Abbreviations and symbols	4
0.4.1	Risk of material damage.....	4
0.4.2	Hazard warnings of personal injury	4
0.4.3	Tips.....	4
0.5	Ordering data	4
1	Safety notes.....	5
2	Description.....	6
3	Operating and indication elements.....	7
3.1	Connection assignment	7
4	Function description	8
4.1	Contact extension	8
4.2	Single-channel or two-channel wiring	8
4.3	Automatic start.....	8
4.4	Safe shutdown	8
4.5	Function and time diagrams.....	8
5	Basic circuit diagram	9
6	Derating	10
7	Load curve - ohmic load	11
8	Mounting and removing.....	12
9	Wiring.....	13
9.1	Basic device connection.....	14

10	Startup	15
11	Calculating the power dissipation	16
12	Diagnostics	17
13	Application example	18
13.1	Two-channel emergency stop monitoring with contact extension	18
14	Attachment - using devices at altitudes greater than 2000 m above sea level	19
15	Technical data	21
16	Glossary	24

0 About This Manual

This manual applies to the ESR5-NE-51-24VAC-DC safety relay.

0.1 List of revisions

The following significant amendments have been introduced since previous issues:

Publication date	Page	Keyword	new	modified	deleted
12/19		First edition	–	–	–

0.2 Target group

This manual is intended for qualified personnel installing, operating, and maintaining the ESR5-NE-51-24VAC-DC safety relay.



CAUTION

Installation requires a qualified electrician

0.3 Additional documents

For further information, see the following documentation:

- Instruction leaflet IL05013035Z2018_06

WARNING

Make sure you always use the latest documentation.

It can be downloaded from the product at: www.eaton.eu/esr5

0.4 Abbreviations and symbols

The symbols used in this manual have the following meanings:

- ▶ indicates actions to be taken.

0.4.1 Risk of material damage

CAUTION

Warns about the possibility of material damage.

0.4.2 Hazard warnings of personal injury



CAUTION

Warns of the possibility of hazardous situations that may possibly cause slight injury.



WARNING

Warns of the possibility of hazardous situations that could result in serious injury or even death.



DANGER

Warns of hazardous situations that result in serious injury or death.

0.4.3 Tips



Indicates useful tips.

0.5 Ordering data

ESR5-NE-51-24VAC-DC safety relay: Catalog No. 118707

1 Safety notes



WARNING

Risk of electric shock

During operation, parts of electrical switching devices carry hazardous voltages.

Before working on the switching device, disconnect the power. Please observe the safety regulations of electrical engineering and industrial safety and liability associations!

Disregarding these safety regulations may result in death, serious personal injury or damage to equipment.

Startup, mounting, modifications, and upgrades should only be carried out by a skilled electrical engineer!



WARNING

Risk of automatic machine restart!

For emergency stop applications, the machine must be prevented from restarting automatically by a higher-level control system.

Protective covers must not be removed when operating electrical switching devices.



WARNING

Danger due to faulty devices!

The devices may be damaged following an error and correct operation can no longer be ensured.

In the event of an error, replace the device immediately.

Repairs to the device, especially if the housing must be opened, may only be carried out by the manufacturer or authorized persons. Otherwise the warranty is invalidated.

CAUTION

Risk of damage to equipment due to incorrect installation

For reliable operation, the safety relay must be installed in housing protected from dust and humidity (IP54).

Carry out wiring according to the application.

Refer to the "Application examples" section for this.

CAUTION

Risk of damage to equipment due to noise emissions

When operating relay modules the operator must meet the requirements for noise emission for electrical and electronic equipment (EN 61000-6-4) on the contact side and, if required, take appropriate measures.

2 Description

Intended Use

The ESR5-NE-51-24VAC-DC safety relay is used as a contact extension for safety relays for the emergency stop and safety door monitoring.

The safety relay interrupts circuits in a safety-related way.

Possible signal generators

- Safety relays

Contact type

- 5 undelayed enabling current paths
- 1 undelayed confirmation current path
- 1 undelayed enabling current path

The enabling current paths, the confirmation current path, and the signaling current path drop out without delay according to stop category 0 (EN 60204-1).

Control

- Single or two channel
- Automatic start

Achievable safety integrity

- Suitable up to category 4, PL e (EN ISO 13849-1), SILCL 3 (EN 62061) in conjunction with an appropriate evaluation device

Additional features

- Screw terminal blocks for plug-in
- 22.5 mm housing width

Approvals



3 Operating and indication elements

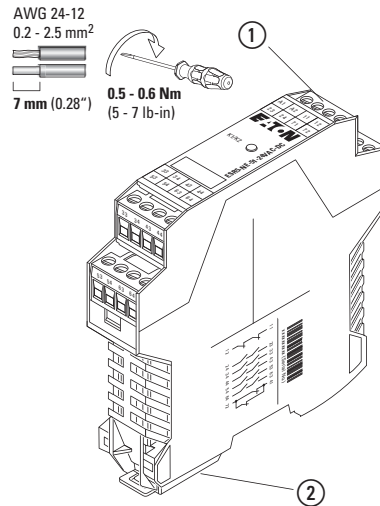

Figure 1: ESR5-NE-51-24VAC-DC
 ① COMBICON plug-in screw terminal block
 ② Metal lock for fixing to DIN rail

3.1 Connection assignment

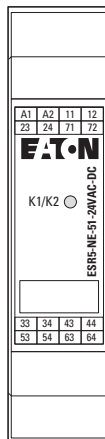

Figure 2: Connection assignment
 A1 - 24 V AC/DC control
 A2 - 0 V control
 11/12 - Confirmation current path, undelayed
 23/24 - Enabling current path, undelayed
 71/72 - Signaling current path, undelayed
 K1/K2 - Status indicator safety circuit; LED (green)
 33/34, 43/44, 53/54, 63/64 - Undelayed enabling current paths

4 Function description

4.1 Contact extension

The device provides additional output contacts for safe shutdown for a suitable basic device.

4.2 Single-channel or two-channel wiring

The external enable signal of the basic device is connected to A1.

The external enable signal of the basic device can also be optionally connected to A2.

4.3 Automatic start

The device starts automatically once it has received the external enable signal of the basic device.

4.4 Safe shutdown

Once the external enable signal of the basic device has been deactivated, the enabling current paths open without delay.

When the enabling current paths are open, the device is in the safe state.

The confirmation current path and signaling current path close.

4.5 Function and time diagrams

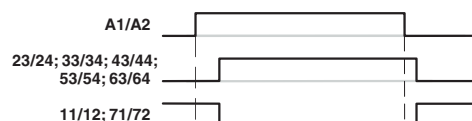

Figure 3: Time diagram for automatic start

A1/A2 - Control

23/24, 33/34, 43/44, 53/54, 63/64 - Undelayed enabling current pathst

11/12, 71/72 - (Confirmation) signaling current paths

5 Basic circuit diagram

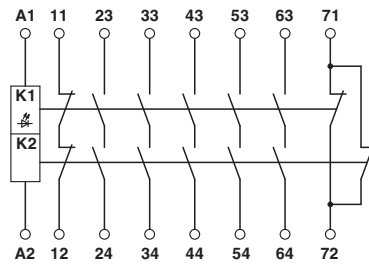

Figure 4: Block diagram

Designation	Explanation
A1	24 V AC/DC control
A2	0 V control
11/12	Confirmation current path, undelayed
23/24 , 33/34, 43/44, 53/54, 63/64	Undelayed enabling current paths
71/72	Signaling current path, undelayed

6 Derating

The derating curve applies for the following conditions:

- Mounting on a vertical or horizontal DIN rail
- Devices mounted next to each other without spacing

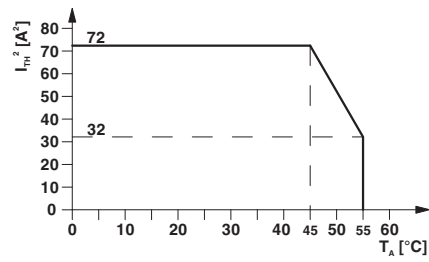

Figure 5: Derating curve - vertical or horizontal mounting position, without spacing

7 Load curve - ohmic load

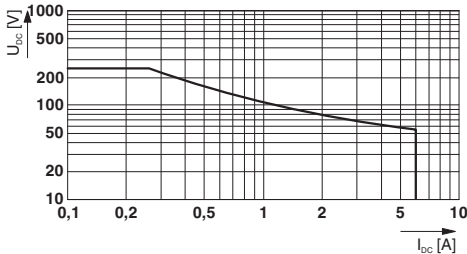

Figure 6: Relay load curve - ohmic load

8 Mounting and removing

- ▶ Mount the device on a 35 mm DIN rail according to EN 60715.
- ▶ To remove the device, use a screwdriver to release the snap-on foot.

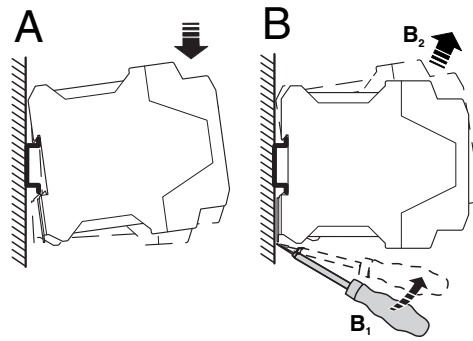

Figure 7: Mounting and removing

9 Wiring

- ▶ Connect the cables to the connection terminal blocks using a screwdriver.

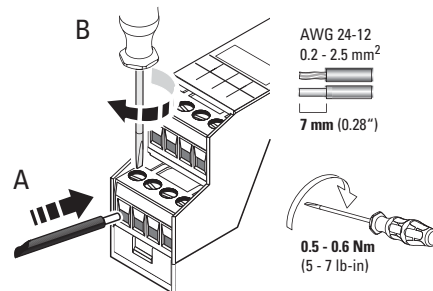

Figure 8: Connecting the cables



It is recommended that ferrules are used to connect stranded cables.



For compliance with UL approval, use copper wire that is approved up to 60 °C/75 °C.

9.1 Basic device connection

- ▶ Connect the basic device to A1.
- ▶ Install confirmation current path 11/12 in the feedback circuit of the basic device.

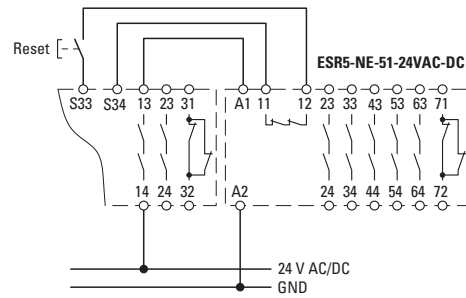

Figure 9: Single-channel connection with integration of the confirmation current path

- ▶ Place the relevant N/C contact in the path from 11/12 to the basic device to monitor external contactors or extension devices with force-guided contacts.

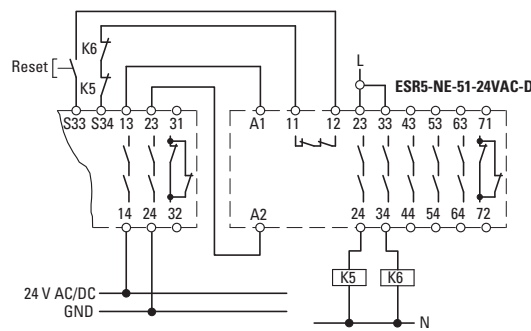

Figure 10: Two-channel connection with integration of the confirmation current path and externally monitored contacts

10 Startup

- ▶ Provide the external enable signal (24 V AC/DC) at terminal block A1.
 - The K1/K2 LED lights up.
 - The enabling current paths 23/24, 33/34, 43/44, 53/54, and 63/64 lose.
 - Confirmation current path 11/12 and signaling current path 71/72 open.

11 Calculating the power dissipation



The total power dissipation of the safety relay is based on the input power dissipation and the contact power dissipation for the same and for different load currents.

Input power dissipation

$$P_{\text{Input}} = U_B^2 / (U_N / I_N)$$

Contact power dissipation

With the same load currents:

$$P_{\text{Contact}} = n \times I_L^2 \times 200 \text{ m}\Omega$$

With different load currents:

$$P_{\text{Contact}} = (I_{L1}^2 + I_{L2}^2 + \dots + I_{Ln}^2) \times 200 \text{ m}\Omega$$

Total power dissipation

$$P_{\text{Total}} = P_{\text{Input}} + P_{\text{Contact}}$$

therefore

$$P_{\text{Total}} = U_B^2 / (U_N / I_N) + n \times I_L^2 \times 200 \text{ m}\Omega$$

or

$$P_{\text{Total}} = U_B^2 / (U_N / I_N) + (I_{L1}^2 + I_{L2}^2 + \dots + I_{Ln}^2) \times 200 \text{ m}\Omega$$

- P** Power dissipation in mW
- U_B** Applied operating voltage
- U_N** Nominal input voltage
- I_N** Input current
- n** Number of enabling current paths used
- I_L** Contact load current

12 Diagnostics

○ – LED off

● – LED on

Table 1: Diagnostic description

	K1/K2	Fault	Remedy
Connection/ voltage error	○	Supply voltage not present.	Apply supply voltage.
	○	Supply voltage too low.	Adjust supply voltage.
	○	The input circuit is connected incorrectly or not connected at all.	Check the input circuit connection
Short circuit	○	Between contact points A1 and A2.	Remove short circuit.
Fault with internal cause	○	Checkback contacts 11 and 12 faulty.	Replace safety relays.
	○	Enable contact(s) of K1 and K2 faulty.	Perform a voltage reset.

Function test/proof test



Use the function test to test the safety function. To do this, request the safety function once via the basic device by pressing the emergency stop button, for example. Check whether the safety function is executed correctly by then switching the basic device and thereby also the contact extension on again.

13 Application example

13.1 Two-channel emergency stop monitoring with contact extension

- Manual, monitored start
- Monitoring of external contactors
- Suitable up to category 4, PL e (EN ISO 13849-1), SIL 3 (EN 62061), if cross-circuits can be ruled out in the control for contact extension

➔ Cross-circuits in the cable installation can be excluded if the safety relay and the contact extension are located in the same electrical installation space.

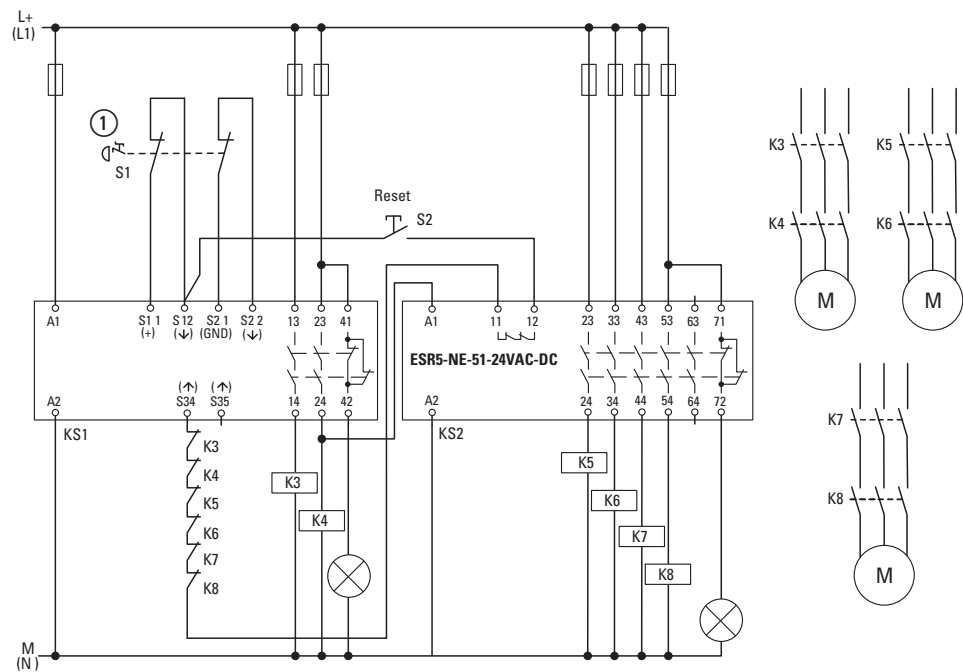

Figure 11: Two-channel emergency stop monitoring with contact extension

S1 - Emergency stop button

K3, ..., K8 - Contactors

14 Attachment - using devices at altitudes greater than 2000 m above sea level



The following section describes the special conditions for using ESR5-NE-51-24VAC-DC devices at altitudes greater than 2000 m above sea level.

Observe the relevant device-specific data (technical data, derating, etc.) according to the product documentation for the individual device.

Using the device at altitudes **greater than 2000 m above sea level up to max. 4500 m above sea level** is possible under the following conditions:

- ▶ 1. Limit the nominal input voltage (U_N) in accordance with the table below. Observe the technical data for the device.

U_N according to the technical data for the device	U_N when used at altitudes greater than 2000 m above sea level
< 150 V AC/DC	U_N according to the technical data for the device still valid
> 150 V AC/DC	Limited to max. 150 V AC/DC

- ▶ 2. Limit the maximum switching voltage in accordance with the table below. Observe the technical data for the device.

Max. switching voltage according to the technical data for the device	Max. switching voltage when used at altitudes greater than 2000 m above sea level
< 150 V AC/DC	U_N according to the technical data for the device still valid
> 150 V AC/DC	Limited to max. 150 V AC/DC

- ▶ 3. Reduce the maximum ambient temperature for operation by the corresponding factor in accordance with the table below.
- ▶ 4. If derating is specified, offset all the points of the derating curve by the corresponding factor in accordance with the table below.

Altitude above sea level	Temperature derating factor
2000 m	1
2500 m	0.953
3000 m	0.906
3500 m	0.859
4000 m	0.813
4500 m	0.766

Example calculation for 3000 m



The following calculation and the illustrated derating curve are provided as examples. Perform the actual calculation and offset the derating curve for the device used according to the technical data and → section 6, "Derating", page 10.

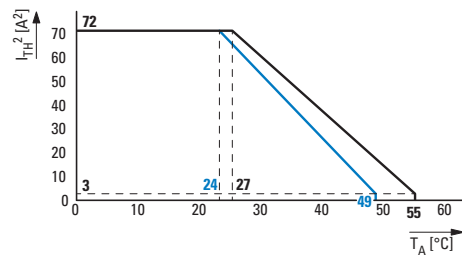

Figure 12: Example of a suspended derating curve (blue)



$$27\text{ °C} \times 0,906 = 24\text{ °C}$$

$$55\text{ °C} \times 0,906 = 49\text{ °C}$$

15 Technical data

Input data	
Nominal input voltage U_N	24 V AC/DC -15 % / +10 %
Typical input current	81 mA AC 71 mA DC
Typical inrush current	175 mA ($\Delta t = 5$ ms at U_N)
Power consumption at U_N , typical	1.94 W (AC) 1.7 W (DC)
Filter time	2 ms (at A1 in the event of voltage dips at U_N)
Typical starting time with U_N	< 20 ms (when controlled via A1)
Typical release time with U_N	< 20 ms (when controlled via A1)
Recovery time	< 1 s
Maximum switching frequency	1 Hz
Operating voltage display	LED, green
Protective circuit	Surge protection Varistor
Output data	
Contact type	5 enabling current paths 1 confirmation current path 1 signaling current path
Contact material	AgSnO ₂
Minimum switching voltage	5 V AC/DC
Maximum switching voltage	250 V AC/DC (Observe the load curve)
Limiting continuous current	6 A (N/O contact, pay attention to the derating) 6 A (N/C contact)
Maximum inrush current	20 A ($\Delta t \leq 100$ ms)
Inrush current, minimum	10 mA
Sq. Total current $(I_{TH})^2 = (I_1)^2 + (I_2)^2 + (I_3)^2$	72 A ² (see derating curve, → Figure 6, page 10)
Interrupting rating (ohmic load) max.	144 W (24 V DC, $\tau = 0$ ms) 288 W (48 V DC, $\tau = 0$ ms) 110 W (110 V DC, $\tau = 0$ ms) 88 W (220 V DC, $\tau = 0$ ms) 1500 VA (250 V AC, $\tau = 0$ ms)
Maximum interrupting rating (inductive load)	42 W (24 V DC, $\tau = 40$ ms) 42 W (48 V DC, $\tau = 40$ ms) 42 W (110 V DC, $\tau = 40$ ms) 42 W (220 V DC, $\tau = 40$ ms)
Switching capacity min.	50 mW
Mechanical service life	~ 10 ⁷ cycles
Switching capacity (360 cycles/h)	4 A (24 V DC) 4 A (230 V AC)
Switching capacity (3600 cycles/h)	2,5 A (24 V (DC-13)) 3 A (230 V (AC-15))
Output fuse	10 A gL/gG NEOZED (N/O contact) 6 A gL/gG NEOZED (N/C contact)

15 Technical data

General data	
Relay type	Electromechanically forcibly guided, dust-proof relay
Nominal operating mode	100 % operating factor
Degree of protection	IP20
Min. degree of protection of inst. location	IP54
Mounting position	any
Mounting type	DIN rail mounting
Air and creepage distances between the power circuits	DIN EN 50178/VDE 0160
Rated insulation voltage	250 V
Rated surge voltage / insulation	Basic insulation 4 kV: between all current paths and housing Safe isolation, reinforced insulation 6 kV: between A1/A2, 11/12, 23/24, 71/72 and 33/34, 43/44, 53/54, 63/64
Pollution degree	2
Surge voltage category	III
Dimensions	
W x H x D	22.5 x 99 x 114.5 mm
Connection data	
Conductor cross section, solid	0.2 mm ² - 2.5 mm ²
Conductor cross section, stranded	0.2 mm ² - 2.5 mm ²
Conductor cross section AWG/kcmil	24 - 12
Stripping length	7 mm
Screw thread	M3
Ambient conditions	
Ambient temperature (operation)	-20 °C - 55 °C (Observe derating)
Ambient temperature (storage/transport)	-40 °C - 70 °C
Maximum permissible relative humidity (operation)	75 % (on average, 85 % infrequently, non-condensing)
Maximum permissible humidity (storage/transport)	75 % (on average, 85 % infrequently, non-condensing)
Altitude	max. 2000 m (above sea level)
Shock	15 g
Vibration (operation)	10 Hz -150 Hz, 2 g
Conformance / Approvals	
Conformance	CE-compliant
Approvals	   <div style="display: inline-block; vertical-align: middle; font-size: 8px;"> Product Safety SIL/PL Capability <small>www.tuv.com ID: 9500000000</small> </div>
Safety data	
Stop category according to IEC 60204	0

Safety parameters for IEC 61508 - High demand

SIL	3 (in conjunction with suitable evaluating device)
PFH _d	1.02 x 10 ⁻¹⁰ per hour
Demand rate	< 12 months
Proof test interval	240 months
Duration of use	240 months

The specifications apply assuming the following calculation basis:

B _{10d}	230000 (at 3 A AC-15)
d _{op}	365.25 days
h _{op}	24 h
t _{Cycle}	3600 s

Safety parameters for IEC 61508 - Low demand

SIL	3 (in conjunction with suitable evaluating device)
PFD _{avg}	1.50 x 10 ⁻⁴
Proof test interval	84 months
Duration of use	240 months

Safety characteristic data according to EN ISO 13849

Category	4 (in conjunction with suitable evaluating device)
Performance Level	e (in conjunction with suitable evaluating device)
Duration of use	240 months

For applications in PL e, the required demand rate for the safety function is once per month.

The specifications apply assuming the following calculation basis:

B _{10d}	230000 (at 3 A AC-15)
d _{op}	365.25 days
h _{op}	24 h
t _{Zyklus}	3600 s

Safety parameters for EN 62061

SILCL	3 (in conjunction with suitable evaluating device)
-------	--

16 Glossary

Abbreviation	Explanation
AOPD	<p>Active optoelectronic protective device Device with a sensor function that is generated by optoelectronic transmit and receive elements, which detects the interruption of optical radiation generated in the device by an opaque object located in the specified protective field (or for a photoelectric barrier on the axis of the light beam).</p> <p>In DIN EN 692 (mechanical presses), DIN EN 693 (hydraulic presses), and EN 12622 (hydraulic trimming presses), the abbreviation AOS is used as a synonym for AOPD.</p>
AOPDDR	<p>Active optoelectronic protective device responsive to diffuse reflection Device with a sensor function that is generated by optoelectronic transmit and receive elements, which detects the diffuse reflection of optical radiation generated in the device by an object located in a protective field specified in two dimensions.</p>
Cat. / Category	Classification of the resistance to faults according to EN ISO 13849-1.
CCF	Common cause failure
DC	Diagnostic coverage
ESPE	Electro-sensitive protective equipment
Mission Time T_M	Duration of use
MTTF / $MTTF_d$	Mean time to failure / mean time to dangerous failure
PFD	Probability of failure on demand (low demand)
PFH_d	Average frequency of a dangerous failure per hour
PL	<p>Performance level Classification of the ability of safety functions to meet a safety demand</p>
SIL	Safety integrity level
SILCL	SIL claim limit
SRCF	Safety-related control function
SRECS	<p>Safety-related electrical control system (Safety-related electrical, electronic, and programmable electronic control system)</p>
SRP	Safety-related part
SRP/CS	Safety-related parts of control system