

SPIROTECH SPECIFICATION SHEET



Product: SpiroTrap Rp1 1/4" Threaded fitting

Type:

AE125

Date:

11/19/2019

Customer:

Project:

Reference:

Design criteria

Medium:	Water / glycol (max 50%)	
Max. flow velocity:	1	m/s
Max. flow rate:	3.60	m ³ /h
Max. pressure:	10	bar-g
Max. temperature:	110	°C
Design standard:	EN 13445	

Testing and quality assurance

Leakage test:	no
Test certificate:	no
Design and manufacturing acc. 2014/68/EU:	yes
Material certificates (structural parts):	no
Drawing:	no

Construction materials

Body:	Brass
Drain valve:	Brass
Spirotube Tube:	S235 JR G2 (St.37)
Spirotube Wire:	Copper
Spirotube Solder:	Tin(SnCu3)

Drawing

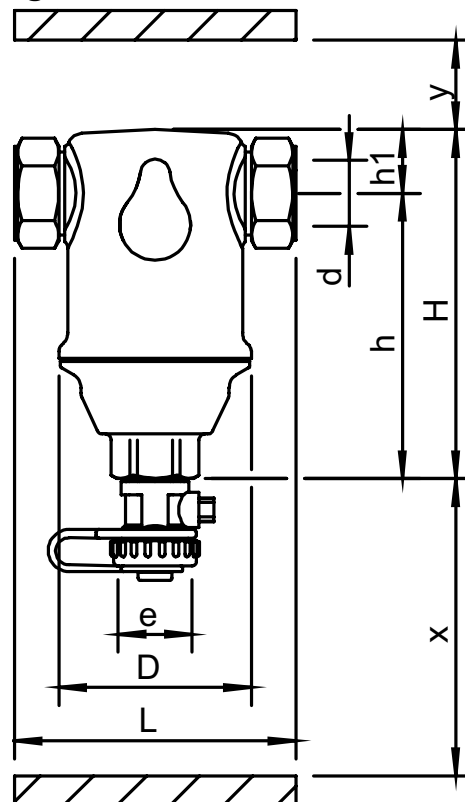

Dimensions

d:	Rp1 1/4"
H:	161 mm
h:	122 mm
h1:	39 mm
L:	88 mm
D:	65 mm
x:	>70 mm
y:	>50 mm
e:	G3/4

Volume 0.25 ltr

Dry weight (approx) 1.4 kg

Subject to changes