

## Data Sheet | Item Number: 862-9533

4-conductor chassis-mount terminal strip; with ground contact; PE-N-L1; 3-pole; 1 snap-in foot per pole; 4 mm<sup>2</sup>; black

<https://www.wago.com/862-9533>

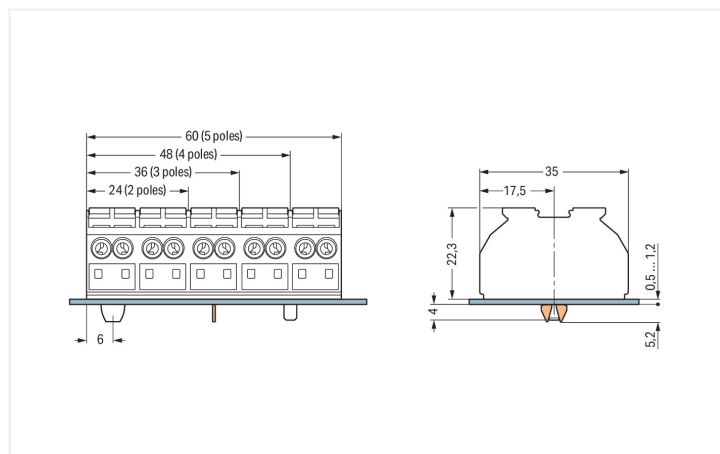

Color: ■ black

Similar to illustration

Dimensions in mm

Dimensions in mm for chassis-mount terminal strips



Dimensions in mm for PE contact and snap-in mounting foot (Ø 5.2 mm)

### Chassis-mount terminal strip, 862 Series, black

Our chassis-mount terminal strip (item number 862-9533) simplifies electrical installations. Ensure that the strip lengths are between 10 and 11 mm when connecting conductors to this chassis-mount terminal strip. This product features conductor terminals and utilizes Push-in CAGE CLAMP®. Our Push-in CAGE CLAMP® is a universal, maintenance-free connection solution for all conductor types, boasting a key feature: both solid and fine-stranded conductors with ferrules can be directly inserted without the need for tools or any preparation, such as crimping the ferrule. Dimensions: (36 x 27.5 x 35) mm (width x height x depth). Depending on the conductor type, this chassis-mount terminal strip is ideal for conductor cross sections ranging from 0.5 mm<sup>2</sup> to 4 mm<sup>2</sup>.

#### Electrical data

##### Ratings per IEC/EN

Nominal voltage (III/3)	500 V
Rated impulse withstand voltage (III / 3)	6 kV
Rated current	32 A
Legend (ratings)	(III / 3) ≙ Overvoltage category III / Pollution degree 3

##### General information

Wiring direction	Side-entry wiring
------------------	-------------------

## Connection Data

Clamping units	12
Total number of potentials	3
PE function	with ground contact

## Connection 1

Connection technology	Push-in CAGE CLAMP®
Actuation type	Push-button
Connectable conductor materials	Copper
Solid conductor	0.5 ... 4 mm <sup>2</sup> / 20 ... 12 AWG
Solid conductor; push-in termination	0.75 ... 4 mm <sup>2</sup> / 18 ... 12 AWG
Stranded conductor	0.5 ... 4 mm <sup>2</sup> / 20 ... 12 AWG
Fine-stranded conductor	0.5 ... 4 mm <sup>2</sup> / 20 ... 12 AWG
Fine-stranded conductor; with insulated ferrule	0.5 ... 1.5 mm <sup>2</sup> / 20 ... 16 AWG
Fine-stranded conductor; with ferrule; push-in termination	0.75 ... 1.5 mm <sup>2</sup> / 18 ... 16 AWG
Note (conductor cross-section)	Depending on the conductor characteristic, a conductor with a smaller cross-section can also be inserted via push-in termination.
Strip length	10 ... 11 mm / 0.39 ... 0.43 inches
Pole number	3

## Physical data

Pin spacing	12 mm / 0.472 inches
Width	36 mm / 1.417 inches
Height	27.5 mm / 1.083 inches
Height from the surface	22.3 mm / 0.878 inches
Depth	35 mm / 1.378 inches

## Mechanical data

Marking	⊕-N-L1
Mounting type	Snap-in foot

## Material data

Note (material data)	<a href="#">Information on material specifications can be found here</a>
Color	black
Material group	I
Insulation material (main housing)	Polyamide (PA66)
Flammability class per UL94	V0
Fire load	0.39 MJ
Halogen-free	Yes
Weight	21.6 g

## Commercial data

PU (SPU)	250 pcs
Packaging type	Bag
Country of origin	DE
GTIN	4044918510981
Customs tariff number	85369010000

### Product Classification

UNSPSC	39121410
eCl@ss 10.0	27-14-11-06
eCl@ss 9.0	27-14-11-06
ETIM 9.0	EC001284
ETIM 10.0	EC001284
ECCN	NO US CLASSIFICATION

### Environmental Product Compliance

RoHS Compliance Status	Compliant, No Exemption
------------------------	-------------------------

### Approvals / Certificates

#### General approvals



Approval	Standard	Certificate Name
CCA DEKRA Certification B.V.	EN 60947	NTR NL 6912
CSA DEKRA Certification B.V.	C22.2 No. 158	1505030
ENEC 15 UL International Germany GmbH	EN 60998	143856-01
KEMA/KEUR DEKRA Certification B.V.	EN 60947	2146425.01
UL UL International Germany GmbH	UL 1059	E45172

#### Declarations of conformity and manufacturer's declarations

Approval	Standard	Certificate Name
EU-Declaration of Conformity WAGO GmbH & Co. KG	-	-
UK-Declaration of Conformity WAGO GmbH & Co. KG	-	-

### Approvals for marine applications



Approval	Standard	Certificate Name
DNV GL Det Norske Veritas, Germanischer Lloyd	-	TAE00001V2
PRS Polski Rejestr Statków	-	TE/1094/880590/23

### Downloads

#### Environmental Product Compliance

##### Compliance Search

Environmental Product Compliance 862-9533



## Documentation

Bid Text			
862-9533	19.02.2019	xml 3.61 KB	<a href="#">↓</a>
862-9533	12.06.2017	doc 24.50 KB	<a href="#">↓</a>

## CAD/CAE-Data

CAD data	
2D/3D Models 862-9533	<a href="#">↓</a>







CAE data	
EPLAN Data Portal 862-9533	<a href="#">↓</a>
WSCAD Universe 862-9533	<a href="#">↓</a>
ZUKEN Portal 862-9533	<a href="#">↓</a>

## 1 Compatible Products

### 1.1 Optional Accessories

#### 1.1.1 Ferrule

##### 1.1.1.1 Ferrule

 <a href="#">Item No.: 216-241</a> Ferrule; Sleeve for 0.5 mm <sup>2</sup> / 20 AWG; insulated; electro-tin plated; electrolytic copper; gastight crimped; acc. to DIN 46228, Part 4/09.90; white	 <a href="#">Item No.: 216-141</a> Ferrule; Sleeve for 0.5 mm <sup>2</sup> / 20 AWG; un-insulated; electro-tin plated; electrolytic copper; gastight crimped; acc. to DIN 46228, Part 1/08.92	 <a href="#">Item No.: 216-242</a> Ferrule; Sleeve for 0.75 mm <sup>2</sup> / 18 AWG; insulated; electro-tin plated; electrolytic copper; gastight crimped; acc. to DIN 46228, Part 4/09.90; gray	 <a href="#">Item No.: 216-142</a> Ferrule; Sleeve for 0.75 mm <sup>2</sup> / 18 AWG; un-insulated; electro-tin plated; electrolytic copper; gastight crimped; acc. to DIN 46228, Part 1/08.92
 <a href="#">Item No.: 216-243</a> Ferrule; Sleeve for 1 mm <sup>2</sup> / AWG 18; insulated; electro-tin plated; electrolytic copper; gastight crimped; acc. to DIN 46228, Part 4/09.90; red	 <a href="#">Item No.: 216-143</a> Ferrule; Sleeve for 1 mm <sup>2</sup> / AWG 18; un-insulated; electro-tin plated; electrolytic copper; gastight crimped; acc. to DIN 46228, Part 1/08.92	 <a href="#">Item No.: 216-244</a> Ferrule; Sleeve for 1.5 mm <sup>2</sup> / AWG 16; insulated; electro-tin plated; electrolytic copper; gastight crimped; acc. to DIN 46228, Part 4/09.90; black	 <a href="#">Item No.: 216-144</a> Ferrule; Sleeve for 1.5 mm <sup>2</sup> / AWG 16; un-insulated; electro-tin plated; electrolytic copper; gastight crimped; acc. to DIN 46228, Part 1/08.92; silver-colored

### 1.1.2 Jumper

#### 1.1.2.1 Jumper



<a href="#">Item No.: 862-482</a> Jumper; for conductor entry; insulated; black
--

### 1.1.3 Marking

#### 1.1.3.1 Marking strip



**Item No.: 709-177**

Marking strips; on reel; 7.5 mm wide; not stretchable; plain; snap-on type; translucent

**Item No.: 709-178**

Marking strips; on reel; 7.5 mm wide; not stretchable; plain; snap-on type; white

### 1.1.4 Test and measurement

#### 1.1.4.1 Testing accessories



**Item No.: 210-136**

Test plug; 2 mm Ø; with 500 mm cable; red

### 1.1.5 Tool

#### 1.1.5.1 Operating tool



**Item No.: 210-720**

Operating tool; Blade: 3.5 x 0.5 mm; with a partially insulated shaft; multicoloured

### Installation Notes

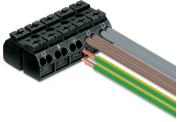
**Cost-effective features:**

WAGO's 862 Series Chassis-Mount Terminal Strips were developed specifically to minimize wiring costs, while accommodating requirements for flexible mounting, multiple connection points and easy usage:

- Equipped with Push-in CAGE CLAMP®, the 862 Series connects up to four conductors sized 0.5 to 4 mm<sup>2</sup> (20 ... 12 AWG). Due to multiple connection points per pole, different conductor sizes can be used within the same terminal block position.
- For factory wiring, Push-in CAGE CLAMP® Connection Technology allows solid conductors, fine-stranded conductors with ferrules or ultrasonically bonded conductors from 0.5 ... 4 mm<sup>2</sup> (20 ... 12 AWG) to be terminated by simply pushing them into unit (length of bonded conductor end: min. 10 mm).
- Convenient automatic grounding contact (optional)
- Snap-in mounting feet for fast assembly
- Push-buttons for easy installation with an operating tool or by hand
- Built-in test points simplify testing with 2 mm Ø test plug
- Standard marking for each pole, or custom marking for large orders

**Conductor termination**

Terminating four conductors per pole – solid and fine-stranded.

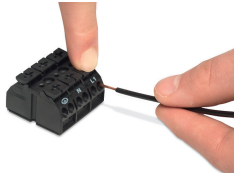

Inserting a conductor via push-button.

**Commoning**

Commoning using a comb-style jumper bar (862-482).

## Testing



Testing with a 2 mm Ø test plug (max. 42 V).



Dimensions in mm

## Marking



Marking by direct, one-side printing and marking strips