

## Data Sheet | Item Number: 2734-107

1-conductor female connector; push-button; Push-in CAGE CLAMP®; 1.5 mm²; Pin spacing 3.5 mm; 7-pole; 100% protected against mismatching; 1,50 mm²; light gray

<https://www.wago.com/2734-107>

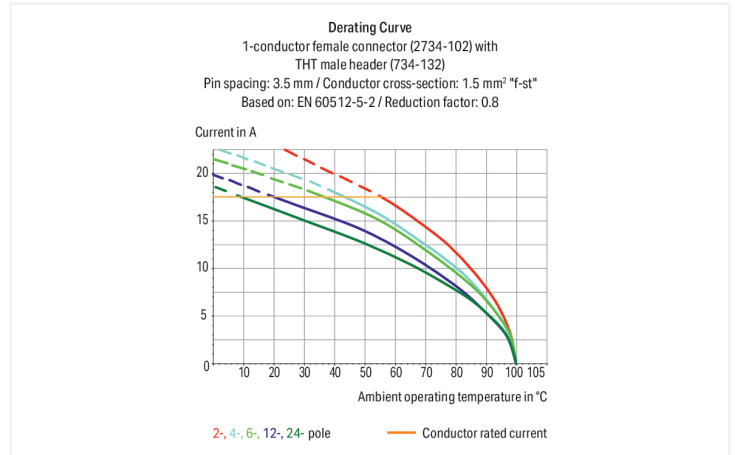

Color: ■ light gray

Similar to illustration

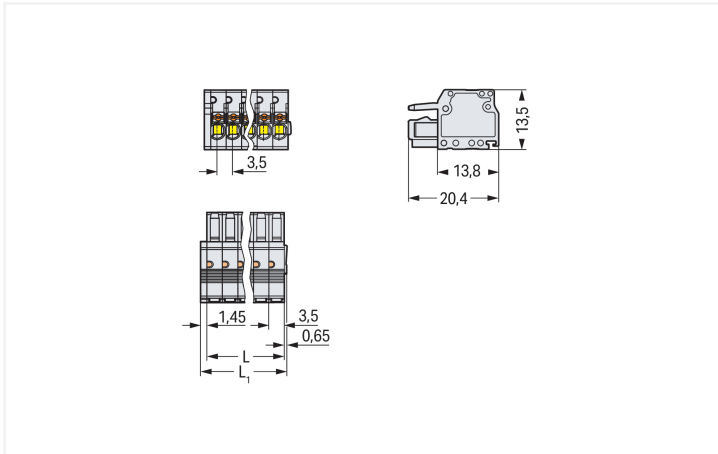

Dimensions in mm

L = pole no. x pin spacing  
L1 = (pole no. x pin spacing) + 2.1 mm

Female connector, 2734 Series, light gray

This female connector (item number 2734-107) simplifies electrical installations. Strip lengths must be between 8 and 9 mm when connecting conductors to this female connector. Featuring one conductor terminal along with Push-in CAGE CLAMP®, this product is highly versatile. Push-in CAGE CLAMP® connection technology is ideal for connecting all conductor types. Both solid and fine-stranded conductors with ferrules can be pushed in without the need for tools—all thanks to its pluggable design. Dimensions: (26.6 x 13.5 x 20.4) mm (width x height x depth). Depending on the conductor type, this female connector is designed for conductor cross sections ranging from 0.2 mm² to 1.5 mm².

Tin is used for coating the contact surfaces.

## Notes

## Safety Information

The MCS – MULTI CONNECTION SYSTEM includes connectors without breaking capacity in accordance with DIN EN 61984. When used as intended, these connectors must not be connected/disconnected when live or under load. When used as intended, these connectors must not be connected/disconnected when live or under load. The circuit design should ensure header pins, which can be touched, are not live when unmated.

## Variants:

Other pole numbers  
Gold-plated or partially gold-plated contact surfaces  
Other versions (or variants) can be requested from WAGO Sales or configured at <https://configurator.wago.com/>.

## Electrical data

Ratings per	IEC/EN 60664-1			Approvals per	UL 1059		
	III	III	II		Use group	B	C
Overvoltage category	III	III	II	Use group	B	C	D
Pollution degree	3	2	2	Rated voltage	300 V	-	300 V
Nominal voltage	160 V	160 V	320 V	Rated current	10 A	-	10 A
Rated impulse withstand voltage	2.5 kV	2.5 kV	2.5 kV				
Rated current	10 A	10 A	10 A				

Approvals per	CSA		
Use group	B	C	D
Rated voltage	300 V	-	300 V
Rated current	10 A	-	10 A

## Connection Data

Clamping units	7	<b>Connection 1</b>	
Total number of potentials	7	Connection technology	Push-in CAGE CLAMP®
Number of connection types	1	Actuation type	Push-button
Number of levels	1	Actuation direction 1	Operation parallel to conductor entry
		Solid conductor	0.2 ... 1.5 mm <sup>2</sup> / 24 ... 16 AWG
		Fine-stranded conductor	0.2 ... 1.5 mm <sup>2</sup> / 24 ... 16 AWG
		Fine-stranded conductor; with insulated ferrule	0.25 ... 0.75 mm <sup>2</sup>
		Fine-stranded conductor; with uninsulated ferrule	0.25 ... 1.5 mm <sup>2</sup>
		Strip length	8 ... 9 mm / 0.31 ... 0.35 inches
		Pole number	7
		Conductor entry direction to mating direction	0°

## Physical data

Pin spacing	3.5 mm / 0.138 inches
Width	26.6 mm / 1.047 inches
Height	13.5 mm / 0.531 inches
Depth	20.4 mm / 0.803 inches

### Mechanical data

Variable coding	Yes
Anti-rotation protection	Yes

### Plug-in connection

Contact type (pluggable connector)	Female connector/socket
Connector (connection type)	for conductor
Mismating protection	Yes

### Material data

Note (material data)	<a href="#">Information on material specifications can be found here</a>
Color	light gray
Material group	I
Insulation material (main housing)	Polyamide (PA66)
Flammability class per UL94	V0
Clamping spring material	Chrome-nickel spring steel (CrNi)
Contact material	Copper alloy
Contact Plating	Tin
Fire load	0.111 MJ
Weight	6.2 g

### Environmental requirements

Limit temperature range	-60 ... +100 °C
Processing temperature	-35 ... +60 °C

### Commercial data

Product Group	3 (Multi Conn. System)
PU (SPU)	100 pcs
Packaging type	Box
Country of origin	PL
GTIN	4055143280228
Customs tariff number	85366990990

### Product Classification

UNSPSC	39121409
eCl@ss 10.0	27-44-03-09
eCl@ss 9.0	27-44-03-09
ETIM 9.0	EC002638
ETIM 10.0	EC002638
ECCN	NO US CLASSIFICATION

**Environmental Product Compliance**

RoHS Compliance Status Compliant, No Exemption

**Approvals / Certificates**

**General approvals**



Approval	Standard	Certificate Name
CCA DEKRA Certification B.V.	IEC 61984	NL-23611
CCA DEKRA Certification B.V.	EN 61984	2147056.01
CSA DEKRA Certification B.V.	C22.2 No. 158	2314554
UL Underwriters Laboratories Inc.	UL 1977	E 45171

**Downloads**

**Environmental Product Compliance**

**Compliance Search**

Environmental Product Compliance 2734-107 [↓](#)

**Documentation**

**Additional Information**

Technical Section 03.04.2019 pdf 2027.26 KB [↓](#)

**CAD/CAE-Data**

**CAD data**

2D/3D Models 2734-107 [↓](#)

**CAE data**

ZUKEN Portal 2734-107 [↓](#)

## 1 Compatible Products

### 1.1 System counterpart

#### 1.1.1 Male connector/plug



**Item No.: 734-307**

1-conductor male connector; CAGE CLAMP®; 1.5 mm<sup>2</sup>; Pin spacing 3.5 mm; 7-pole; 100% protected against mismatching; 1,50 mm<sup>2</sup>; light gray

**Item No.: 734-167**

THT male header; 1.0 x 1.0 mm solder pin; angled; 100% protected against mismatching; Pin spacing 3.5 mm; 7-pole; light gray

**Item No.: 734-137**

THT male header; 1.0 x 1.0 mm solder pin; straight; 100% protected against mismatching; Pin spacing 3.5 mm; 7-pole; light gray

## 1.2 Optional Accessories

### 1.2.1 Ferrule

#### 1.2.1.1 Ferrule



**Item No.: 216-301**

Ferrule; Sleeve for 0.25 mm<sup>2</sup> / AWG 24; insulated; electro-tin plated; yellow

**Item No.: 216-302**

Ferrule; Sleeve for 0.34 mm<sup>2</sup> / 22 AWG; insulated; electro-tin plated; light turquoise

**Item No.: 216-201**

Ferrule; Sleeve for 0.5 mm<sup>2</sup> / 20 AWG; insulated; electro-tin plated; electrolytic copper; acc. to DIN 46228, Part 4/09.90; white

**Item No.: 216-241**

Ferrule; Sleeve for 0.5 mm<sup>2</sup> / 20 AWG; insulated; electro-tin plated; electrolytic copper; gastight crimped; acc. to DIN 46228, Part 4/09.90; white



**Item No.: 216-141**

Ferrule; Sleeve for 0.5 mm<sup>2</sup> / 20 AWG; un-insulated; electro-tin plated; electrolytic copper; gastight crimped; acc. to DIN 46228, Part 1/08.92

**Item No.: 216-101**

Ferrule; Sleeve for 0.5 mm<sup>2</sup> / AWG 22; un-insulated; electro-tin plated; silver-colored

**Item No.: 216-242**

Ferrule; Sleeve for 0.75 mm<sup>2</sup> / 18 AWG; insulated; electro-tin plated; electrolytic copper; gastight crimped; acc. to DIN 46228, Part 4/09.90; gray

**Item No.: 216-262**

Ferrule; Sleeve for 0.75 mm<sup>2</sup> / 18 AWG; insulated; electro-tin plated; electrolytic copper; gastight crimped; acc. to DIN 46228, Part 4/09.90; gray



**Item No.: 216-202**

Ferrule; Sleeve for 0.75 mm<sup>2</sup> / 18 AWG; insulated; electro-tin plated; gray

**Item No.: 216-142**

Ferrule; Sleeve for 0.75 mm<sup>2</sup> / 18 AWG; un-insulated; electro-tin plated; electrolytic copper; gastight crimped; acc. to DIN 46228, Part 1/08.92

**Item No.: 216-102**

Ferrule; Sleeve for 0.75 mm<sup>2</sup> / AWG 20; un-insulated; electro-tin plated; silver-colored

### 1.2.2 Strain relief

#### 1.2.2.1 Strain relief plate



**Item No.: 734-128**

Strain relief plate; for female and male connectors; 12.5 mm wide; 1 part; Pin spacing 3.5 mm; light gray

## 1.2.3 Tool

### 1.2.3.1 Operating tool



**Item No.: 734-190**

Combination operating tool; natural



**Item No.: 734-231**

Operating tool; black



**Item No.: 210-719**

Operating tool; Blade: 2.5 x 0.4 mm; with a partially insulated shaft



**Item No.: 210-647**

Operating tool; Blade: 2.5 x 0.4 mm; with a partially insulated shaft; multicoloured



**Item No.: 210-251**

Operating tool; for MCS MICRO and MINI with CAGE CLAMP® connection; yellow



**Item No.: 210-250**

Operating tool; for MCS MINI and MIDI with CAGE CLAMP® connection; red



**Item No.: 734-191**

Operating tool; made of insulating material; 1-way; loose; black



**Item No.: 734-230**

Operating tool; made of insulating material; 1-way; white

## Installation Notes

### Conductor termination

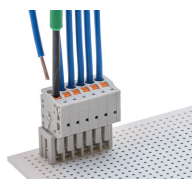

Conductor termination Inserting fine-stranded conductors into Push-in CAGE CLAMP® unit via push-buttons.

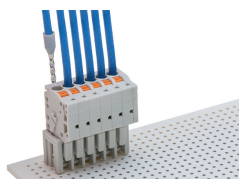

Push-in termination of solid conductors and fine-stranded conductors with ferrules

## Testing

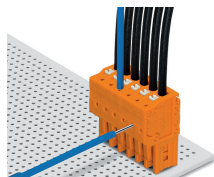

Testing via 1 mm Ø test pin (735-500). Push-in CAGE CLAMP® termination – parallel to conductor entry

## Marking

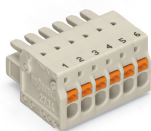

Labeling via direct marking or self-adhesive strips.

## Installation

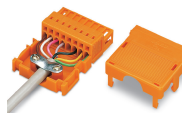

Strain relief housing for 734 Series Male and Female Connectors with CAGE CLAMP® connection

Subject to changes. Please also observe the further product documentation!

---

Current addresses can be found at: [www.wago.com](http://www.wago.com)