

Data Sheet | Item Number: 862-8633

4-conductor chassis-mount terminal strip; with ground contact; N-PE-L1; 3-pole; 1 snap-in foot per pole; 4 mm²; white

<https://www.wago.com/862-8633>



Color: ■ white

Similar to illustration

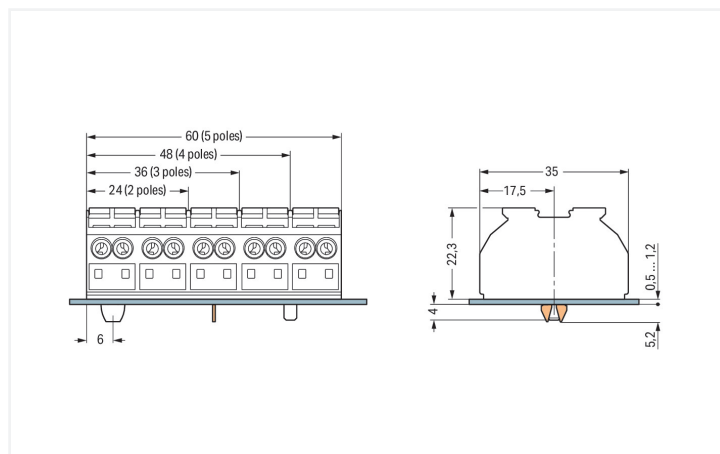

Dimensions in mm

Dimensions in mm for chassis-mount terminal strips



Dimensions in mm for PE contact and snap-in mounting foot (Ø 5.2 mm)

Chassis-mount terminal strip, 862 Series, with 12 mm pin spacing

Our chassis-mount terminal strip (item number 862-8633) ensures effortless electrical installations. Conductors should only be connected to this chassis-mount terminal strip if their strip length is between 10 and 11 mm. This product features conductor terminals and utilizes Push-in CAGE CLAMP®. Push-in CAGE CLAMP® technology provides a universal connection solution for all conductor types. It allows both solid and fine-stranded conductors with ferrules to be inserted directly into the clamping point without the need for tools. The item's dimensions are (36 x 27.5 x 35) mm (width x height x depth). This chassis-mount terminal strip is suitable for conductor cross sections ranging from 0.5 mm² to 4 mm².

Electrical data

Ratings per IEC/EN

Nominal voltage (III/3)	500 V
Rated impulse withstand voltage (III / 3)	6 kV
Rated current	32 A
Legend (ratings)	(III / 3) ≙ Overvoltage category III / Pollution degree 3

General information

Wiring direction	Side-entry wiring
------------------	-------------------

Connection Data

Clamping units	12
Total number of potentials	3
PE function	with ground contact

Connection 1

Connection technology	Push-in CAGE CLAMP®
Actuation type	Push-button
Connectable conductor materials	Copper
Solid conductor	0.5 ... 4 mm ² / 20 ... 12 AWG
Solid conductor; push-in termination	0.75 ... 4 mm ² / 18 ... 12 AWG
Stranded conductor	0.5 ... 4 mm ² / 20 ... 12 AWG
Fine-stranded conductor	0.5 ... 4 mm ² / 20 ... 12 AWG
Fine-stranded conductor; with insulated ferrule	0.5 ... 1.5 mm ² / 20 ... 16 AWG
Fine-stranded conductor; with ferrule; push-in termination	0.75 ... 1.5 mm ² / 18 ... 16 AWG
Note (conductor cross-section)	Depending on the conductor characteristic, a conductor with a smaller cross-section can also be inserted via push-in termination.
Strip length	10 ... 11 mm / 0.39 ... 0.43 inches
Pole number	3

Physical data

Pin spacing	12 mm / 0.472 inches
Width	36 mm / 1.417 inches
Height	27.5 mm / 1.083 inches
Height from the surface	22.3 mm / 0.878 inches
Depth	35 mm / 1.378 inches

Mechanical data

Marking	N-⊕-L1
Mounting type	Snap-in foot

Material data

Note (material data)	Information on material specifications can be found here
Color	white
Material group	I
Insulation material (main housing)	Polyamide (PA66)
Flammability class per UL94	V0
Fire load	0.401 MJ
Halogen-free	Yes
Weight	21.3 g

Commercial data

PU (SPU)	250 pcs
Packaging type	Bag
Country of origin	DE
GTIN	4044918510684
Customs tariff number	85369010000

Product Classification

UNSPSC	39121409
eCl@ss 10.0	27-14-11-06
eCl@ss 9.0	27-14-11-06
ETIM 9.0	EC001284
ETIM 10.0	EC001284
ECCN	NO US CLASSIFICATION

Environmental Product Compliance

RoHS Compliance Status	Compliant, No Exemption
------------------------	-------------------------

Approvals / Certificates

General approvals



Approval	Standard	Certificate Name
CCA DEKRA Certification B.V.	EN 60947	NTR NL 6912
CSA DEKRA Certification B.V.	C22.2 No. 158	1505030
ENEC 15 UL International Germany GmbH	EN 60998	143856-01
KEMA/KEUR DEKRA Certification B.V.	EN 60947	2146425.01
UL UL International Germany GmbH	UL 1059	E45172

Declarations of conformity and manufacturer's declarations

Approval	Standard	Certificate Name
EU-Declaration of Conformity WAGO GmbH & Co. KG	-	-
UK-Declaration of Conformity WAGO GmbH & Co. KG	-	-

Approvals for marine applications



Approval	Standard	Certificate Name
DNV GL Det Norske Veritas, Germanischer Lloyd	-	TAE00001V2
PRS Polski Rejestr Statków	-	TE/1094/880590/23

Downloads

Environmental Product Compliance

Compliance Search

Environmental Product Compliance 862-8633



Documentation

Bid Text			
862-8633	19.02.2019	xml 3.61 KB	↓
862-8633	12.06.2017	doc 24.50 KB	↓

CAD/CAE-Data

CAD data	
2D/3D Models 862-8633	↓







CAE data	
EPLAN Data Portal 862-8633	↓
WSCAD Universe 862-8633	↓
ZUKEN Portal 862-8633	↓

1 Compatible Products

1.1 Optional Accessories

1.1.1 Ferrule

1.1.1.1 Ferrule

 Item No.: 216-241 Ferrule; Sleeve for 0.5 mm ² / 20 AWG; insulated; electro-tin plated; electrolytic copper; gastight crimped; acc. to DIN 46228, Part 4/09.90; white	 Item No.: 216-141 Ferrule; Sleeve for 0.5 mm ² / 20 AWG; un-insulated; electro-tin plated; electrolytic copper; gastight crimped; acc. to DIN 46228, Part 1/08.92	 Item No.: 216-242 Ferrule; Sleeve for 0.75 mm ² / 18 AWG; insulated; electro-tin plated; electrolytic copper; gastight crimped; acc. to DIN 46228, Part 4/09.90; gray	 Item No.: 216-142 Ferrule; Sleeve for 0.75 mm ² / 18 AWG; un-insulated; electro-tin plated; electrolytic copper; gastight crimped; acc. to DIN 46228, Part 1/08.92
 Item No.: 216-243 Ferrule; Sleeve for 1 mm ² / AWG 18; insulated; electro-tin plated; electrolytic copper; gastight crimped; acc. to DIN 46228, Part 4/09.90; red	 Item No.: 216-143 Ferrule; Sleeve for 1 mm ² / AWG 18; un-insulated; electro-tin plated; electrolytic copper; gastight crimped; acc. to DIN 46228, Part 1/08.92	 Item No.: 216-244 Ferrule; Sleeve for 1.5 mm ² / AWG 16; insulated; electro-tin plated; electrolytic copper; gastight crimped; acc. to DIN 46228, Part 4/09.90; black	 Item No.: 216-144 Ferrule; Sleeve for 1.5 mm ² / AWG 16; un-insulated; electro-tin plated; electrolytic copper; gastight crimped; acc. to DIN 46228, Part 1/08.92; silver-colored

1.1.2 Jumper

1.1.2.1 Jumper



Item No.: 862-482 Jumper; for conductor entry; insulated; black

1.1.3 Marking

1.1.3.1 Marking strip



Item No.: 709-177

Marking strips; on reel; 7.5 mm wide; not stretchable; plain; snap-on type; translucent



Item No.: 709-178

Marking strips; on reel; 7.5 mm wide; not stretchable; plain; snap-on type; white

1.1.4 Test and measurement

1.1.4.1 Testing accessories



Item No.: 210-136

Test plug; 2 mm Ø; with 500 mm cable; red

1.1.5 Tool

1.1.5.1 Operating tool



Item No.: 210-720

Operating tool; Blade: 3.5 x 0.5 mm; with a partially insulated shaft; multicoloured

Installation Notes

**Cost-effective features:**

WAGO's 862 Series Chassis-Mount Terminal Strips were developed specifically to minimize wiring costs, while accommodating requirements for flexible mounting, multiple connection points and easy usage:

- Equipped with Push-in CAGE CLAMP®, the 862 Series connects up to four conductors sized 0.5 to 4 mm² (20 ... 12 AWG). Due to multiple connection points per pole, different conductor sizes can be used within the same terminal block position.
- For factory wiring, Push-in CAGE CLAMP® Connection Technology allows solid conductors, fine-stranded conductors with ferrules or ultrasonically bonded conductors from 0.5 ... 4 mm² (20 ... 12 AWG) to be terminated by simply pushing them into unit (length of bonded conductor end: min. 10 mm).
- Convenient automatic grounding contact (optional)
- Snap-in mounting feet for fast assembly
- Push-buttons for easy installation with an operating tool or by hand
- Built-in test points simplify testing with 2 mm Ø test plug
- Standard marking for each pole, or custom marking for large orders

Conductor termination

Terminating four conductors per pole – solid and fine-stranded.



Inserting a conductor via push-button.

Commoning

Commoning using a comb-style jumper bar (862-482).

Testing



Testing with a 2 mm Ø test plug (max. 42 V).



Dimensions in mm

Marking



Marking by direct, one-side printing and marking strips