

# Product data sheet

Specifications



Selector switch flush mounted,  
Harmony XB5, plastic, black, 30mm,  
3 positions, stay put, 2 NO

XB5FD33

## Main

Range of product	Harmony XB5
Product or component type	Selector switch
Device short name	XB5F
Bezel material	Dark grey plastic
Head type	Built-in-flush
Mounting diameter	30.5 mm
Sale per indivisible quantity	1
Shape of signaling unit head	Round
Type of operator	stay put
Operator profile	Black standard handle, unmarked
Operator position information	3 positions +/- 45°
Contacts type and composition	2 NO
Contact operation	Slow-break
Connections - terminals	Screw clamp terminals, $\leq 2 \times 1.5 \text{ mm}^2$ with cable end conforming to IEC 60947-1 Screw clamp terminals, $\geq 1 \times 0.22 \text{ mm}^2$ without cable end conforming to IEC 60947-1

## Complementary

Height	42 mm
Width	36.6 mm
Depth	73 mm
Terminals description ISO n°1	(13-14)NO (23-24)NO
Resistance to high pressure washer	7000000 Pa at 55 °C, distance : 0.1 m
Contacts usage	Standard contacts
Positive opening	Without
Mechanical durability	1000000 cycles
Tightening torque	0.8...1.2 N.m conforming to IEC 60947-1
Shape of screw head	Cross compatible with Philips no 1 screwdriver Cross compatible with pozidriv No 1 screwdriver Slotted compatible with flat $\varnothing 4 \text{ mm}$ screwdriver Slotted compatible with flat $\varnothing 5.5 \text{ mm}$ screwdriver
Contacts material	Silver alloy (Ag/Ni)
Short-circuit protection	10 A cartridge fuse type gG conforming to IEC 60947-5-1

<b>[Ith] conventional free air thermal current</b>	10 A conforming to IEC 60947-5-1
<b>[U<sub>i</sub>] rated insulation voltage</b>	600 V (pollution degree 3) conforming to IEC 60947-1
<b>[U<sub>imp</sub>] rated impulse withstand voltage</b>	6 kV conforming to IEC 60947-1
<b>[I<sub>e</sub>] rated operational current</b>	3 A at 240 V, AC-15, A600 conforming to IEC 60947-5-1 6 A at 120 V, AC-15, A600 conforming to IEC 60947-5-1 0.1 A at 600 V, DC-13, Q600 conforming to IEC 60947-5-1 0.27 A at 250 V, DC-13, Q600 conforming to IEC 60947-5-1 0.55 A at 125 V, DC-13, Q600 conforming to IEC 60947-5-1 1.2 A at 600 V, AC-15, A600 conforming to IEC 60947-5-1
<b>Electrical durability</b>	1000000 cycles, AC-15, 2 A at 230 V, operating rate <3600 cyc/h, load factor: 0.5 conforming to IEC 60947-5-1 appendix C 1000000 cycles, AC-15, 3 A at 120 V, operating rate <3600 cyc/h, load factor: 0.5 conforming to IEC 60947-5-1 appendix C 1000000 cycles, AC-15, 4 A at 24 V, operating rate <3600 cyc/h, load factor: 0.5 conforming to IEC 60947-5-1 appendix C 1000000 cycles, DC-13, 0.2 A at 110 V, operating rate <3600 cyc/h, load factor: 0.5 conforming to IEC 60947-5-1 appendix C 1000000 cycles, DC-13, 0.5 A at 24 V, operating rate <3600 cyc/h, load factor: 0.5 conforming to IEC 60947-5-1 appendix C
<b>Electrical reliability</b>	$\Lambda < 10\text{exp}(-6)$ at 5 V, 1 mA in clean environment conforming to IEC 60947-5-4 $\Lambda < 10\text{exp}(-8)$ at 17 V, 5 mA in clean environment conforming to IEC 60947-5-4
<b>Device presentation</b>	Complete product

## Environment

<b>Protective treatment</b>	TH
<b>Ambient air temperature for storage</b>	-40...70 °C
<b>Ambient air temperature for operation</b>	-40...70 °C
<b>Electrical shock protection class</b>	Class II conforming to IEC 60536
<b>IP degree of protection</b>	IP66 conforming to IEC 60529 IP67 IP69 IP69K
<b>Enclosure Type</b>	UL type 4X/13
<b>IK degree of protection</b>	IK03 conforming to IEC 50102
<b>Standards</b>	IEC 60947-1 UL 508 JIS C8201-5-1 IEC 60947-5-4 IEC 60947-5-1 CSA C22.2 No 14 JIS C8201-1 ISO 21702 ISO 22196:2011
<b>Product certifications</b>	UL listed CSA
<b>Vibration resistance</b>	5 gn (f= 2...500 Hz) conforming to IEC 60068-2-6
<b>Shock resistance</b>	30 gn (duration = 18 ms) for half sine wave acceleration conforming to IEC 60068-2-27 50 gn (duration = 11 ms) for half sine wave acceleration conforming to IEC 60068-2-27

## Packing Units

<b>Unit Type of Package 1</b>	PCE
<b>Number of Units in Package 1</b>	1
<b>Package 1 Height</b>	8.6 cm

Package 1 Width	4.3 cm
Package 1 Length	5.3 cm
Package 1 Weight	56 g
Unit Type of Package 2	S03
Number of Units in Package 2	120
Package 2 Height	30 cm
Package 2 Width	30 cm
Package 2 Length	40 cm
Package 2 Weight	7.793 kg

## Contractual warranty

Warranty (in months)	18
----------------------	----



## Environmental Data

Schneider Electric aims to achieve Net Zero status by 2050 through supply chain partnerships, lower impact materials, and circularity via our ongoing “Use Better, Use Longer, Use Again” campaign to extend product lifetimes and recyclability.

[Environmental Data explained >](#)

[How we assess product sustainability >](#)



### Environmental footprint

Total lifecycle Carbon footprint	0.7 kg CO2 eq.
Carbon footprint of the manufacturing phase [A1 to A3]	0.4 kg CO2 eq.
Carbon footprint of the distribution phase [A4]	0 kg CO2 eq.
Carbon footprint of the installation phase [A5]	0 kg CO2 eq.
Carbon footprint of the use phase [B2, B3, B4, B6]	0.2 kg CO2 eq.
Carbon footprint of the end-of-life phase [C1 to C4]	0.1 kg CO2 eq.

## Use Better



### Materials and Substances

Average percentage of recycled plastic content	27 %
Average percentage of recycled metal content	16 %
Packaging made with recycled cardboard	Yes
Packaging without single use plastic	Yes
EU RoHS Directive	<a href="#">Compliant</a>
REACH Regulation	<a href="#">Free of Substances of Very High Concern above the threshold</a>
California proposition 65	WARNING: This product can expose you to chemicals including: Di-isodecyl phthalate (DIDP), which is known to the State of California to cause birth defects or other reproductive harm. For more information go to <a href="http://www.P65Warnings.ca.gov">www.P65Warnings.ca.gov</a>

## Use Longer



### Lifetime extension

Repair	No
Product repair index	<a href="#">A</a>

## Use Again



### Repack and remanufacture

Recyclability potential, in %	23
End of life manual availability	<a href="#">End of Life Information</a>
Take-back	No
WEEE Label	 The product must be disposed on European Union markets following specific waste collection and never end up in rubbish bins

Dimensions Drawings

Dimensions

---

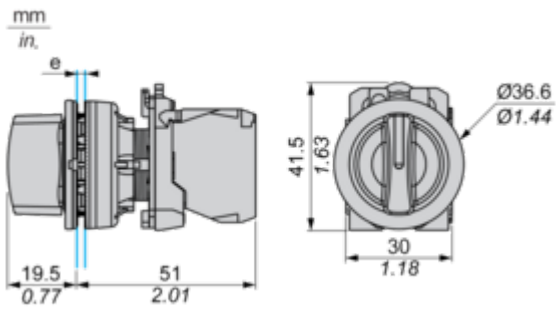

e: Clamping thickness: 1 to 6 mm / 0.04 to 0.24 in.

Mounting and Clearance

Panel Cut-out for Pushbuttons, Switches and Pilot Lights (Finished Holes, Ready for Installation)

---

Connection by Screw Clamp Terminals or Plug-in Connectors



(1) Diameter on finished panel or support

(2)  $\text{Ø}30.75 \text{ mm}$  recommended ( $\text{Ø}30.5 \text{ }_0^{+0.5}$ ) /  $\text{Ø}1.21 \text{ in.}$  recommended ( $\text{Ø}1.20 \text{ in. }_0^{+0.0196}$ )

Connections	a in mm	a in in.	b in mm	b in in.
By screw clamp terminals or plug-in connector	40	1.57	40	1.57
By Faston connectors	45	1.77	40	1.57

Technical Description

Electrical Composition Corresponding to Code C3

---



Electrical Composition Corresponding to Code C4

---



Electrical Composition Corresponding to Code C5

---

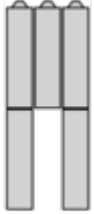

Electrical Composition Corresponding to Code C6

---

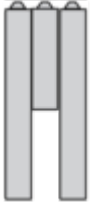

Electrical Composition Corresponding to Code C7

---

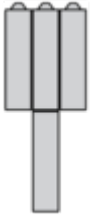

Electrical Composition Corresponding to Code C8

---

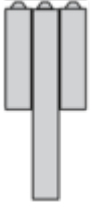

Electrical Composition Corresponding to Codes C9, C11, SF1 and SR1

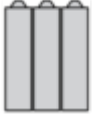

Electrical Composition Corresponding to Code C15

---

1 N/O

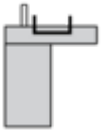

1 N/C



1 N/O + N/C or 1 N/O + N/O or 1 N/C + N/C



**Legend**

---

Single contact



Double contact



Light block



Possible location



Sequence of Contacts Fitted to 2-position Selector Switch Body

Position 315°



<b>Push</b>	Position	Top			
		Bottom			
	Location		Left	Centre	Right
	State		0	0	0
	<b>Contacts</b>	N/O		open	open
N/C		closed	closed	closed	

Position 45°



<b>Push</b>	Position	Top			
		Bottom			
	Location		Left	Centre	Right
	State		1	1	1
<b>Contacts</b>	N/O		closed	closed	closed
	N/C		open	open	open

Technical Illustration

Dimensions

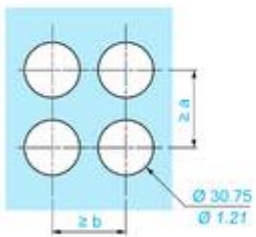
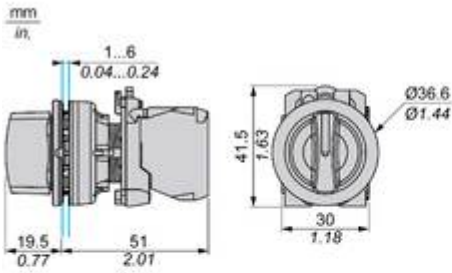







		a (mm)	a (in.)	b (mm)	b (in.)
		40	1.57	40	1.57
ZBE.....	ZBV.....				
		45	1.77	40	1.57
ZBE.....3	ZBV.....3				
		40	1.57	40	1.57
ZBE.....4	ZBV.....4				

Image of product / Alternate images

Alternative

---







Image of product in real life situation

