

Data Sheet | Item Number: 721-610/019-000

1-conductor male connector; CAGE CLAMP®; 2.5 mm²; Pin spacing 5 mm; 10-pole; 100% protected against mismatching; clamping collar; 2,50 mm²; light gray

<https://www.wago.com/721-610/019-000>

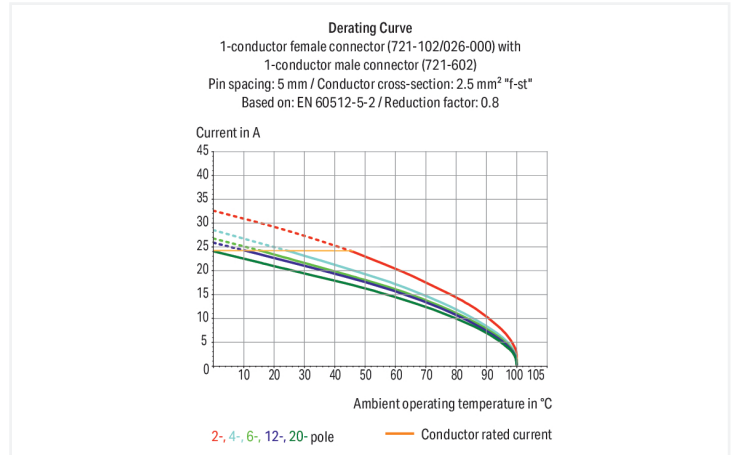

Color: ■ light gray

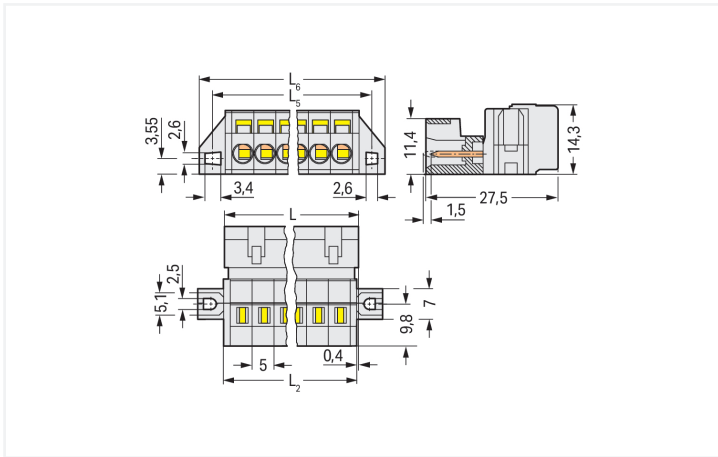

Dimensions in mm

$L = (\text{pole no.} - 1) \times \text{pin spacing} + 8.2 \text{ mm}$
 $L_2 = L - 0.2 \text{ mm}$
 $L_5 = L_2 + 5.8 \text{ mm}$
 $L_6 = L_2 + 11.8 \text{ mm}$

Male connector, 721 Series, 0° conductor exit to connection direction

Seamless electrical installations are guaranteed with this male connector (item number 721-610/019-000). Strip lengths must be between 8 and 9 mm when connecting conductors to this male connector. This product features one conductor terminal and utilizes CAGE CLAMP®. Our celebrated universal connection known as CAGE CLAMP® leads the way when it comes to connection technology and electrical interconnections. Dimensions: (64.8 x 14.3 x 27.5) mm (width x height x depth). Depending on the conductor type, this male connector is ideal for conductor cross sections ranging from 0.08 mm² to 2.5 mm².

Tin is used for coating the contact surfaces.

Notes

Safety Information

The MCS – MULTI CONNECTION SYSTEM includes connectors without breaking capacity in accordance with DIN EN 61984. When used as intended, these connectors must not be connected/disconnected when live or under load. When used as intended, these connectors must not be connected/disconnected when live or under load. The circuit design should ensure header pins, which can be touched, are not live when unmated.

Variants:

Other pole numbers
Gold-plated or partially gold-plated contact surfaces
Other versions (or variants) can be requested from WAGO Sales or configured at <https://configurator.wago.com/>.

Electrical data

Ratings per IEC/EN 60664-1				Approvals per UL 1059			
	III	III	II	Use group	B	C	D
Overvoltage category	III	III	II	Rated voltage	300 V	-	300 V
Pollution degree	3	2	2	Rated current	15 A	-	10 A
Nominal voltage	320 V	320 V	630 V				
Rated impulse withstand voltage	4 kV	4 kV	4 kV				
Rated current	12 A	12 A	12 A				

Approvals per UL 1977		Approvals per CSA			
	600 V	Use group	B	C	D
Rated voltage	600 V	Rated voltage	300 V	-	300 V
Rated current	15 A	Rated current	15 A	-	10 A

Connection Data

Clamping units	10	Connection 1	
Total number of potentials	10	Connection technology	CAGE CLAMP®
Number of connection types	1	Actuation type	Operating tool
Number of levels	1	Actuation direction 1	Operation parallel to conductor entry
		Actuation direction 2	Operation perpendicular to conductor entry
		Solid conductor	0.08 ... 2.5 mm ² / 28 ... 12 AWG
		Fine-stranded conductor	0.08 ... 2.5 mm ² / 28 ... 12 AWG
		Fine-stranded conductor; with insulated ferrule	0.25 ... 1.5 mm ²
		Fine-stranded conductor; with uninsulated ferrule	0.25 ... 2.5 mm ²
		Strip length	8 ... 9 mm / 0.31 ... 0.35 inches
		Pole number	10
		Conductor entry direction to mating direction	0°

Physical data

Pin spacing	5 mm / 0.197 inches
Width	64.8 mm / 2.551 inches
Height	14.3 mm / 0.563 inches
Depth	27.5 mm / 1.083 inches

Mechanical data

Variable coding	Yes
Direct ground contact to DIN-rail/drilled hole/housing	No
Mounting type	Mounting flange
Mounting type	Feed-through mounting Panel mounting
Anti-rotation protection	Yes
Suitable for through-panel applications	Yes

Plug-in connection

Contact type (pluggable connector)	Male connector/plug
Connector (connection type)	for conductor
Mismating protection	Yes

Material data

Note (material data)	Information on material specifications can be found here
Color	light gray
Material group	I
Insulation material (main housing)	Polyamide (PA66)
Flammability class per UL94	V0
Clamping spring material	Chrome-nickel spring steel (CrNi)
Contact material	Electrolytic copper (E _{Cu})
Contact Plating	Tin
Fire load	0.294 MJ
Weight	16.3 g

Environmental requirements

Limit temperature range	-60 ... +100 °C
Processing temperature	-35 ... +60 °C

Environmental Testing

Test specification: Railway applications – Rolling stock – Electronic equipment	DIN EN 50155 (VDE 0115-200):2022-06
Test procedure: Railway applications – Rolling stock equipment – Vibration and shock tests	DIN EN 61373 (VDE 0115-0106):2011-04
Spectrum/Mounting location	Service life test, Category 1, Class A/B
Functional test with noise-like oscillations	Test passed according to Section 8 of the standard
Frequency	f ₁ = 5 Hz to f ₂ = 150 Hz
Acceleration	0.101g (highest test level used for all axes)
Test duration per axis	10 min.
Test directions	X, Y and Z axes
Monitoring of contact faults and interruptions	Passed
Voltage drop measurement before and after each axis	Passed
Simulated service life test through increased levels of noise-like oscillations	Test passed according to Section 9 of the standard
Frequency	f ₁ = 5 Hz to f ₂ = 150 Hz
Acceleration	0.572g (highest test level used for all axes)
Test duration per axis	5 h
Test directions	X, Y and Z axes
Extended testing: Monitoring of contact faults and interruptions	Passed

Environmental Testing	
Extended testing: Voltage drop measurement before and after each axis	Passed
Shock test	Test passed according to Section 10 of the standard
Shock pulse form	Half sine
Acceleration	5g (highest test level used for all axes)
Shock duration	30 ms
Number of shocks (per axis)	3 pos. und 3 neg.
Test directions	X, Y and Z axes
Extended testing: Monitoring of contact faults and interruptions	Passed
Extended testing: Voltage drop measurement before and after each axis	Passed
Vibration and shock stress for rolling stock equipment	Passed

Commercial data	
Product Group	3 (Multi Conn. System)
PU (SPU)	25 pcs
Packaging type	Box
Country of origin	DE
GTIN	4044918264129
Customs tariff number	85366930000

Product Classification	
UNSPSC	39121409
eCl@ss 10.0	27-44-03-09
eCl@ss 9.0	27-44-03-09
ETIM 9.0	EC002638
ETIM 10.0	EC002638
ECCN	NO US CLASSIFICATION

Environmental Product Compliance	
RoHS Compliance Status	Compliant, No Exemption

Approvals / Certificates

General approvals		
Approval	Standard	Certificate Name
CB DEKRA Certification B.V.	IEC 61984	NL-113351
CSA DEKRA Certification B.V.	C22.2	1466354
KEMA/KEUR DEKRA Certification B.V.	EN 61984	71-130478 REV.1
UL Underwriters Laboratories Inc.	UL 1059	E45172
UR Underwriters Laboratories Inc.	UL 1977	E45171

Declarations of conformity and manufacturer's declarations		
Approval	Standard	Certificate Name
Railway WAGO GmbH & Co. KG	-	Railway Ready

Approvals for marine applications



Approval	Standard	Certificate Name
ABS American Bureau of Ship- ping	-	24-0095975-PDA
DNV DNV GL SE	-	TAE000016Z
PRS Polski Rejestr Statków	-	TE/1095/880590/23

Downloads

Environmental Product Compliance

Compliance Search	
Environmental Product Compliance 721-610/019-000	↓

Documentation

Additional Information			
Technical Section	03.04.2019	pdf 2027.26 KB	↓

CAD/CAE-Data

CAD data	
2D/3D Models 721-610/019-000	↓

CAE data	
EPLAN Data Portal 721-610/019-000	↓
ZUKEN Portal 721-610/019-000	↓

1 Compatible Products

1.1 System counterpart

1.1.1 Female connector/socket



Item No.: 721-110/026-000
1-conductor female connector; CAGE CLAMP®; 2.5 mm²; Pin spacing 5 mm; 10-pole; 100% protected against mismatching; 2,50 mm²; light gray



Item No.: 722-240
THT female header; angled; Pin spacing 5 mm; 10-pole; 100% protected against mismatching; 0.6 x 1.0 mm solder pin; light gray



Item No.: 722-140
THT female header; straight; Pin spacing 5 mm; 10-pole; 100% protected against mismatching; 0.6 x 1.0 mm solder pin; light gray

1.2 Optional Accessories

1.2.1 Coding

1.2.1.1 Coding



Item No.: 231-129

Coding key; snap-on type; light gray

1.2.2 Cover

1.2.2.1 Cover



Item No.: 231-668

Lockout caps; for covering unused clamping units; gray

1.2.3 Ferrule

1.2.3.1 Ferrule



Item No.: 216-301

Ferrule; Sleeve for 0.25 mm² / AWG 24; insulated; electro-tin plated; yellow



Item No.: 216-302

Ferrule; Sleeve for 0.34 mm² / 22 AWG; insulated; electro-tin plated; light turquoise



Item No.: 216-201

Ferrule; Sleeve for 0.5 mm² / 20 AWG; insulated; electro-tin plated; electrolytic copper; acc. to DIN 46228, Part 4/09.90; white



Item No.: 216-241

Ferrule; Sleeve for 0.5 mm² / 20 AWG; insulated; electro-tin plated; electrolytic copper; gastight crimped; acc. to DIN 46228, Part 4/09.90; white



Item No.: 216-141

Ferrule; Sleeve for 0.5 mm² / 20 AWG; un-insulated; electro-tin plated; electrolytic copper; gastight crimped; acc. to DIN 46228, Part 1/08.92



Item No.: 216-101

Ferrule; Sleeve for 0.5 mm² / AWG 22; un-insulated; electro-tin plated; silver-colored



Item No.: 216-242

Ferrule; Sleeve for 0.75 mm² / 18 AWG; insulated; electro-tin plated; electrolytic copper; gastight crimped; acc. to DIN 46228, Part 4/09.90; gray



Item No.: 216-262

Ferrule; Sleeve for 0.75 mm² / 18 AWG; insulated; electro-tin plated; electrolytic copper; gastight crimped; acc. to DIN 46228, Part 4/09.90; gray



Item No.: 216-202

Ferrule; Sleeve for 0.75 mm² / 18 AWG; insulated; electro-tin plated; gray



Item No.: 216-142

Ferrule; Sleeve for 0.75 mm² / 18 AWG; un-insulated; electro-tin plated; electrolytic copper; gastight crimped; acc. to DIN 46228, Part 1/08.92



Item No.: 216-102

Ferrule; Sleeve for 0.75 mm² / AWG 20; un-insulated; electro-tin plated; silver-colored



Item No.: 216-243

Ferrule; Sleeve for 1 mm² / AWG 18; insulated; electro-tin plated; electrolytic copper; gastight crimped; acc. to DIN 46228, Part 4/09.90; red



Item No.: 216-263

Ferrule; Sleeve for 1 mm² / AWG 18; insulated; electro-tin plated; electrolytic copper; gastight crimped; acc. to DIN 46228, Part 4/09.90; red



Item No.: 216-203

Ferrule; Sleeve for 1 mm² / AWG 18; insulated; electro-tin plated; red



Item No.: 216-103

Ferrule; Sleeve for 1 mm² / AWG 18; un-insulated; electro-tin plated



Item No.: 216-143

Ferrule; Sleeve for 1 mm² / AWG 18; un-insulated; electro-tin plated; electrolytic copper; gastight crimped; acc. to DIN 46228, Part 1/08.92



Item No.: 216-204

Ferrule; Sleeve for 1.5 mm² / AWG 16; insulated; electro-tin plated; black



Item No.: 216-244

Ferrule; Sleeve for 1.5 mm² / AWG 16; insulated; electro-tin plated; electrolytic copper; gastight crimped; acc. to DIN 46228, Part 4/09.90; black



Item No.: 216-264

Ferrule; Sleeve for 1.5 mm² / AWG 16; insulated; electro-tin plated; electrolytic copper; gastight crimped; acc. to DIN 46228, Part 4/09.90; black



Item No.: 216-244

Ferrule; Sleeve for 1.5 mm² / AWG 16; insulated; electro-tin plated; electrolytic copper; gastight crimped; acc. to DIN 46228, Part 4/09.90; black



Item No.: 216-144

Ferrule; Sleeve for 1.5 mm² / AWG 16; un-insulated; electro-tin plated; electrolytic copper; gastight crimped; acc. to DIN 46228, Part 1/08.92; silver-colored



Item No.: 216-104

Ferrule; Sleeve for 1.5 mm² / AWG 16; un-insulated; electro-tin plated; silver-colored



Item No.: 216-106

Ferrule; Sleeve for 2.5 mm² / AWG 14; un-insulated; electro-tin plated; silver-colored

1.2.4 Installation

1.2.4.1 Mounting accessories



Item No.: 231-295
Screw with nut



Item No.: 231-195
Screw with nut; M2x12; for fixing element



Item No.: 209-147
Self-tapping screw



Item No.: 231-194
Self-tapping screw; B 2.2x13, fixing hole 1.8 mm Ø

1.2.5 Insulation stop

1.2.5.1 Insulation stop



Item No.: 231-670
Insulation stop; 0.08-0.2 mm² / 0.2 mm² "s"; white



Item No.: 231-671
Insulation stop; 0.25 - 0.5 mm²; light gray



Item No.: 231-672
Insulation stop; 0.75 - 1 mm²; dark gray

1.2.6 Jumper

1.2.6.1 Jumper



Item No.: 231-910
Jumper; for conductor entry; 10-way; insulated; gray



Item No.: 231-902
Jumper; for conductor entry; 2-way; insulated; gray



Item No.: 231-903
Jumper; for conductor entry; 3-way; insulated; gray



Item No.: 231-905
Jumper; for conductor entry; 5-way; insulated; gray



Item No.: 231-907
Jumper; for conductor entry; 7-way; insulated; gray

1.2.7 Marking

1.2.7.1 Marking strip



Item No.: 210-331/500-103
Marking strips; as a DIN A4 sheet; MARKED; 1-12 (300x); Height of marker strip: 2.3 mm/0.091 in; Strip length 182 mm; Horizontal marking; Self-adhesive; white



Item No.: 210-332/500-202
Marking strips; as a DIN A4 sheet; MARKED; 1-16 (160x); Height of marker strip: 3 mm; Strip length 182 mm; Horizontal marking; Self-adhesive; white



Item No.: 210-332/500-205
Marking strips; as a DIN A4 sheet; MARKED; 1-32 (80x); Height of marker strip: 3 mm; Strip length 182 mm; Horizontal marking; Self-adhesive; white



Item No.: 210-331/500-104
Marking strips; as a DIN A4 sheet; MARKED; 13-24 (300x); Height of marker strip: 2.3 mm/0.091 in; Strip length 182 mm; Horizontal marking; Self-adhesive; white



Item No.: 210-332/500-204
Marking strips; as a DIN A4 sheet; MARKED; 17-32 (160x); Height of marker strip: 3 mm; Strip length 182 mm; Horizontal marking; Self-adhesive; white



Item No.: 210-332/500-206
Marking strips; as a DIN A4 sheet; MARKED; 33-48 (160x); Height of marker strip: 3 mm; Strip length 182 mm; Horizontal marking; Self-adhesive; white

1.2.8 Strain relief

1.2.8.1 Strain relief housing



Item No.: 232-610

Strain relief housing; for female and male connectors; 2 parts; Pin spacing 5 mm; 10-pole; gray

1.2.9 Tool

1.2.9.1 Operating tool



Item No.: 231-231

Combination operating tool; red



Item No.: 210-720

Operating tool; Blade: 3.5 x 0.5 mm; with a partially insulated shaft; multicoloured



Item No.: 210-657

Operating tool; Blade: 3.5 x 0.5 mm; with a partially insulated shaft; short; multicoloured



Item No.: 280-440

Operating tool; made of insulating material; 10-way; white



Item No.: 209-130

Operating tool; made of insulating material; 1-way; for 264 Series (1-/2-way), 280, 281 Series (up to 3-way); natural



Item No.: 231-291

Operating tool; made of insulating material; 1-way; loose; red



Item No.: 231-131

Operating tool; made of insulating material; 1-way; loose; white



Item No.: 280-432

Operating tool; made of insulating material; 2-way; white



Item No.: 280-433

Operating tool; made of insulating material; 3-way; white



Item No.: 280-434

Operating tool; made of insulating material; 4-way; white



Item No.: 280-435

Operating tool; made of insulating material; 5-way; gray



Item No.: 280-436

Operating tool; made of insulating material; 6-way; white



Item No.: 280-437

Operating tool; made of insulating material; 7-way; white



Item No.: 280-438

Operating tool; made of insulating material; 8-way; white



Item No.: 231-159

Operating tool; natural

Installation Notes

Conductor termination

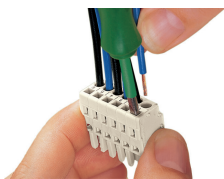

Inserting a conductor via 3.5 mm screwdriver – CAGE CLAMP® actuation parallel to conductor entry.

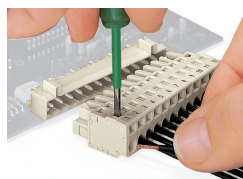

Inserting a conductor via 3.5 mm screwdriver – CAGE CLAMP® actuation perpendicular to conductor entry.

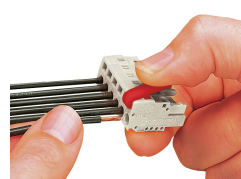

Inserting a conductor via operating tool.

Testing

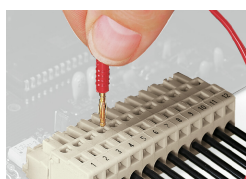

Testing perpendicular to conductor entry with 2 or 2.3 mm Ø test plug – female connector with CAGE CLAMP® – via integrated test ports

Installation



Male connector with strain relief plate

Strain relief housing shown with a male connector equipped with CAGE CLAMP®

Coding

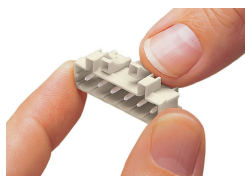

Coding a male header – fitting coding key (s).