

Mounting system for solar panels on metal sheet roofing

CONTENTS

	page
1. Introduction	1
2. General installation conditions	1
3. Product description	3
4. Parts overview	3
4.1 Exploded view mounting system in landscape orientation	3
4.2 Exploded view mounting system in portrait orientation	4
4.3 Parts list mounting system in landscape orientation	5
4.4 Parts list mounting system in portrait orientation	5
5. Mounting preparations	6
5.1 Tools and accessories check	6
5.2 Cleaning the roof	6
5.3 Determining and measuring position of solar panels	7
6. Installation mounting system in landscape orientation	8
6.1 Positioning the mounting profiles	8
6.2 Attaching the mounting profiles with screws	9
6.3 Attaching the mounting profiles with blind rivets	10
6.4 Mounting Clickfit EVO MLPE clip Light or Heavy Weight (option)	11
6.5 Installation of 1st solar panel on mounting profiles	12
6.6 Installation of other solar panels on the mounting profiles	13
6.7 Final assembly / multiple rows	14
7. Installation mounting system in portrait orientation	15
7.1 Positioning the mounting profiles	15
7.2 Attaching the mounting profiles with screws	16
7.3 Attaching the mounting profiles with blind rivets	17
7.4 Mounting Clickfit EVO MLPE clip Light or Heavy Weight (option)	18
7.5 Installation of 1st solar panel on mounting profiles	19
7.6 Installation of other solar panels on the mounting profiles	20
7.7 Final assembly 1st row of adjacent solar panels	21
7.8 Final assembly / multiple rows below each other	22
8. Attachments	23
8.1 Application matrix	23
8.2 Installation of the corrugated adapter profile for landscape installations	25

THIS INSTALLATION MANUAL SHOULD BE KEPT FOR FUTURE USE!

For the warranty period and terms, we recommend you contact your supplier. In addition, we would like to refer to our General Terms of Sale and Delivery, which can be found on the website www.esdec.com.

The manufacturer cannot be held liable for damage or injury resulting from a failure to comply with this mounting manual and a lack of general carefulness during transport, assembly and use of the mounting system. As a result of our constant desire to improve, it is possible that the product differs from what is described in this manual in certain details. For this reason, the instructions only serve as an installation guideline for the product described in this manual. This manual was compiled with the utmost care, but the manufacturer cannot be held liable for any mistakes in this manual or the results of these.

In addition, all rights are reserved and nothing in this manual can, in any way, be copied.

1. Introduction

This manual covers the installation of our mounting system for metal sheet roofing (for solar panels in landscape and portrait orientation).

Carefully read the manual, so you are fully familiar with its contents. Carefully follow the instructions in the manual. Always perform actions in the right order.

Keep the manual in a safe and dry place. If the manual is lost, a new copy can be downloaded from www.esdec.com.

2. General installation conditions

General

A failure to comply with the regulations stated in this document may cause all warranty and product liability claims to become void.

The information, comments, and recommendations in this document are legally binding and users should check if they are complete and up to date. Esdec BV reserves the right to adjust this document without prior notice.

Stability and condition of the roof

The roof should be in good condition and should have sufficient strength to bear the weight of the solar panels including any additional materials, wind, and snow load. Check the stability of the roof and adjust the roof/construction if necessary. Always consult a contractor in case of doubt. Make sure the reserve load capacity of the roof is not exceeded anywhere.

Safety warnings

- The assembly of the mounting system should be performed by qualified technical personnel (at least 2 skilled people).
- Adding or omitting parts can negatively impact the functionality and is strongly discouraged!
- Before placing the solar panels, the roof should be dry, clean, level and free of algae etc.
- Avoid assembly with strong winds or a slippery roof surface.
- On a sloping roof, always work with fall protection and, if necessary, with safety nets and edge protection.
- **Note!** Never stand in the gutter.
- Never walk on the system or on the solar panels.
- Wear shoes with reinforced toecaps and strong anti-slip soles.
- Always wear the appropriate protective clothing when performing work.
- Always use a lifting aid/lift installation when moving materials (solar panels etc.).
- Always place ladders on a sturdy, stable surface.
- Always place the ladder at an angle of about 75° and make sure it extends about 1 metre above the edge of the roof.
- If possible, secure the ladder at the top using a rope or lashing strap.
- Preferably comply with the manual “working safely on rooftops”.

Scope of application

- Panel dimensions: maximum solar panel size of 3.92 m².
 - The universal module clamp is suitable for solar panels with a frame thickness between 30 - 50 mm and a frame width of at least 12 mm, where a sufficient clamping force can be achieved. Thanks to its smart design, the ClickFit Evo universal clamp can be used as a middle clamp and as an end clamp (in combination with the end cap). Check whether the chosen solar panel can withstand the loads and clamping force, in the documentation of the solar panel supplier.
 - Maximum roof height: dependent on Eurocode guidelines and national additions. Use the calculator to calculate the possibilities for your project.
 - Applicable windloads can be checked in the application matrix (chapter 8.1) and/or Esdec calculator at www.esdec.com
 - Roofing type: Metal sheet roofing.
 - Roof slope: Between 2 and 60 degrees. Improper installation of solar panels at a low inclination angle can reduce the self-cleaning capacity of the system; carefully follow the panel manufacturer's instructions.
 - Use the calculator to ensure you select the right mounting system for the terrain category, snow load and wind zone applicable to your project.
- Note!** To prevent galvanic corrosion do not apply aluminium rivets at stainless steel roofing material.

No installation zone

The distance in between solar modules and roof edge should be at least 30cm due to unpredictable windloads. Edge zones according Eurocode will be calculated by the Esdec calculator. (www.esdec.com)

Standards, regulations and rules

During the installation of the mounting system, it is important to adhere to the installation manual and the accompanying standards to prevent accidents. Pay special attention to (local) standards, regulations and legislation (among others):

- The Building Regulations 2010 (latest version)
- Health and Safety at Work etc Act 1974
- Health and Safety in Roof work - HSE
- Eurocodes 0 (EN 1990 - Structural Design)
- Eurocodes 1 (EN 1991 - (Influences on structures)
- HD-IEC 60363 series - Electrical installations for low voltage
- EN-IEC 62305-2 - Protection lightning - Risk Management
- MIS 3002 – The solar PV standard
- MCS012 - Product Certification Scheme Requirements: Pitched Roof Installation Kits

Removal and dismantling

Dispose of the product in compliance with local laws and regulations.

Earthing and bonding

Our ClickFit EVO systems are VDE certified for corrosion and bonding. According to the electrical standard HD-IEC 60364 – chapter 712, functional bonding for inverter's isolation check is necessary.

In the Esdec ClickFit EVO Series functional bonding is achieved through the EVO universal module clamp for the module frames and EVO rails. The final functional bonding connection is made by proper mounting of a separate bonding cable onto the EVO rail and an adequate bonding connection with the inverter or earthing contact.

For detailed instructions on grounding and bonding, consult the electrical standard HD-IEC 60364 and any local regulations. Please, follow the instructions of the inverter's manual. This operation needs to be done by a certified electrician.

Warranty

Warranty according to the terms of warranty and the terms and conditions of Esdec BV. These can be found on the website www.esdec.com.

Liability

The manufacturer shall not be held liable for any damage or injury caused by a failure to (strictly) comply with the safety regulations and instructions in this manual or due to carelessness during the installation of the product described in this document and any accessories.

- printing errors reserved

3. Product description

The mounting system is made of mounting profiles and the required mounting materials to mount the solar panels in landscape or portrait orientation on the metal sheet roof.

The mounting system for metal sheet roofing can be used for all metal sheet roofs, including the common corrugated or trapezoidal metal sheet roofs. (The metal sheet thickness should be minimal 0,5mm)

Roof attachment

The mounting profiles are attached to the metal sheet using self-tapping screws or blind rivets. **Note!** There are two options: a high (Optimizer ready) or low (Basic) mounting profile. In this manual, the high mounting profile is shown by default.

The height of the mounting profile does not have any consequences for the required parts, with the exception of the optional MLPE Light Weight and MLPE Heavy Weight clip and optimizer. These can only be used for the high mounting profile. The high mounting profiles have a notch that functions as a point of reference when aligning the profiles.

Because the mounting profiles are not attached to the rafters or purlins, the position of the solar panels on the roof can be selected freely.

The mounting profiles have EPDM sealing tape at the bottom, which serves as a water barrier. In case of corrugated roofs, the mounting profiles are provided with an optional EPDM adapter profile.

Fastening the MLPE Light and Heavy Weight clips

The MLPE Light and MLPE Heavy Weight clip is fastened to the mounting profiles by means of a click connection.

Attachment of the panels

The solar panels are attached to the mounting profiles using universal module clamps.

4. Parts overview

4.1 Exploded view mounting system in landscape orientation

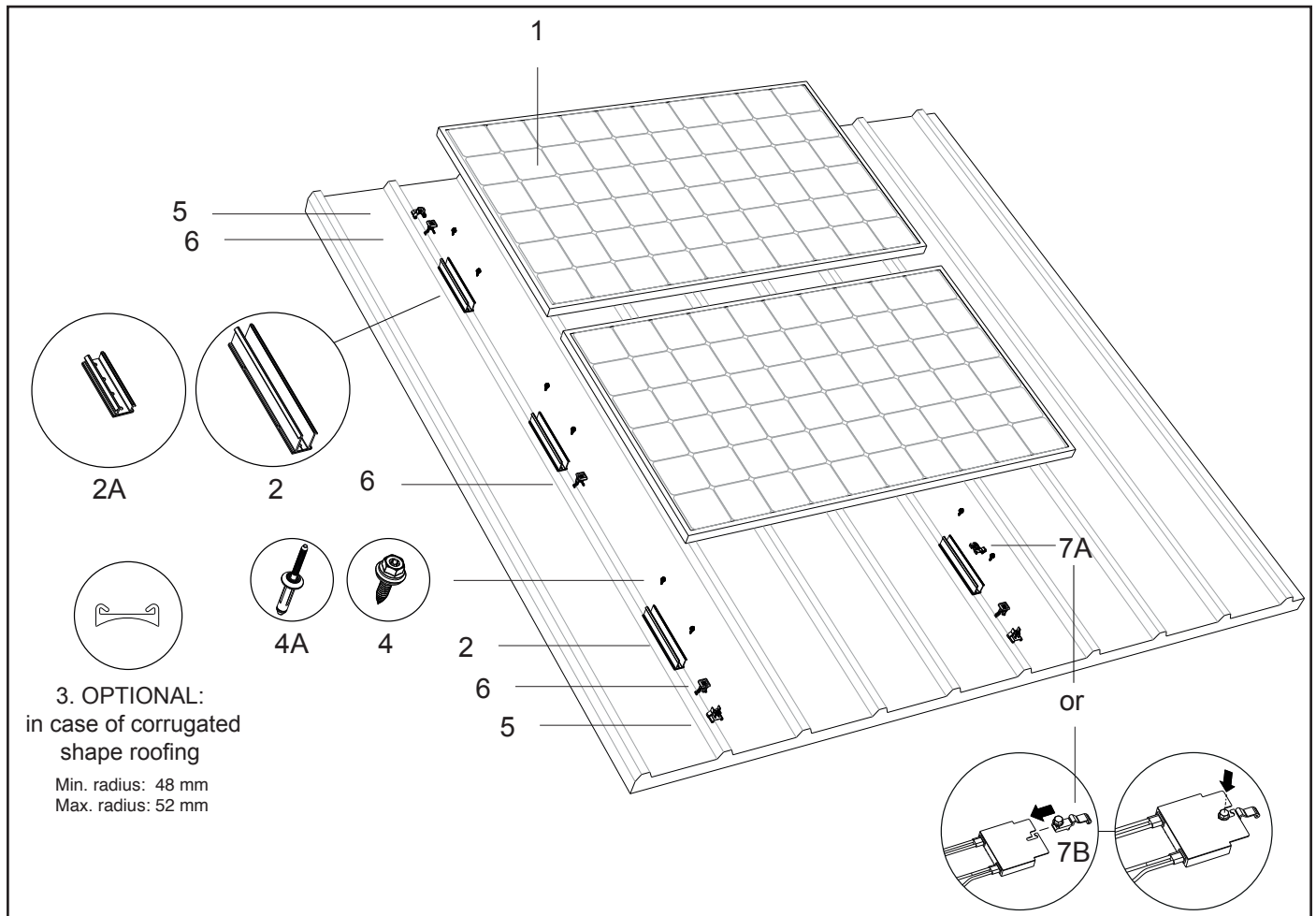

4.2 Exploded view mounting system in portrait orientation

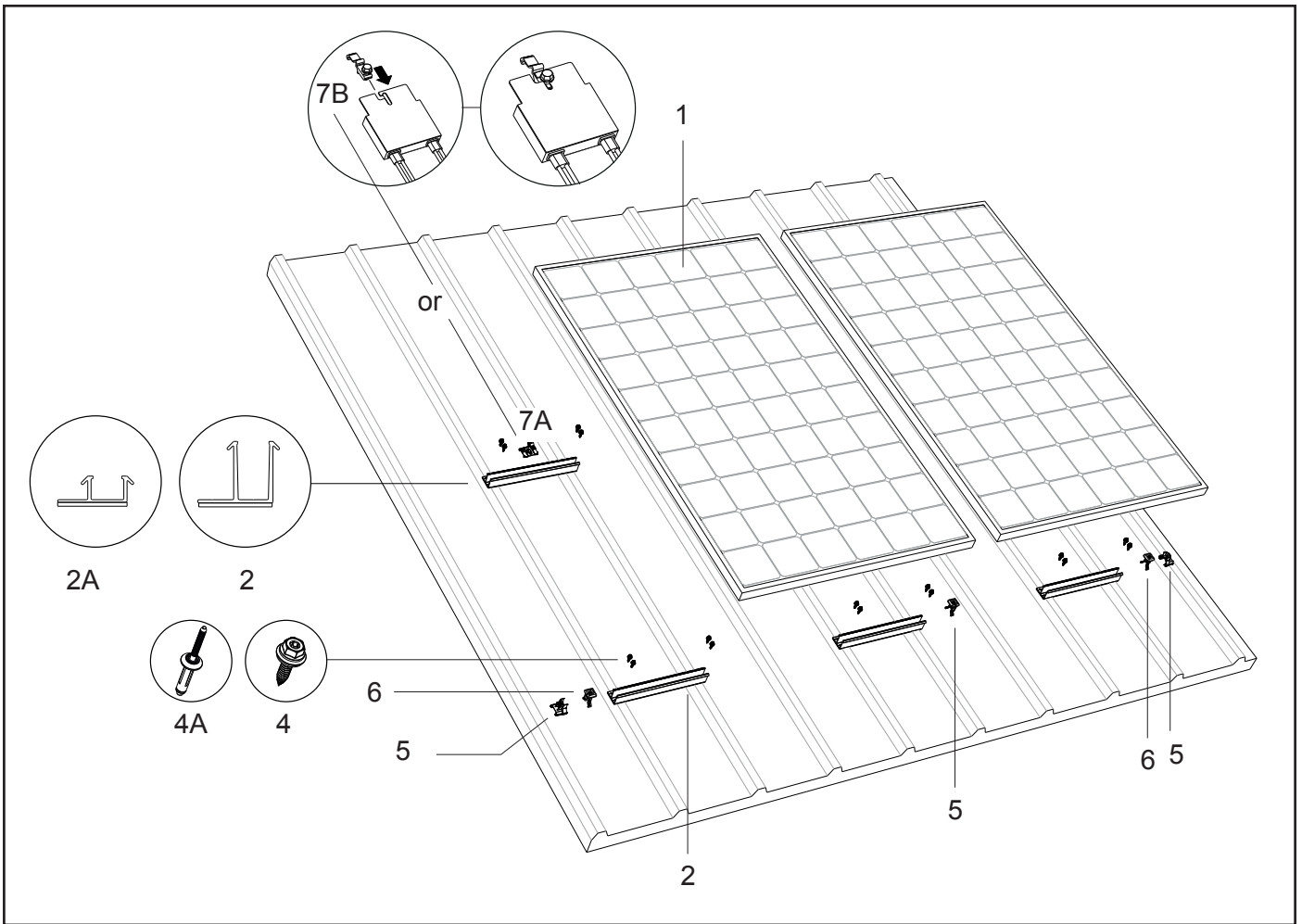

4.3 Parts list mounting system in landscape orientation

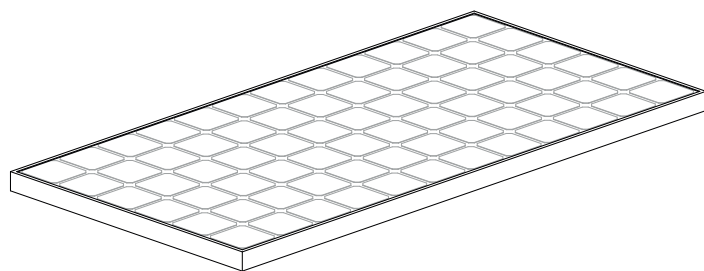

1. Solar panel

2. Mounting profile metal sheet roof 'Optimizer ready' landscape
Product no.: 1008050

2A. Mounting profile metal sheet roof 'Basic' landscape
Product no.: 1008048

3. EPDM adapter profile corrugated metal sheet roof 'Optimizer ready' landscape
Product no.: 1008082
*optional

3A. EPDM adapter profile corrugated metal sheet roof 'Basic' landscape
Product no.: 1008081
*optional



4. Self-tapping screw 6.0x25 mm
SW10 HEX/T30
Product no.: 1008085



4A. ClickFit EVO Magnatite Rivet
Product no.: 1008087



5. End clamp support grey
Product no.: 1008065

5B. End clamp support black
Product no.: 1008065-B



6. Module Clamp Universal grey
Product no.: 1008020

6B. Module Clamp Universal black
Product no.: 1008020-B



7A. ClickFit EVO MLPE Clip Light Weight
Product no.: 1008067



7B. ClickFit EVO MLPE Clip Heavy Weight
Product no.: 1008068

4.4 Parts list mounting system in portrait orientation

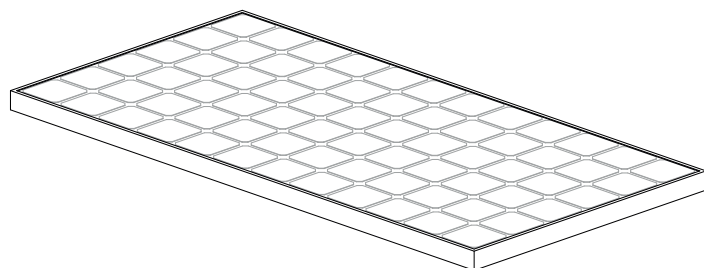

1. Solar panel

2. Mounting profile metal sheet roof 'Optimizer ready' portrait
Product no.: 1008051

2A. Mounting profile metal sheet roof 'Basic' portrait
Product no.: 1008049



4. Self-tapping screw 6.0x25 mm
SW10 HEX/T30
Product no.: 1008085



4A. ClickFit EVO Magnatite Rivet
Product no.: 1008087



5. End clamp support grey
Product no.: 1008065

5B. End clamp support black
Product no.: 1008065-B



6. Module Clamp Universal grey
Product no.: 1008020

6B. Module Clamp Universal black
Product no.: 1008020-B



7A. ClickFit EVO MLPE Clip Light Weight
Product no.: 1008067



7B. ClickFit EVO MLPE Clip Heavy Weight
Product no.: 1008068

5. Mounting preparations

5.1 Tools and accessories check

The following is a list of the required tools / aids:

Marker / crayon

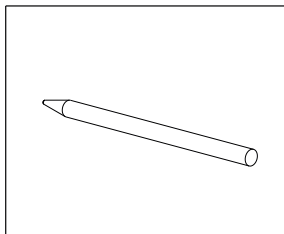

Brush

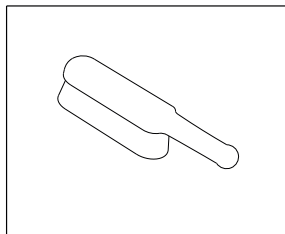

Tape measure

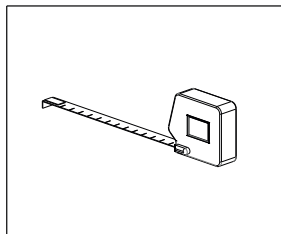

Battery drill (incl. T30 & diameter 6,5mm HSS)

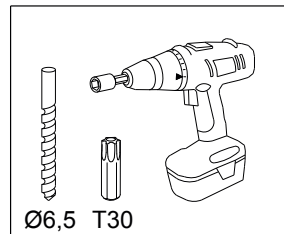

Rivet pliers with correct nose piece

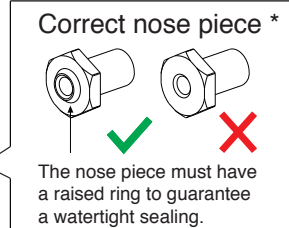
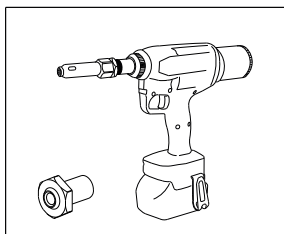

* Any questions about the correct nose piece? Please contact Esdec.

Hexagon socket ratchet

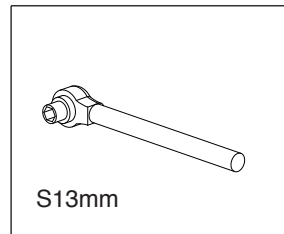

Water pump pliers

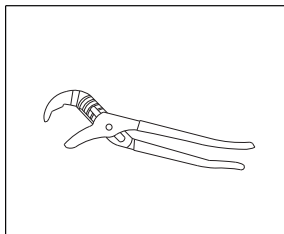

Safety shoes

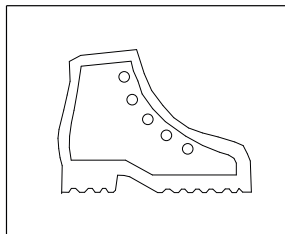

Safety helmet

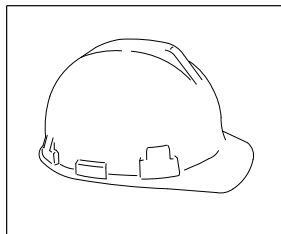

Safety clothing

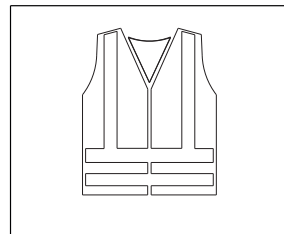

Safety gloves

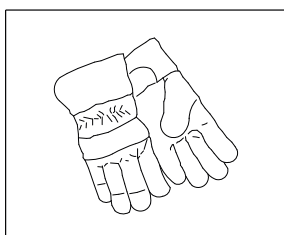

5.2 Cleaning the roof

Clean the metal sheet roof with a brush.

Remove algae, moss etc. to reduce unevenness during the installation to a minimum!

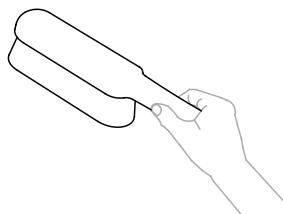

5.3 Determining and measuring position of solar panels

Take into account the (local) fire regulations for photovoltaic installations. To reduce the risk of fire spread, the fire compartments of the object must be respected. The PV system must not be installed over fire partitions and a minimum distance of 30 cm must be maintained. It is also wise to keep space in relation to skylights, orbs, corners and possible fire hazards.

When determining the position of the solar panels on the sloped roof, it is very important to pay attention to the position of the sun during the day and the entire year. Place the panels on a roof surface that has a minimum amount of shade. Shade from a chimney, dormer, tree or adjacent building negatively impacts the yield of the solar panels. We strongly recommend using the optimizer here.

Measuring and demarcating

In order to place the solar panel (in landscape or portrait orientation) you need a space of at least the outside dimensions of the module of about 160x80 cm or 160x100cm or 200x100cm per panel. (depending on the type of solar panel) Make sure there is a space of at least 30 cm around the solar panels on the roof. This means 30 cm away from the ridge and gutter and 30 cm away from the sides because of turbulent wind load. Mark the contours of the panels and the field on the steel sheets with a marker or crayon.

Demarcation for landscape orientation:

Mark the contours of the panels and the field on the metal sheets with a marker or crayon. Draw lines where the mounting profiles will be: (see chapter 6.1). The high mounting profiles have a notch, making it easy to align the profiles. (view Detail A in illustration below)

Follow the instructions of the calculator for the distance between the mounting profiles. These instructions prevail.

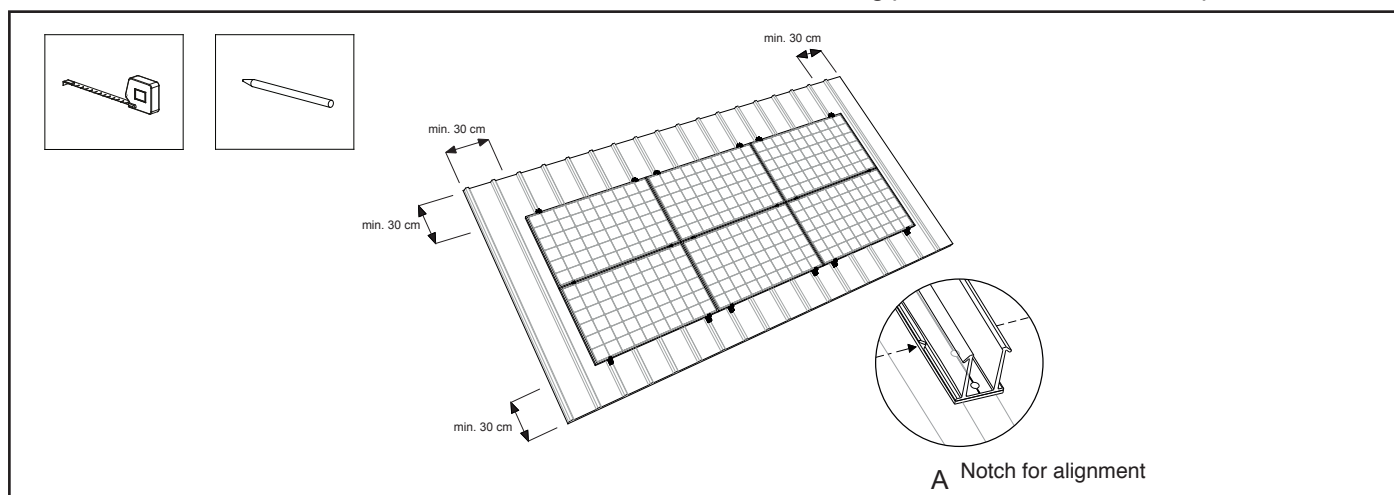

Demarcation for portrait orientation:

Draw lines where the mounting profiles will be: (see chapter 7.1). Follow the instructions of the calculator for the distance between the mounting profiles. These instructions prevail.

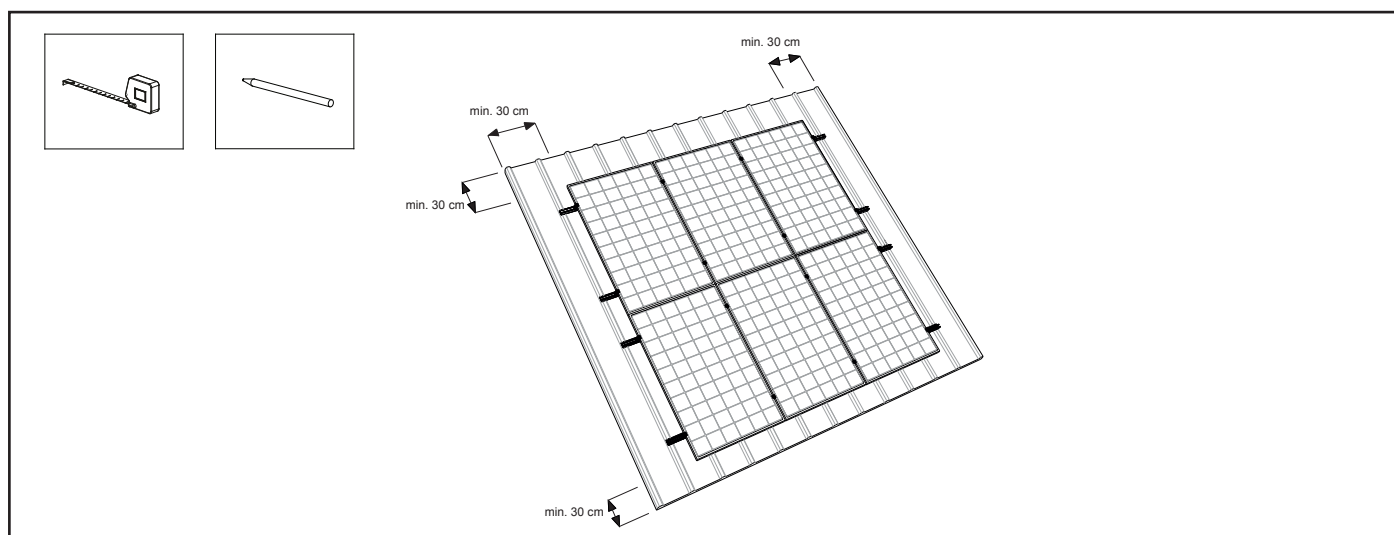

6. Installation mounting system in landscape orientation

6.1 Positioning the mounting profiles

Note! In case of a corrugated metal sheet roof, the mounting profile metal sheet roof 'Optimizer ready or Basic' landscape should be equipped with an EPDM adapter profile on the bottom (see chapter 8.2 in the attachment).



You can determine the position of the mounting profiles based on the location of the solar panels on the roof. The mounting profiles should be positioned at distance B in the upwards direction of the metal sheet roof. The mounting profiles should be positioned at distance A in the horizontal direction of the metal sheet roof. Distribute the mounting profiles (per panel) widthways parallel to the line where the solar panels will be.

Note! Make sure the mounting profiles are separately aligned.

Note! The calculator prevails when it comes to the number of screws or blind rivets per mounting profile (see application matrix in attachment).

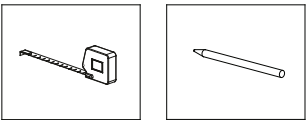
Note! In the instruction, Mounting profile metal sheet roof 'Optimizer ready' landscape is used.



Basic Landscape Product no.: 1008048 	Optimizer ready Landscape Product no.: 1008050 
--	--



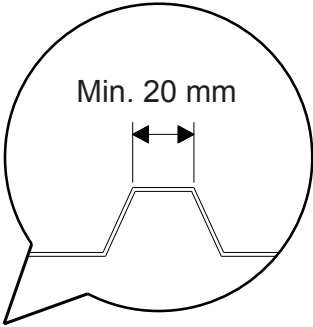

Note! The minimum width of the crown of the profile of the sheet metal roof should be 20 mm. Also make sure that the crown is flat, so that the mounting profiles fit well and seal.

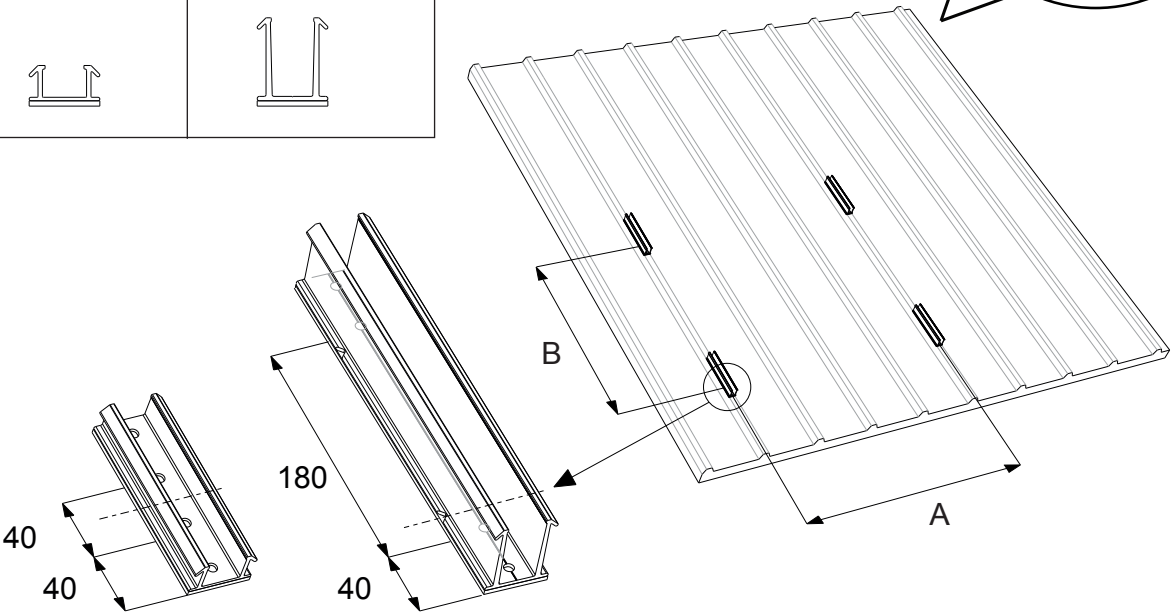



Clamp range specified by module manufacturer

or

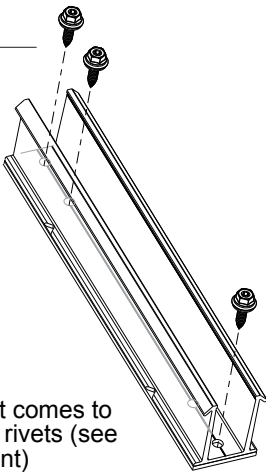



The calculator prevails when it comes to the number of screws or blind rivets (see application matrix in attachment)

6.2 Attaching the mounting profiles with screws

1. Mark the centre of the shape top of the corrugated metal sheet roof and use a crayon or marker to demarcate the location of the mounting profiles in a clear line. Only the top row of mounting profiles should be mounted below the panel with the largest part of the mounting profile. Use the 2nd notch for the correct alignment with the panel rim. The low mounting profile should be symmetrically attached to the panel rim.
2. Place the mounting profiles along the line marked on the roof. Make sure the mounting profiles are placed parallel to the shape top of the metal sheet roof. **Note!** Make sure the mounting profiles are separately aligned. Use the "notch" on the profile.
3. Screw the mounting profiles on the roof sheet using the self-tapping screw 6.0x25mm. Use a battery drill with Torx T30. **Note!** As soon as the rubber on the screw changes shape, the screw is attached and the roof is waterproof. **Note!** The calculator prevails when it comes to the number of screws per mounting profile (see application matrix in attachment).

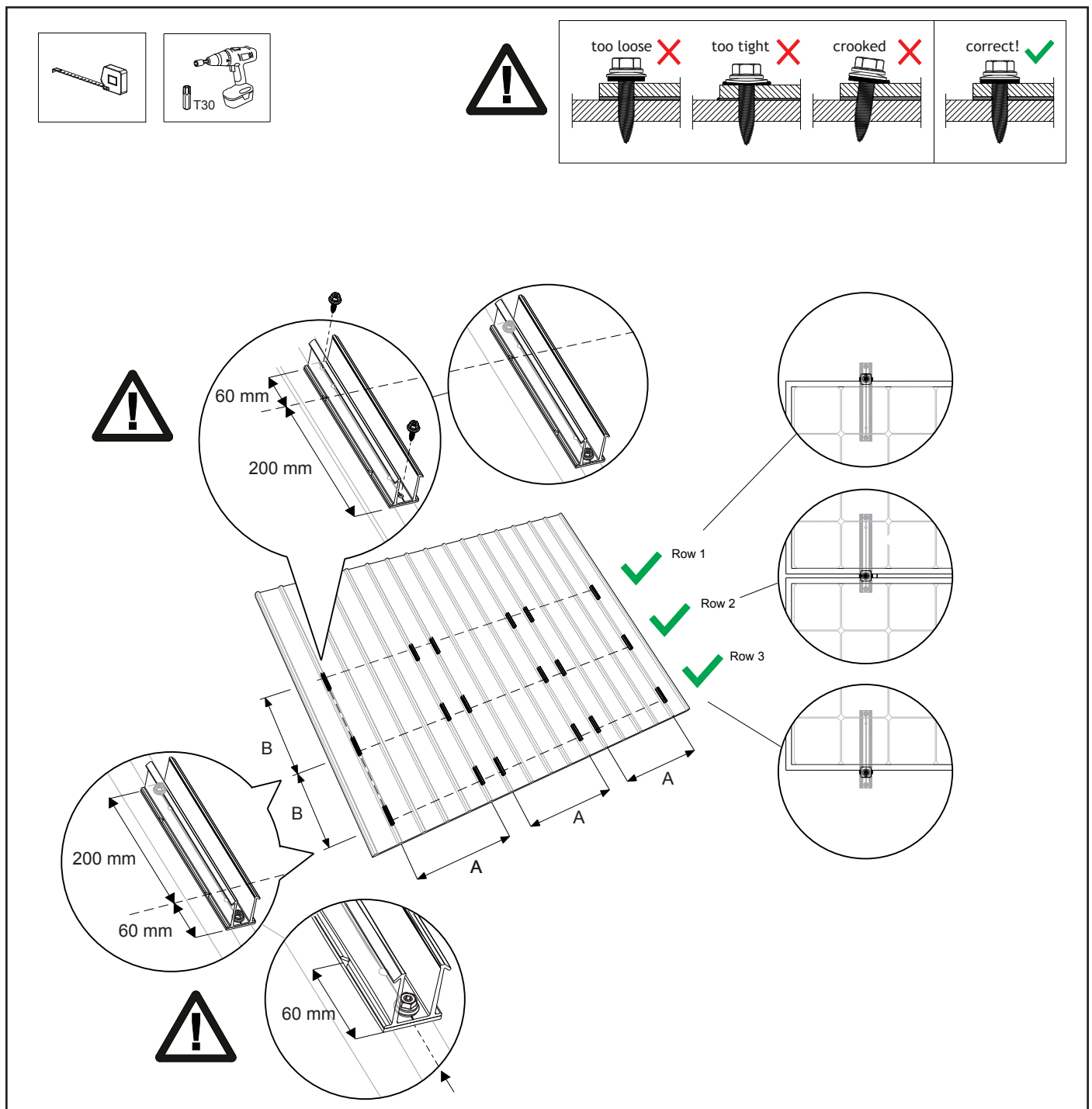

6.3 Attaching the mounting profiles with blind rivets

1. Mark the centre of the shape top of the corrugated metal sheet roof and use a crayon or marker to demarcate the location of the mounting profiles in a clear line. Only the top row of mounting profiles should be mounted below the panel with the largest part of the mounting profile. Use the 2nd notch for the correct alignment with the panel rim. The low mounting profile should be symmetrically attached to the panel rim.
2. Place the mounting profiles along the line marked on the roof. Make sure the mounting profiles are placed parallel to the shape top of the metal sheet roof. **Note!** Make sure the mounting profiles are separately aligned. Use the "notch" on the profile.
3. Drill a first hole in the roof material by using the Steeldeck rail as jig for the placement of the hole and mount the rail with one rivet in the first hole.
4. Realign the Steeldeck rail to the correct position.
5. Drill all necessary holes.
6. Mount all necessary rivets.

Note! The calculator prevails when it comes to the number of rivets per mounting profile (see application matrix in attachment).

Removing rivets

Note! Blind rivets can be removed by drilling them out with drill bit 6,0mm (so **NOT** with drill bit 6,5mm).

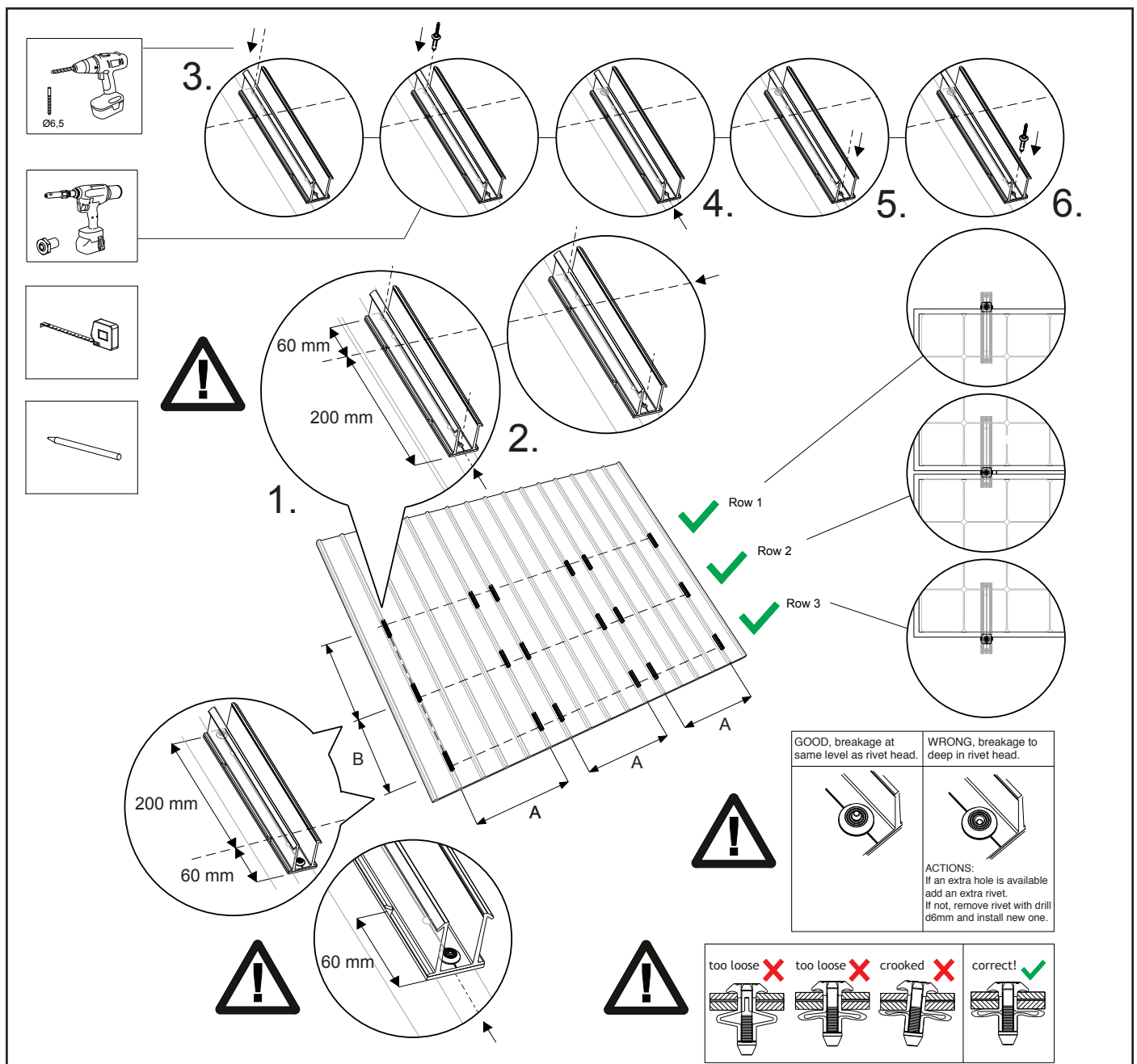

6.4 Mounting Clickfit EVO MLPE clip Light or Heavy Weight (option)

Note! Do not attach Clickfit EVO MLPE clips and MLPE devices to the top row of mounting profiles, row 1. The clips and MLPE devices can only be connected to the rows that have the 200-mm side of the mounting profile at the top (above the universal module clamp). In this situation, this is rows 2 and 3.

Mounting Clickfit EVO MLPE Clip Light Weight

1. Click the clip onto the mounting profile, below the panel.
Make sure the clip is placed at least 15 cm away from the end of the profile.
2. Slide the MLPE device onto the Light Weight clip until it is secured.
3. Secure the clip (including MLPE device) to the mounting profile by slightly bending the profile rim using water pump pliers.
4. Click the cables into the clip. Other cable tracers can be placed in the rail and/or fixed to the rail.

Mounting Clickfit EVO MLPE Clip Heavy Weight (for MLPE devices exceeding 2kg)

1. Slide the Heavy Weight clip onto the MLPE device.
2. Fasten the clip with the bolt to the MLPE device. Tighten the bolt properly. **Attention!** The tightening moment of the bolt connection is 8-12 Nm.
3. Fasten the Heavy Weight clip with the MLPE device to the mounting profile.

Note! For larger MLPE devices (equipped with 2 slots), it is essential to use two Heavy Weight clips.

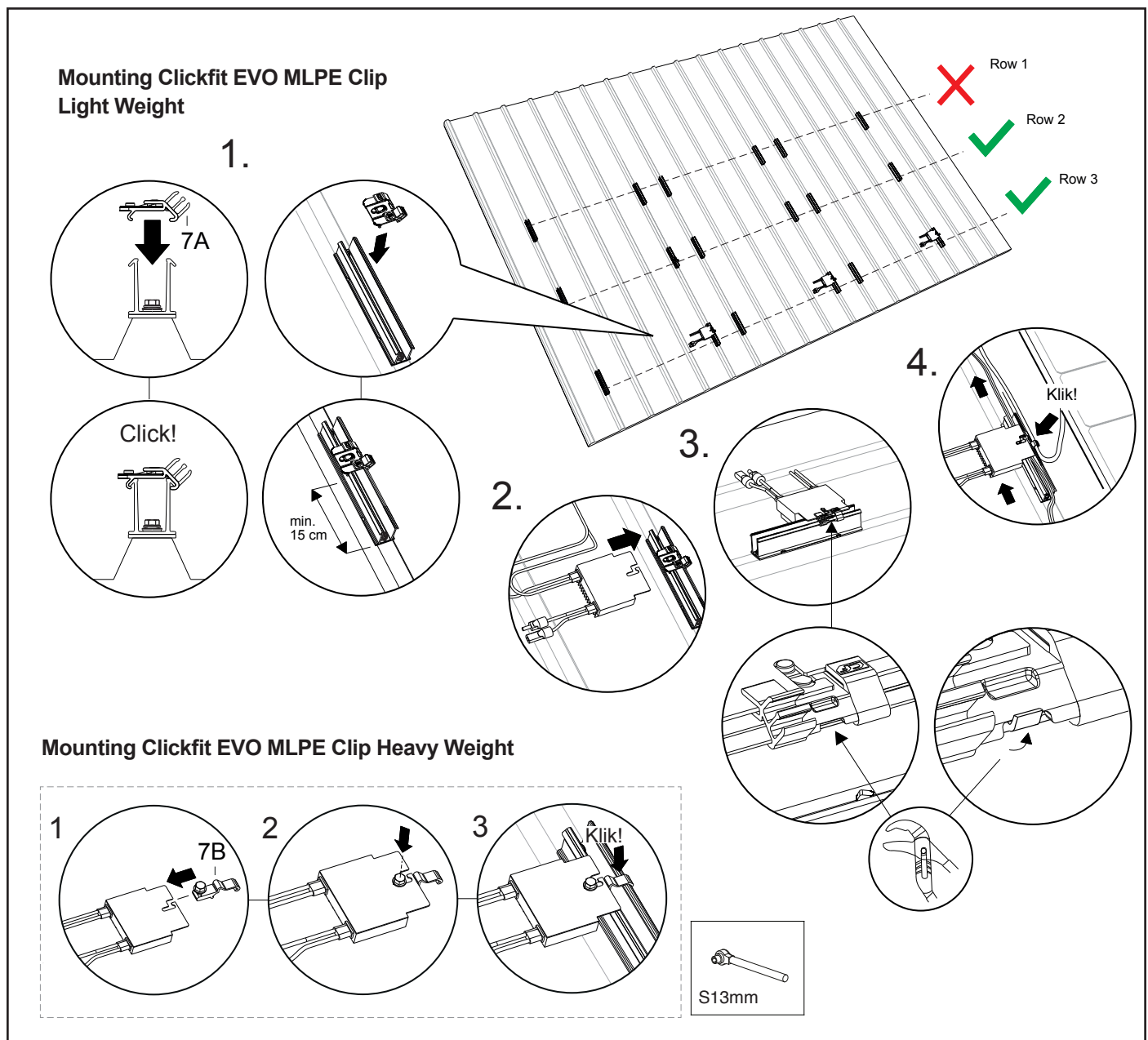

6.5 Installation of 1st solar panel on mounting profiles

1. Click the universal module clamp onto the top two mounting profiles.
2. Slide the end clamp support onto the mounting profiles and slide the end clamp support over the universal module clamp.
3. Turn the lip of the universal module clamp to the back.
4. Place the first solar panel on the top four mounting profiles and slide these against the two end clamp supports.
Choose the right height to ensure the universal module clamp fits the solar panel.
Screw the module (end) clamps in place. Make sure the mounting profile extends 20 to 30 mm. **Note!** The tightening torque of the screw connection is exactly 4.5 Nm. With a higher tightening torque, there is a risk that the module (end) clamps will bend.
5. Then click the universal module clamps onto the mounting profiles at the bottom of the solar panel. Choose the right height to ensure the universal module clamp fits the solar panel.
6. **Note!** Do not tighten these universal module clamps yet.

Note! The minimum panel thickness $Y = 29$ mm and the maximum panel thickness $X = 50$ mm

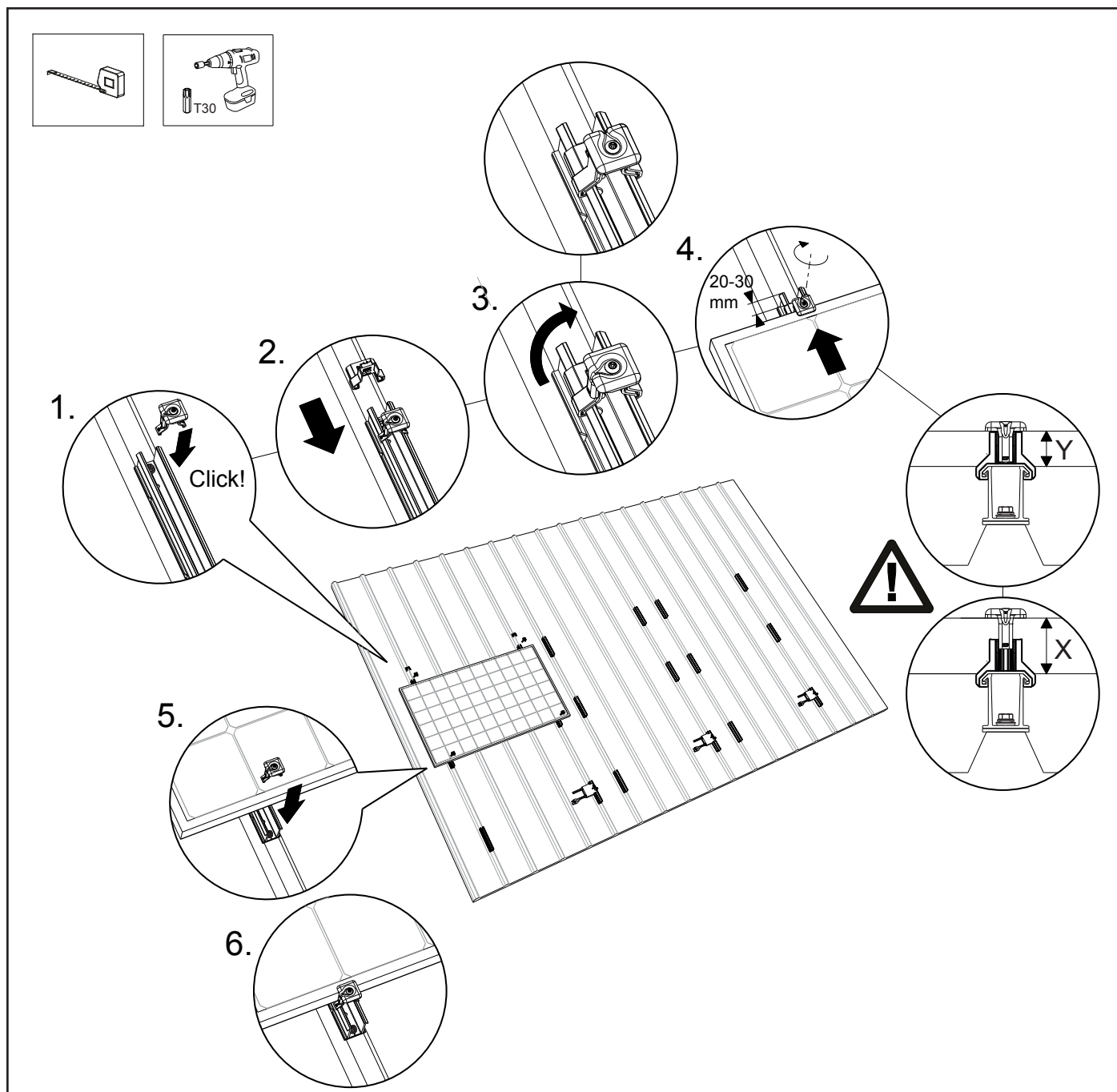

6.6 Installation of other solar panels on the mounting profiles

1. Slide the next solar panel between the mounting profiles and the universal module clamps. Afterwards, tighten the universal module clamps. **Note!** The tightening torque of the screw connection is exactly 4.5 Nm. With a higher tightening torque, there is a risk that the module (end) clamps will bend. Repeat this step if there are more intermediate panels. **Note!** To obtain a continuous panel surface, the solar panels must be placed directly above each other. Care must be taken to ensure that a gap of 12mm is maintained.
Always follow the project plan that comes out of the calculator, and the module manufacturer's installation manual.
2. Click universal module clamps onto the bottom mounting profiles and slide these against the solar panel.
3. Slide the end clamp support onto the mounting profiles. Slide the end clamp support over the universal module, against the solar panel. Choose the right height to ensure the universal module clamp fits the solar panel.
4. Turn the lip of the universal module clamp to the back.
5. Screw the module (end) clamps in place. Make sure the mounting profile extends 20 to 30 mm. **Note!** The tightening torque of the screw connection is exactly 4.5 Nm. With a higher tightening torque, there is a risk that the module (end) clamps will bend.

Note! Make sure the solar panels are straight before tightening the Torx screw!

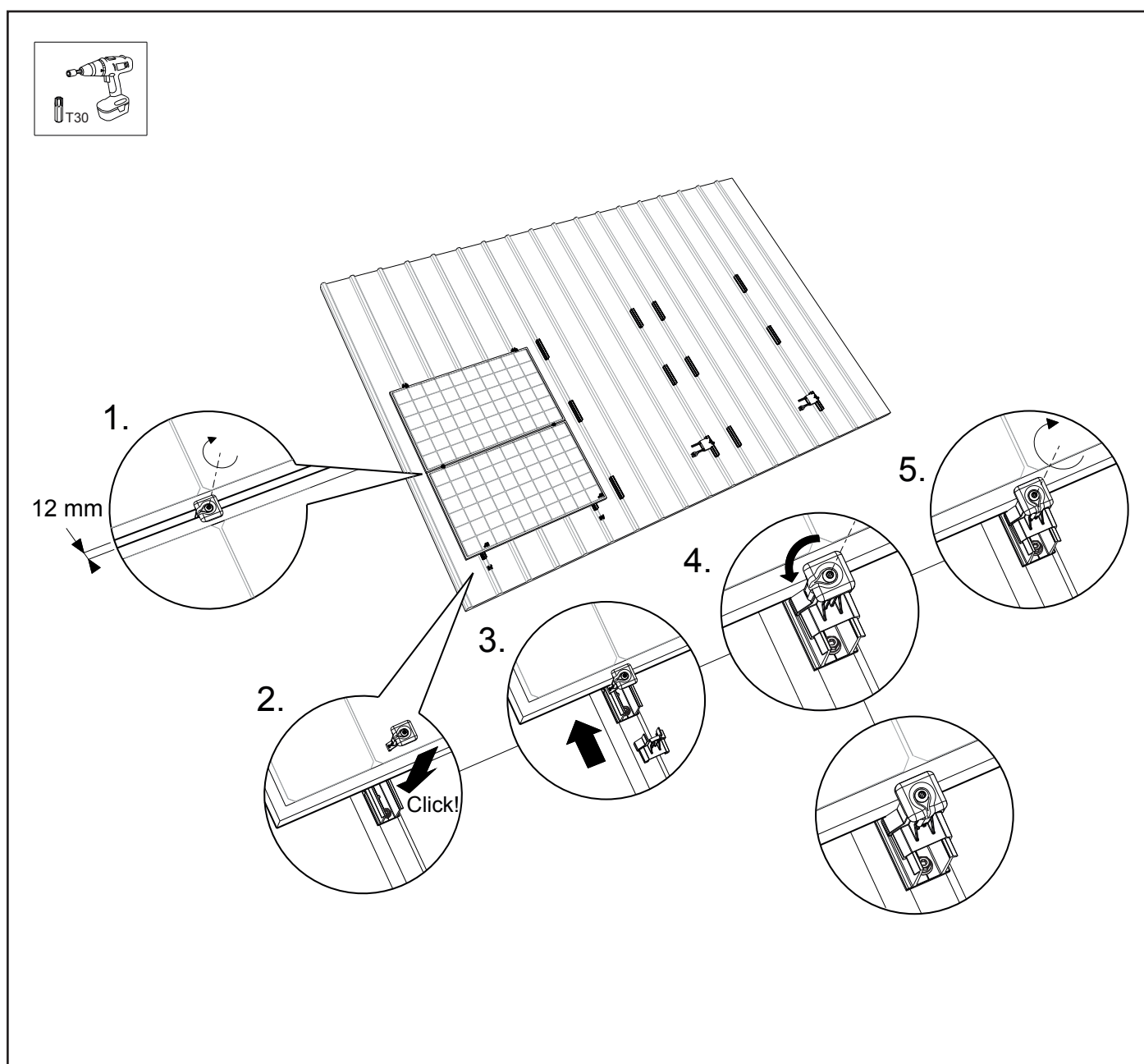

6.7 Final assembly / multiple rows

1. In order to get a connected solar panel surface, slide the adjacent solar panels against the row of solar panels.
Care must also be taken here to ensure that a gap of 12mm is maintained. Always follow the project plan that comes out of the calculator and the module manufacturer's installation manual.
2. Repeat the steps from chapter 6.5 - 6.6. The solar panel field is now complete!

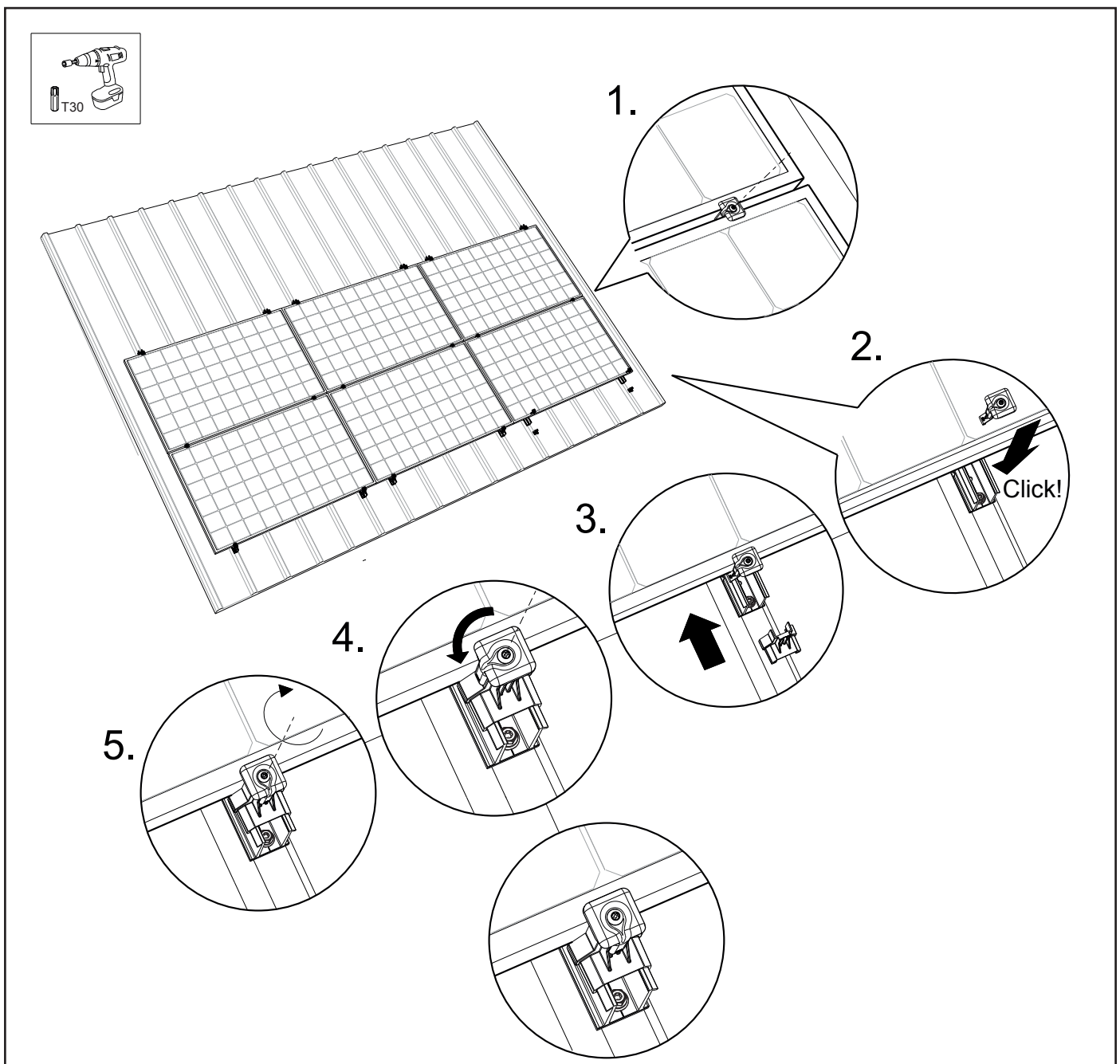

7. Installation mounting system in portrait orientation

7.1 Positioning the mounting profiles

You can determine the position of the mounting profiles based on the location of the solar panels on the roof.
The mounting profiles should be positioned at distance A in the upwards direction of the metal sheet roof.
Make sure the hole pattern of the mounting profile corresponds to the shape top centre of the metal sheet roof.
Make sure the flange of the mounting profile is aimed upwards. Distribute the mounting profiles (per panel) widthways parallel to the line where the solar panels will be.
The mounting profiles should be positioned at distance B in the upwards direction of the metal sheet roof.

Note! Make sure the mounting profiles are separately aligned.

Note! The calculator prevails when it comes to the number of mounting profiles (see application matrix in attachment).

Note! In the instruction, Mounting profile steel roof 'Optimizer ready' portrait is applied.

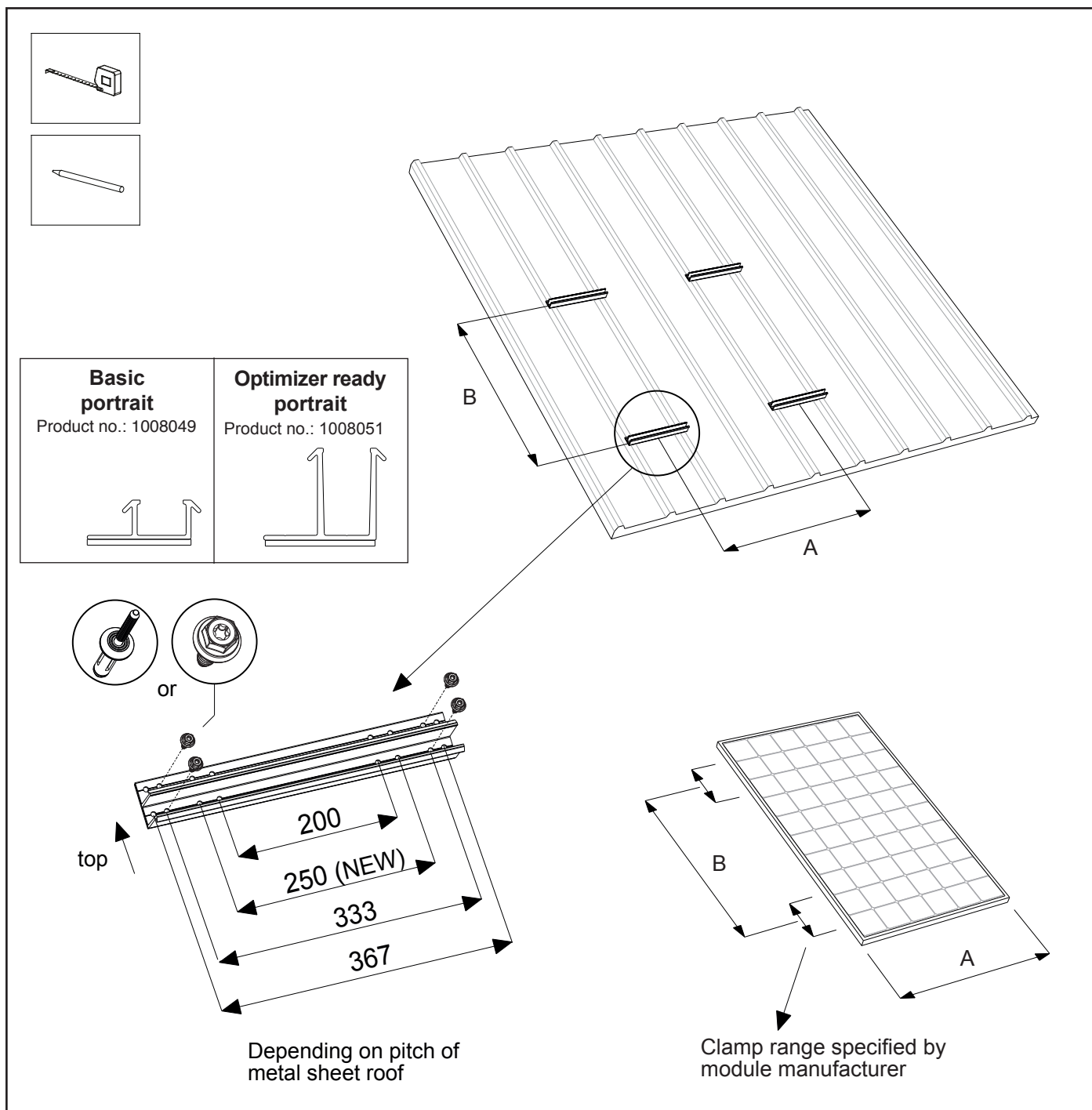

7.2 Attaching the mounting profiles with screws

1. Mark the centre of the shape top of the corrugated metal sheet roof and use a crayon or marker to demarcate the location of the mounting profiles in a clear line.
2. Place the mounting profiles along the line marked on the roof. Make sure the mounting profiles are perpendicular to the shape top of the metal sheet roof. **Note!** Make sure the mounting profiles are separately aligned. Make sure the hole pattern of the mounting profile corresponds to the shape top centre of the metal sheet roof.
3. Screw the mounting profiles on the roof sheet using the self-tapping screw 6.0x25mm. Use a battery drill with Torx 30. **Note!** As soon as the rubber on the screw changes shape, the screw is attached and the roof is waterproof.

Note! The calculator prevails when it comes to the number of mounting profiles (see application matrix in attachment).

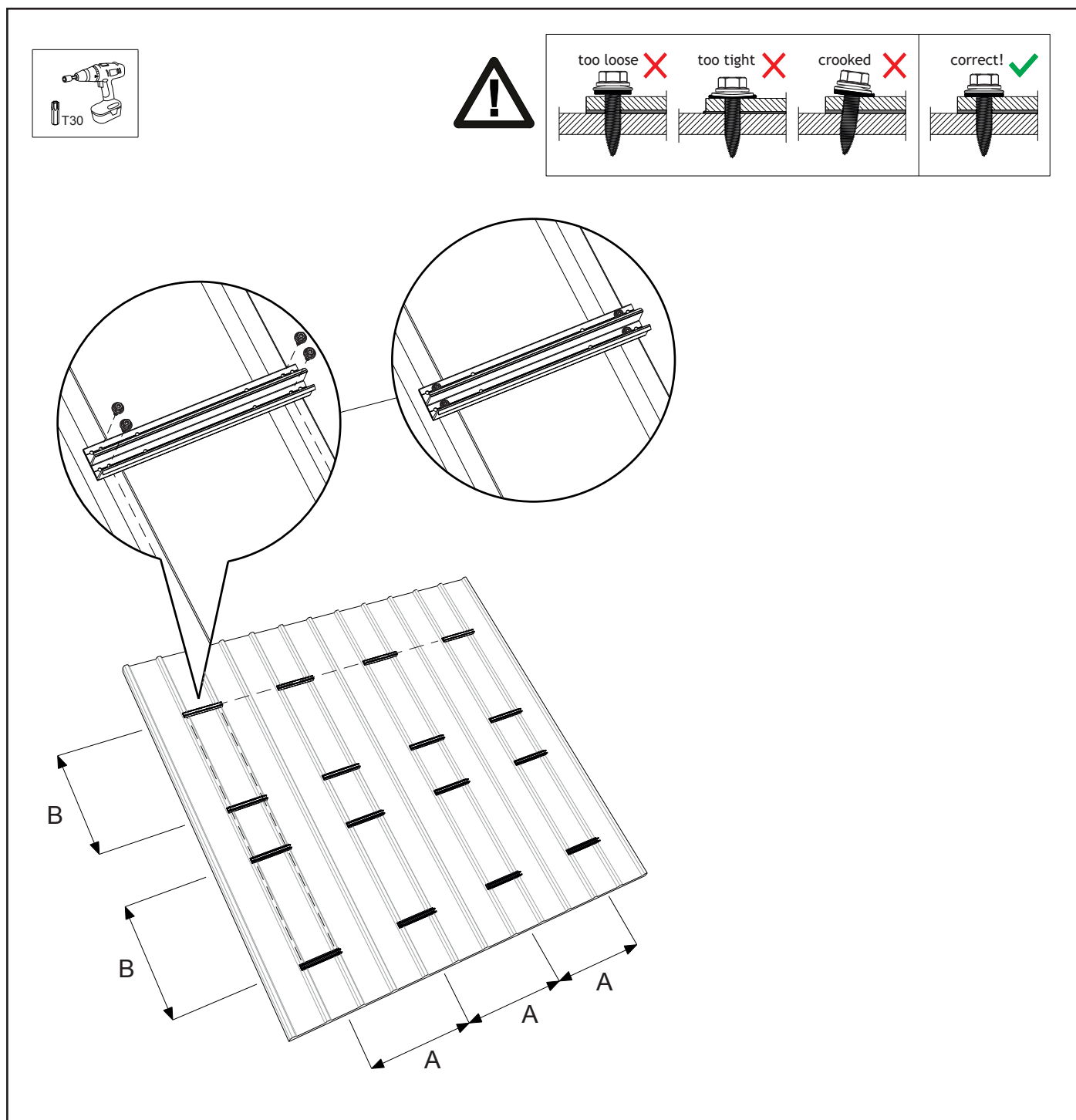

7.3 Attaching the mounting profiles with blind rivets

1. Mark the centre of the shape top of the corrugated metal sheet roof and use a crayon or marker to demarcate the location of the mounting profiles in a clear line.
2. Place the mounting profiles along the line marked on the roof. Make sure the mounting profiles are perpendicular to the shape top of the metal sheet roof. **Note!** Make sure the mounting profiles are separately aligned. Make sure the hole pattern of the mounting profile corresponds to the shape top centre of the metal sheet roof.
3. Drill a first hole in the roof material by using the Steeldeck rail as jig for the placement of the hole and mount the rail with one rivet in the first hole.
4. Realign the Steeldeck rail to the correct position.
5. Drill all necessary holes.
6. Mount all necessary rivets.

Note! The calculator prevails when it comes to the number of rivets per mounting profile (see application matrix in attachment).

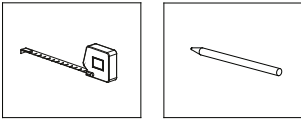

Removing rivets

Note! Blind rivets can be removed by drilling them out with drill bit **6,0mm** (so **NOT** with drill bit 6,5mm).

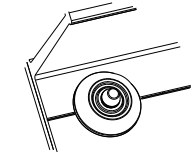
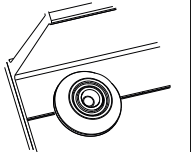

<p>GOOD, breakage at same level as rivet head.</p> 	<p>WRONG, breakage too deep in rivet head.</p> 
<p>ACTIONS: If an extra hole is available add an extra rivet. If not, remove rivet with drill d6mm and install new one.</p>	

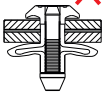

<p>too loose X</p> 	<p>too loose X</p> 	<p>crooked X</p> 	<p>correct! ✓</p> 
--	---	---	--

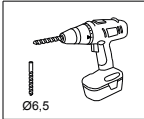

Ø6.5

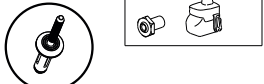

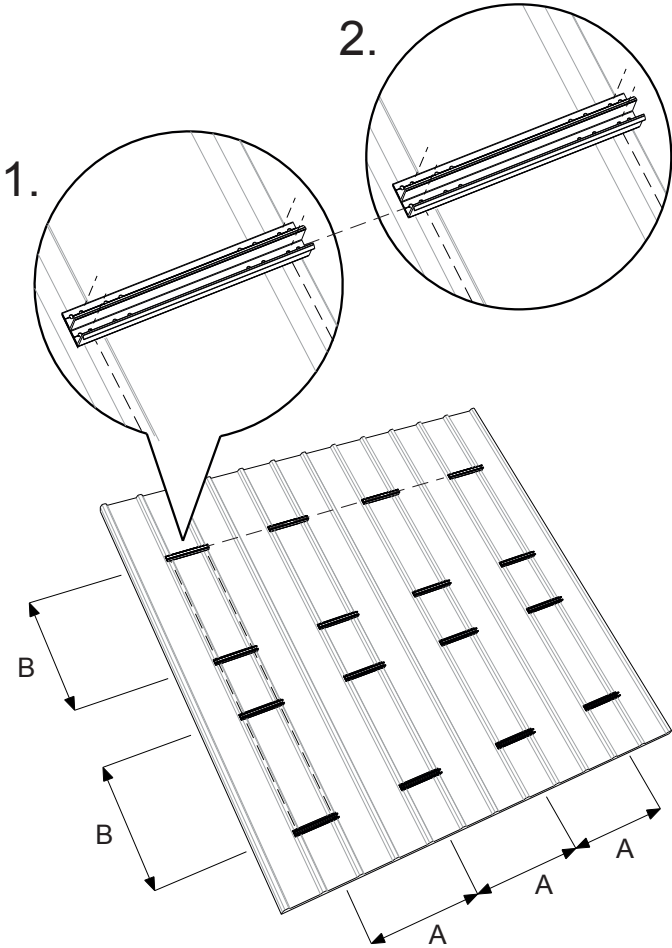

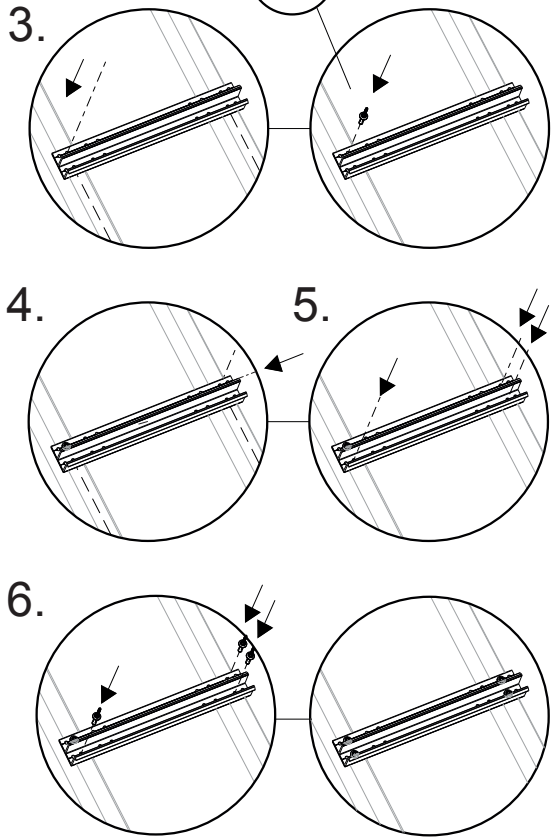

7.4 Mounting Clickfit EVO MLPE clip Light or Heavy Weight (option)

Mounting Clickfit EVO MLPE Clip Light Weight

1. Click the clip onto the mounting profile, below the panel.

Note! Make sure the clip is placed between the upwards open parts of the roof sheet. (See detail below, MLPE device zone)

2. Slide the MLPE device onto the Light Weight clip until it is secured.

3. Click the cables into the clip. Other cable tracers can be placed in the rail and/or fixed to the rail.

Mounting Clickfit EVO MLPE Clip Heavy Weight (for MLPE devices exceeding 2kg)

1. Slide the Heavy Weight clip onto the MLPE device.

2. Fasten the clip with the bolt to the MLPE device. Tighten the bolt properly. **Attention!** The tightening moment of the bolt connection is 8-12 Nm.

3. Fasten the Heavy Weight clip with the MLPE device to the mounting profile.

Note! For larger MLPE devices (equipped with 2 slots), it is essential to use two Heavy Weight clips.

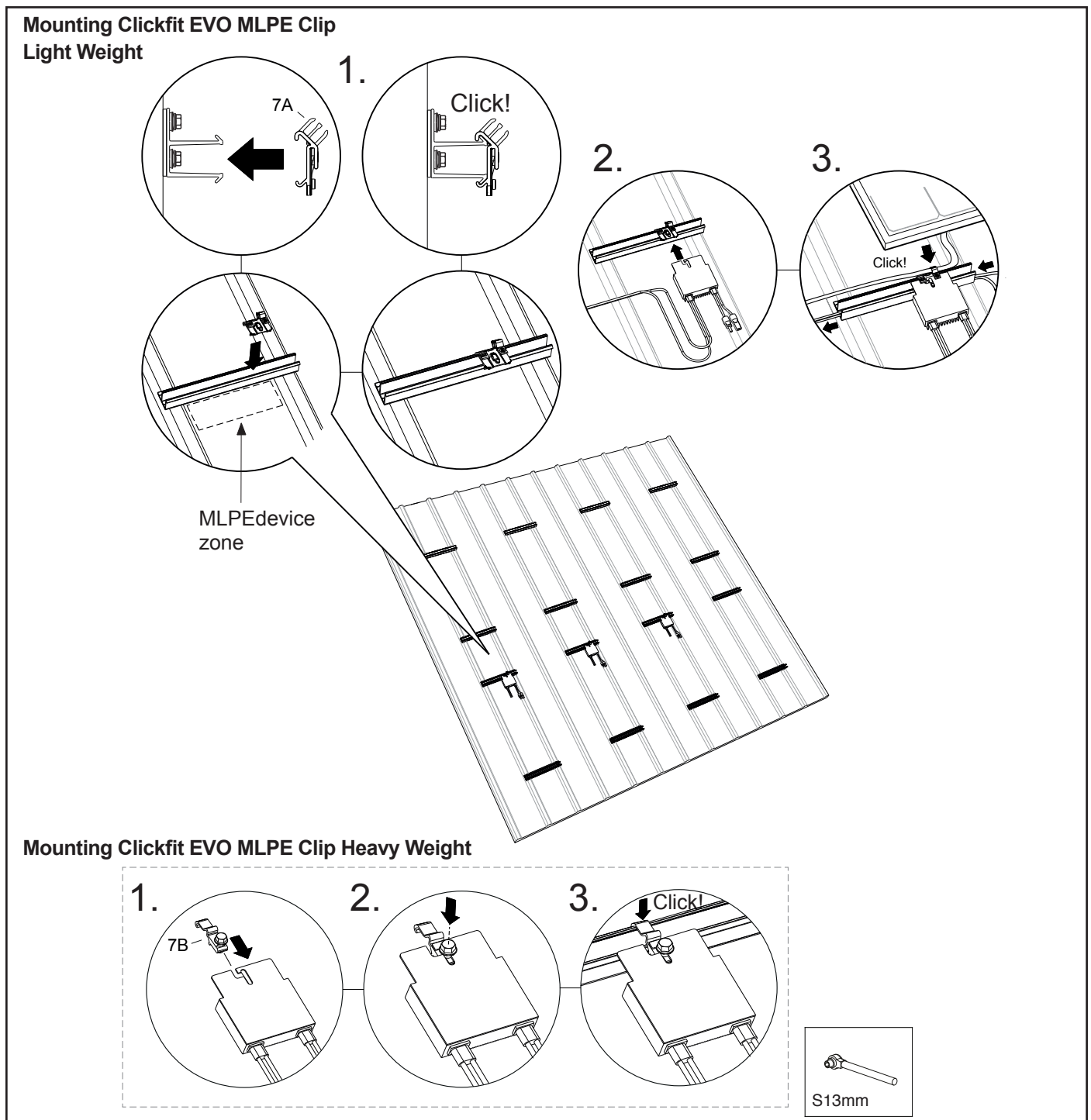

7.5 Installation of 1st solar panel onto mounting profiles

1. Click the universal module clamp onto the top two left mounting profiles. Then slide them to the centre of the mounting profile.
2. Slide the end clamp support onto the mounting profiles and slide the end clamp support over the universal module clamp.
3. Turn the lip of the universal module clamp outwards.
4. Place the first solar panel on the top four mounting profiles and slide these against the two end clamp supports.
Choose the right height to ensure the universal module clamp fits the solar panel.
Screw the module (end) clamps in place.
5. Then click the universal module clamps onto the mounting profiles on the other side of the solar panel. Choose the right height to ensure the universal module clamp fits the solar panel.
6. **Note!** Do not tighten these universal module clamps yet.

Note! The minimum panel thickness $Y = 29 \text{ mm}$ and the maximum panel thickness $X = 50 \text{ mm}$

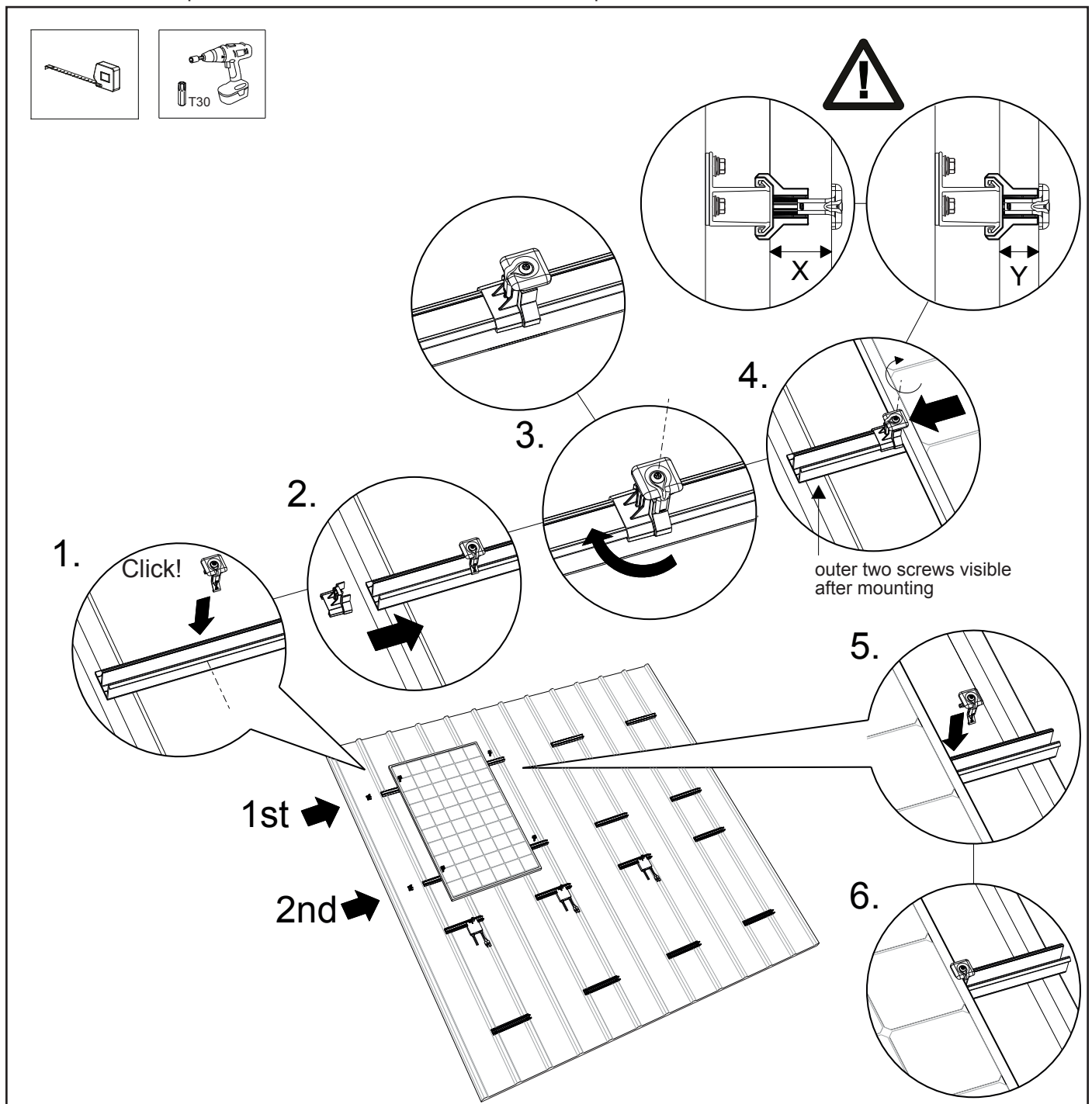

7.6 Installation of other solar panels on the mounting profiles

1. Slide the next solar panel between the mounting profiles and the universal module clamps.

Note! To obtain a continuous panel surface, the solar panels must be placed right next to each other. Care must be taken to ensure that a gap of 12mm is maintained.

Always follow the project plan that comes out of the calculator, and the module manufacturer's installation manual.

Note! Make sure the module clamp is always between the screw locations. Screw the universal module clamps in place.

Note! The tightening torque of the screw connection is exactly 4.5 Nm. With a higher tightening torque, there is a risk that the module (end) clamps will bend.

2. Then click the universal module clamps onto the mounting profile on the other side of the solar panel. Choose the right height to ensure the universal module clamp fits the solar panel.

3. **Note!** Do not tighten these universal module clamps yet.

Repeat this step if there are more intermediate panels.

Note! Make sure the solar panels are straight before tightening the Torx screw! Repeat this for the remaining solar panels.

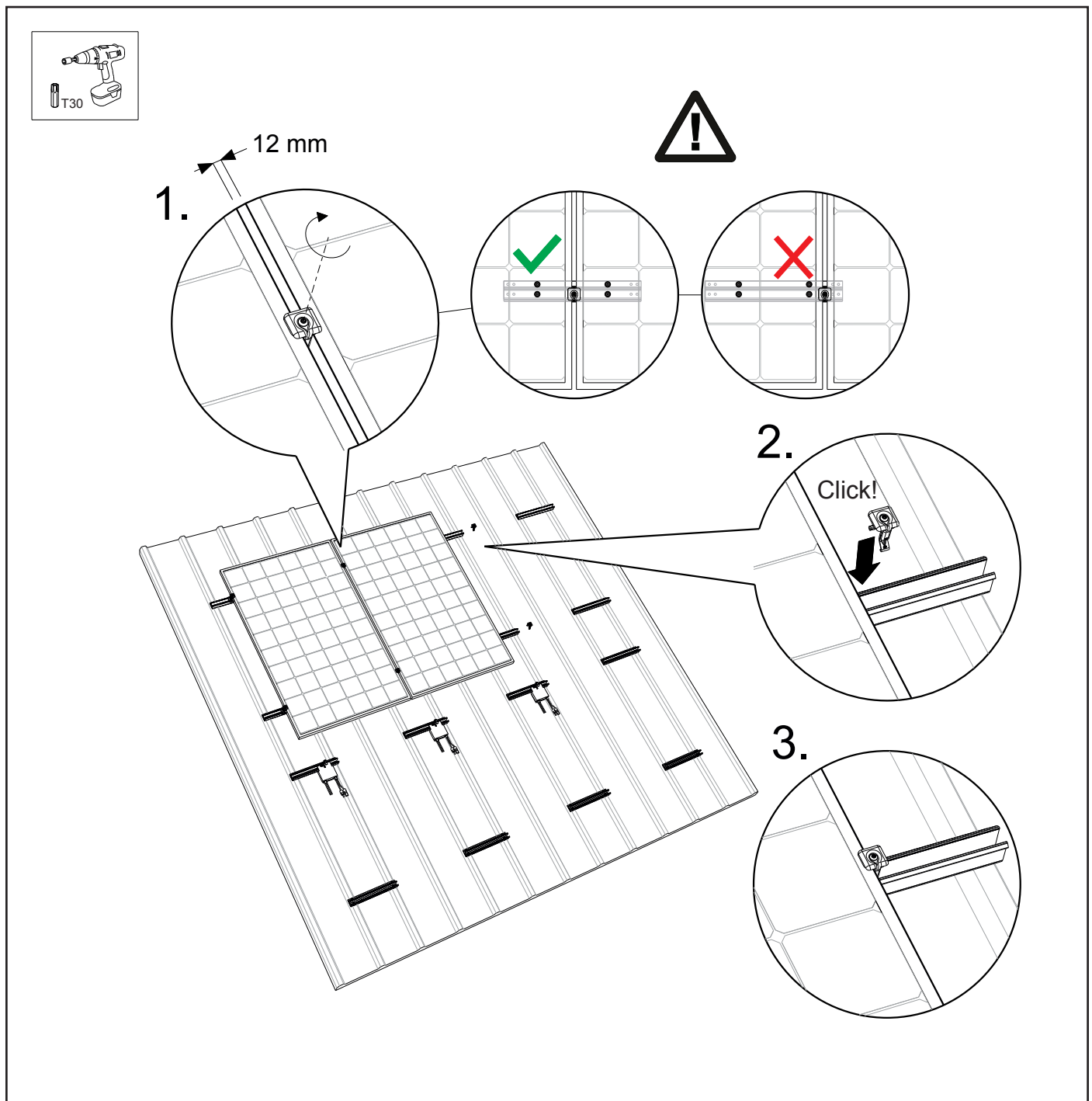

7.7 Final assembly 1st row of adjacent solar panels

1. Slide the last solar panel in the row between the mounting profiles and the universal module clamps. Afterwards, tighten the universal module clamps. **Note!** The tightening torque of the screw connection is exactly 4.5 Nm. With a higher tightening torque, there is a risk that the module (end) clamps will bend.
2. Click the universal module clamp onto the top two right mounting profiles. Then slide them towards the solar panel.
3. Slide the end clamp support onto the mounting profiles and slide the end clamp support over the universal module clamp against the solar panel. Choose the right height to ensure the universal module clamp fits the solar panel.
4. Turn the lip of the universal module clamp outwards.
5. Screw the module (end) clamps in place. **Note!** Make sure the mounting profile always extends so that outer screws are still visible. **Note!** The tightening torque of the screw connection is exactly 4.5 Nm. With a higher tightening torque, there is a risk that the module (end) clamps will bend.

Note! Make sure the solar panels are straight before tightening the Torx screw!

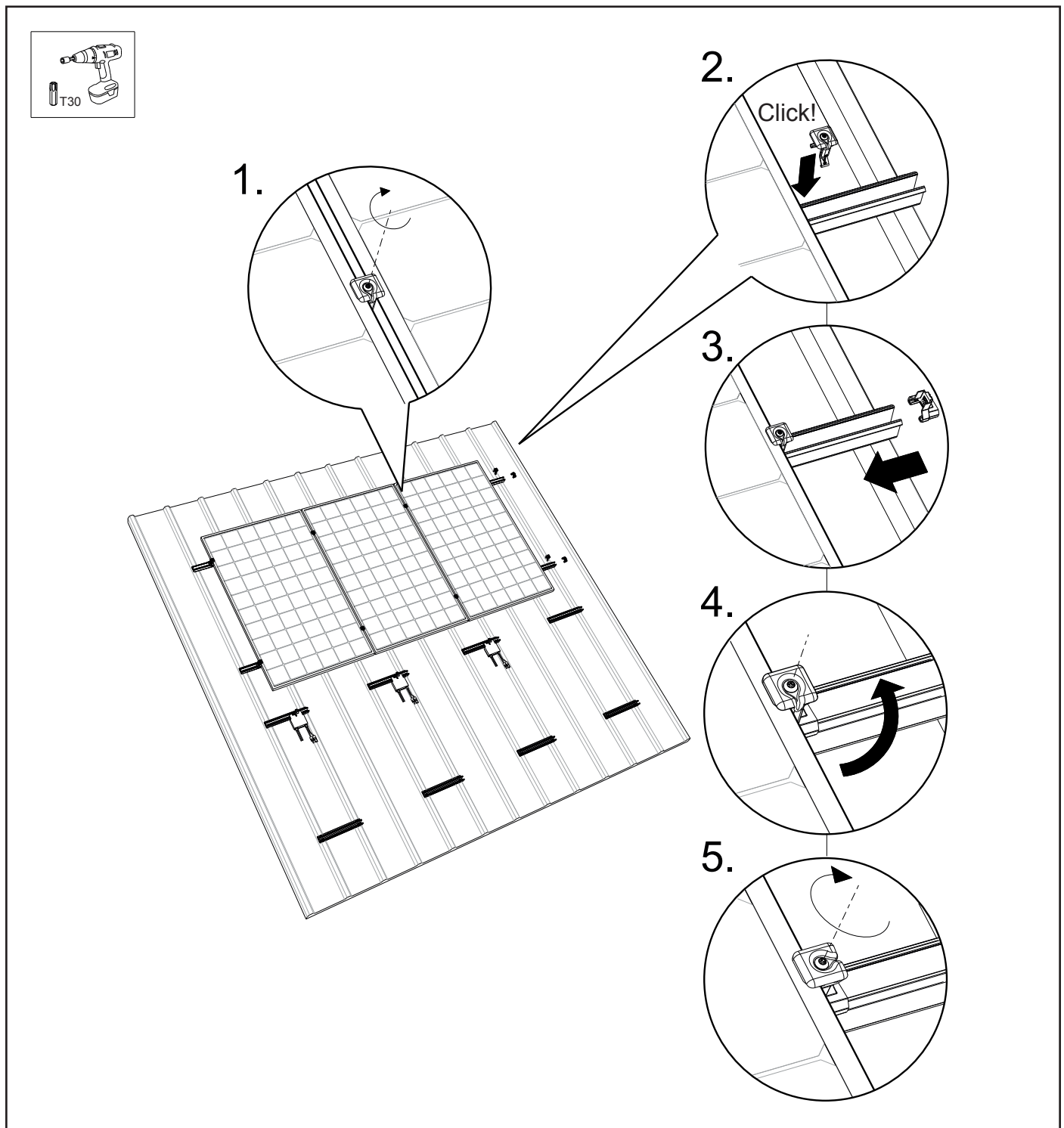

7.8 Final assembly / multiple rows below each other

1. In order to get a connected solar panel surface, slide the solar panels below against the row of solar panels.
Care must also be taken here to ensure that a gap of 12mm is maintained. Always follow the project plan that comes out of the calculator and the module manufacturer's installation manual.
2. Repeat the steps from chapter 7.5 - 7.6 and finalise the solar panels according to step 1 - 5 below. The solar panel field is now complete!

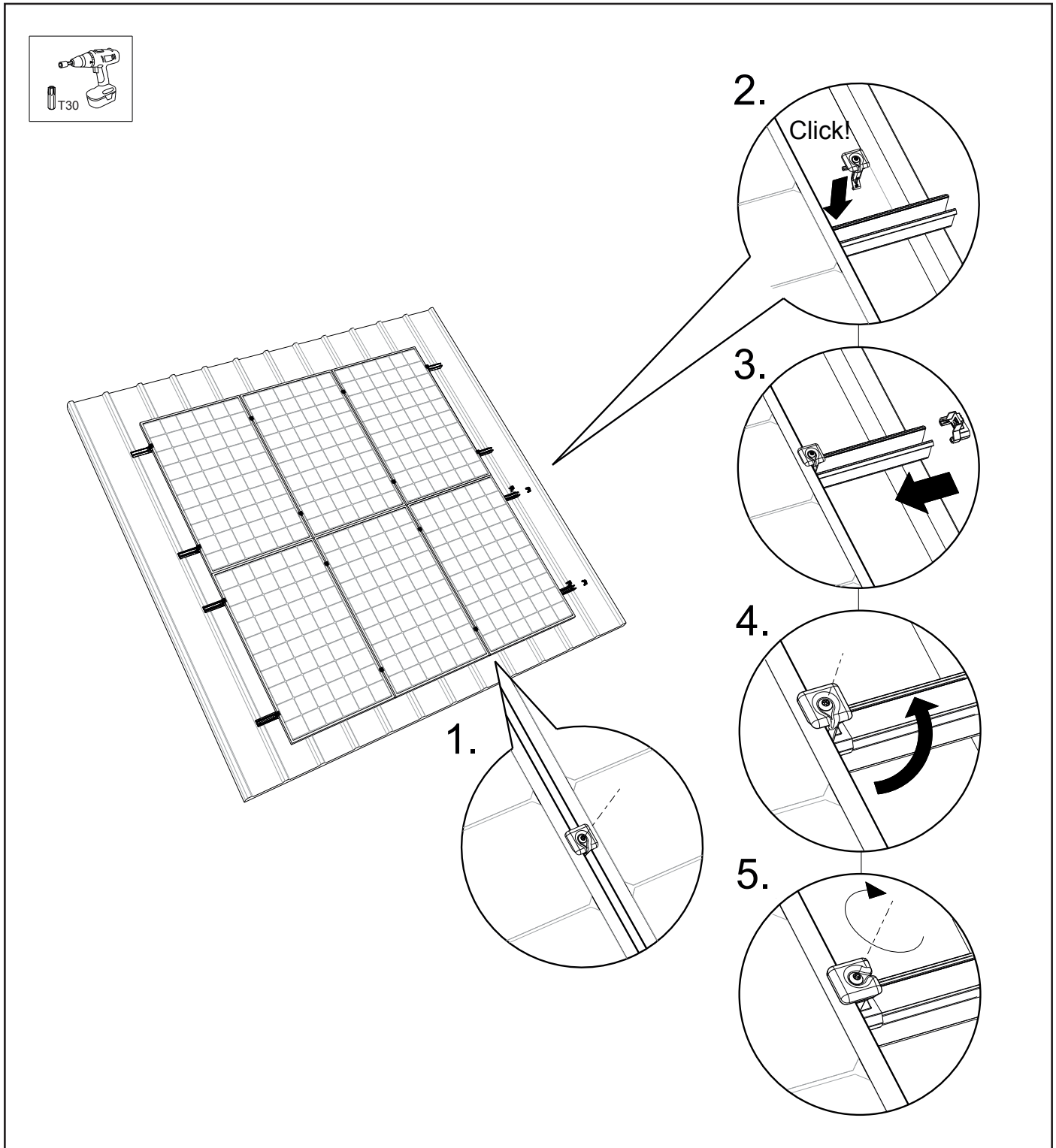



8. ATTACHMENT

8.1 Application matrix

Following tables do show per orientation, module surface category and wind load category, the minimal required profiles per module and minimal required fasteners per profile. Both tables do only reflect on roof mid-zones conform Eurocode. Check also the Esdec calculator for your project plan (www.esdec.com)

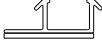

8.1.1 Installation with SCREW (Item 1008085)



	1. Situation			2. Amount of PROFILES per module	3. Amount of SCREWS per profile				
	Module Orientation + profile item nr.	Max surface [m ²]	Max windload [N/m ²]		material	Steel			
						min t*	0,5mm	1,0mm	1,5mm
						max t*	1,0mm	1,5mm	>1,5mm
low profiles	Landscape + 1008048 	1,7	981	4		2	2	2	
			1165	4		2	2	2	
		2,1	981	4		2	2	2	
			1165	4		3	2	2	
		2,6	981	4		3	2	2	
			1165	4		4	2	2	
	Portrait + 1008049 	1,7	981	4		4	4	4	
			1165	4		4	4	4	
		2,1	981	4		4	4	4	
			1165	4		4	4	4	
		2,6	981	4		4	4	4	
			1165	4		4**	4	4	
high profiles (optimizer ready)	Landscape + 1008050 	1,7	981	4		4	2	2	
			1165	4		4	2	2	
		2,1	981	4		4	2	2	
			1165	4		4**	2	2	
		2,6	981	4		4**	2	2	
			1165	4		4**	2	2	
	Portrait + 1008051 	1,7	981	4		4	4	4	
			1165	4		4	4	4	
		2,1	981	4		4	4	4	
			1165	4		4	4	4	
		2,6	981	4		4	4	4	
			1165	4		4**	4	4	

*) sheet metal thickness

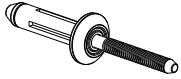
***) in combination with 6 profiles per module

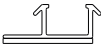

8.1.2 Installation with RIVET (Item 1008087)

	1. Situation			2. Amount of PROFILES per module	3. Amount of RIVETS per profile						
	Module Orientation + profile item nr.	Max surface [m ²]	Max windload [N/m ²]		Steel			Aluminium***			
					material	0,5mm	1,0mm	1,5mm	0,5mm	1,0mm	1,5mm
					min t*	1,0mm	1,5mm	>1,5mm	1,0mm	1,5mm	>1,5mm
low profiles	Landscape + 1008048 	1,7	981	4	2	2	2	2	2	2	2
			1165	4	2	2	2	2	2	2	
		2,1	981	4	2	2	2	2	2	2	
			1165	4	2	2	2	3	2	2	
		2,6	981	4	2	2	2	3	2	2	
			1165	4	3	2	2	4	2	2	
	Portrait + 1008049 	1,7	981	4	4	4	4	4	4	4	4
			1165	4	4	4	4	4	4	4	
		2,1	981	4	4	4	4	4	4	4	
			1165	4	4	4	4	4	4	4	
		2,6	981	4	4	4	4	4	4	4	
			1165	4	4	4	4	4**	4	4	
high profiles (optimizer ready)	Landscape + 1008050 	1,7	981	4	2	2	2	2	2	2	
			1165	4	2	2	2	4	2	2	
		2,1	981	4	2	2	2	4	2	2	
			1165	4	4	2	2	2**	3	2	
		2,6	981	4	4	2	2	3**	4	2	
			1165	4	2**	2	2	4**	4	2	
	Portrait + 1008051 	1,7	981	4	4	4	4	4	4	4	
			1165	4	4	4	4	4	4	4	
		2,1	981	4	4	4	4	4	4	4	
			1165	4	4	4	4	4	4	4	
		2,6	981	4	4	4	4	4	4	4	
			1165	4	4	4	4	4**	4	4	

*) sheet metal thickness

**) in combination with 6 profiles per module

***) in combination with 1008081 or 1008082 (EPDM Corrugated shape profiles) in all cases 4 RIVETS per profile

8.2 Installation of the corrugated adapter profile for landscape installations

Note! In case of a corrugated metal sheet roof, the mounting profile metal sheet roof 'Optimizer ready or Basic' landscape should be equipped with an EPDM adapter profile on the bottom. The EPDM adapter profile has an indentation at the bottom, allowing it to properly fit the corrugated metal sheet roof.

Follow the steps below to mount the mounting profile onto the EPDM adapter profile.

1. Position the mounting profile above the EPDM adapter profile.
2. Slide the mounting profile to the side in the adapter profile.
3. Push the rubber rim (flap) around the profile edge.
4. The mounting profile is ready for mounting on the corrugated metal sheet roof. (See chapter 6.1 Positioning the mounting profiles).

