

Shutters/Blinds Actuator CJAU-01/04..

Slim 18 mm design

ESM
230VAC
50Hz
μ 3A
CE
EAT•N
CJAU-01/04-I
xComfort
PROG
MODE
L
N
PE

Program
Mode

Local input

Actuator	Type
CJAU-01/04	
CJAU-01/04-I	With local input

Technical Data / Technische gegevens / Tekniske data / Technische Daten / Technická data

Power supply	230 VAC +10% -15%, 50 Hz
Load	3 A, L/R
Power standby	< 200 mW (Typical)
Local input	230 VAC (Max. 265 V)
Input contact resistance In to L	> 10 kΩ reliably ON > 50 kΩ reliably OFF
Voltage difference IN to L	< 1 V reliably ON > 3 V reliably OFF
Protection	Overload, Over-temperature
Dimensions	49.5 x 45.5 x 18 mm (H x W x D)
RF	868,3MHz (xComfort compatible)
Max RF power	25mW (ERP)

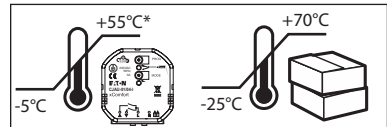

MRF	Version 2.78
ESM	Version: 41a Version: 2.00 Version: 2.00 Version: 2.00 Version: 3.10
RM SHC-RF ECI-RF USB-RF xComfort Bridge	



www.eaton.com/xcomfort



CJAU-01/04

CJAU-01/04-I

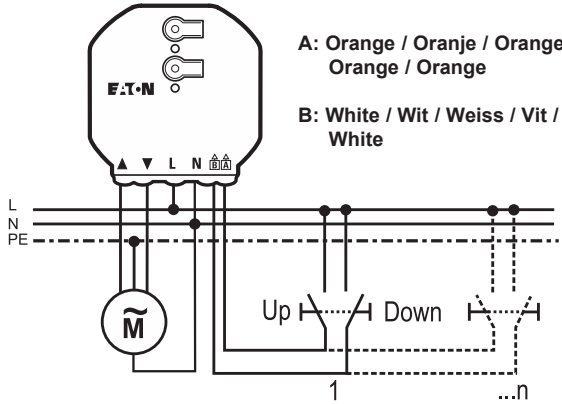
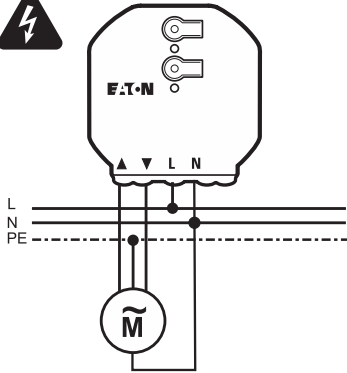

A: Orange / Oranje / Orange / Orange / Orange

B: White / Wit / Weiss / Vit / White

Basic mode

Assign Sensor in Basic Mode / Sensor in Basic Mode toewijzen / Tilknytte i Basic Mode / Zuweisen im Basic Mode / Přihadit v základním režimu

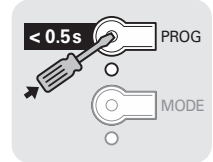
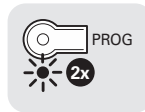
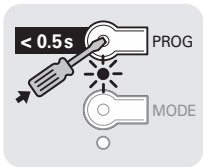

Remove Sensor in Basic Mode // Sensor in Basic Mode verwijderen / Fjerne i Basic Mode / Löschen im Basic Mode / Odstranit v základním režimu

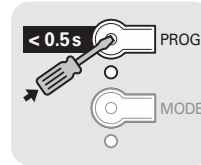
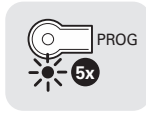
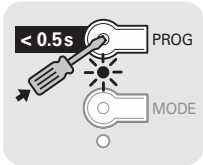

Configure application mode / Toepassingsmodus configureren / Konfigurer applikasjonsmodus / Anwendungsmodus konfigurieren / Konfigurace režimu aplikace

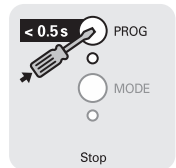
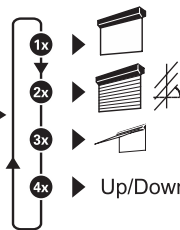
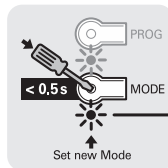
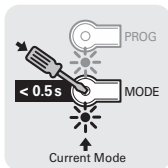
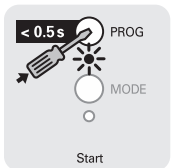

Identify in MRF /
Identificeren in MRF /
Identifiser i MRF /
Identifizieren im MRF /
Identifikace v MRF

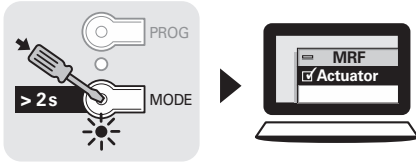

Back to factory default /
Terug naar fabriekinstellingen /
Tilbake til fabrikkinnstillinger /
Auf Auslieferungszustand zurücksetzen /
Zpět na tovární hodnoty

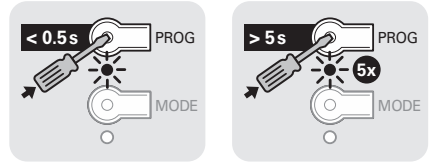



Declaration of Conformity

We, EATON Industries (Austria) GmbH
3943 Schrems, Eugenia 1
Austria

declare under our sole responsibility as manufacturer that the product (family)

Eaton - Shutters / Blinds Actuator UP

CJAU-01/04..

(the declaration of conformity applies to all listed types within our actual product catalogue)

provided that it is installed, maintained and used in the application intended for, with respect to the relevant manufacturer's instructions, installation standards and "good engineering practices"

complies with the provisions of Council directive(s):

RED Directive 2014/53/EU

RoHS Directive 2011/65/EU + 2015/863

based on compliance with following standard(s):

EN 300220-2 V3.2.1, EN 301489-3 V2.1.1, EN 301 489-1 V2.2.3, EN IEC 63044-5-1:2019, EN IEC 63044-5-2:2019, EN IEC 63044-5-3:2019, EN 60669-2-5:2016, EN 63000:2018



Schrems, 11.11.2021

Gerhard Dischner

Director Operations

Friedrich Schröder

Director Quality

Affixing date of CE mark: 2021

Doc.Id.: CJAU_01-04_11112021

