

Productinformatieblad

Specificaties

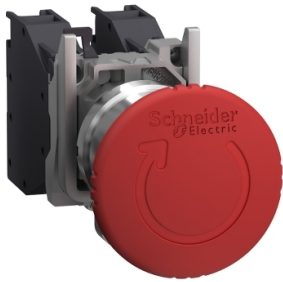

Harmony XB4 - ATEX Noodstopkno voor explosieve omgevingen - Metaal - 2NC - Draaiontgrendeling

XB4BS8444GEX

EAN Code: 3606481517098

Prijs: 245,25 EUR

Hoofd

range of product	Harmony XB4
product of component type	Complete drukknop voor noodstop
device short name	XB4
kraag materiaal	Verchroomd metaal
materiaal bevestigingskraag	Zamak
bevestigingsdiameter	22 mm
verkoop per ondeelbare hoeveelheid	1
stof zone	Zone 21 - 22
gas zone	Zone 1 - 2
type operator	activeringsactie en mechanische vergrendeling
reset	Draaien om te ontgrendelen
operator profiel	Rood paddestoel Ø 40
type en samenstelling contacten	1 NC +1 NC

Complementair

breedte	46,2 mm
hoogte	30 mm
diepte	119,5 mm
gewicht product	0,140 kg
montage apparaat	Bevestigingsgat - diameter: 22,5 mm +/-0.2 mm In overeenstemming met IEC 60947-1
bevestigingspunt	>= 30 x 40 mm (steunpaneel) - dikte: 1...6 mm
inbouwdiepte	58 mm
markering	II 2 GD Ex tb IIIC Db Ex db eb IIC Gb
vorm van kop signaleringsseenheid	Rond
werking contacten	Slow-break
contact gebruik	Standaard
positieve opening	Met In overeenstemming met IEC 60947-5-1 bijlage K
mechanical durability	5000000 cycles

De weergegeven prijs is de adviesprijs in euro excl. BTW. Deze kan onderhevig zijn aan korting. Neem contact op met uw lokale distributeur of detailhandel voor de daadwerkelijke prijs

aansluitingen - aansluitklemmen	Schroefklem aansluitingen, 2 x 1,5 mm ² met kabeluiteinde In overeenstemming met IEC 60947-1 Schroefklem aansluitingen, 1 x 2,5 mm ² zonder kabeluiteinde In overeenstemming met IEC 60947-1
aanspanmoment	0,8...1,2 N.m In overeenstemming met IEC 60947-1
Ith conventionele thermische stroom in vrije lucht	10 A In overeenstemming met IEC 60947-5-1
Ui nom isolatiespanning	415 V
Ie nom. bedrijfstrom	1,9 A om 380 V, AC, A600 In overeenstemming met IEC 60947-5-1 3 A om 240 V, AC, A600 In overeenstemming met IEC 60947-5-1 6 A om 120 V, AC, A600 In overeenstemming met IEC 60947-5-1 0,27 A om 250 V, GELIJKSTROOM, Q300 In overeenstemming met IEC 60947-5-1 0,55 A om 125 V, GELIJKSTROOM, Q300 In overeenstemming met IEC 60947-5-1 2,87 A om 24 V, GELIJKSTROOM, Q300 In overeenstemming met IEC 60947-5-1

Omgeving

beschermende behandeling	TH
ambient air temperature for storage	-40...70 °C
omgevingstemperatuur voor werking	-20...65 °C
IP beschermingsgraad	IP65 In overeenstemming met IEC 60529
standards	IEC 60079-0:2009 EN/IEC 60079-1:2009 IEC 60079-7:2009 IEC 60079-31:2009 UL 60079-0 UL 60079-1 UL 60079-31 ANSI/ISA 12.12.01 CSA C22.2 Nr 213
product certifications	INERIS 04ATEX9004U

Verpakkingseenheid

Eenheidstype van verpakking 1	PCE
Aantal eenheden in verpakking 1	1
verpakking 1 hoogte	3,900 cm
verpakking 1 breedte	5,800 cm
verpakking 1 lengte	7,500 cm
verpakking_1_gewicht	138,000 g

contractuele waarborg

Garantie (in maanden)	18
------------------------------	----

Schneider Electric wil tegen 2050 de Net Zero-status hebben bereikt via partnerschappen in de toeleveringsketen, materialen met een lagere impact en circulariteit via onze doorlopende campagne "Use Better, Use Longer, Use Again" om de levensduur van producten en de recycleerbaarheid te verlengen.

[Uitleg van Environmental Data >](#)

[Hoe evalueren we de duurzaamheid van producten? >](#)

Milieuoetafdruk

Milieu Profiel

[Milieuprofiel van het product](#)

Use Better

Materialen en verpakking

Gemiddeld percentage gerecycleerde kunststof

16 %

Gemiddeld percentage gerecycleerd metaal

20 %

Pakket met gerecycleerd karton

Ja

Verpakkingen zonder kunststof

Nee

RoHS-richtlijn van de EU

[Conform](#)

REACH-verordening

[Referentie bevat geen SVHC boven drempelwaarde](#)

Use Longer

Levensduurverlenging

Reparatie

Nee

Productreparatie-index

[A](#)

Use Again

Herverpakken en herfabriceren

Circulair Profiel

[Informatie over einde levensduur](#)

Terugname

Ja

WEEE-label



Het product moet op markten van de Europese Unie worden afgevoerd volgens specifieke afvalinzamelingsregels en mag nooit in een gewone vuilnisbak terechtkomen.

Dimensions Drawings

Dimensions

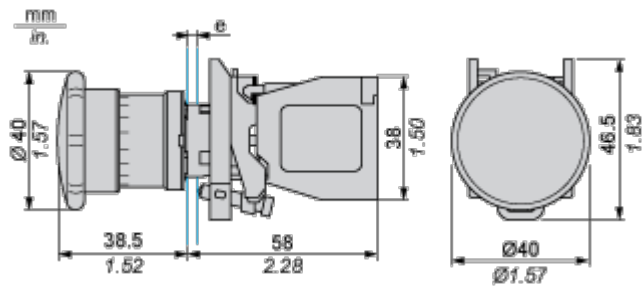

e : support thickness: 1 to 6 mm / 0.04 to 0.24 in.

Mounting and Clearance

Panel Cut-out for Pushbuttons, Switches and Pilot Lights (Finished Holes, Ready for Installation)

Connection by Screw Clamp Terminals

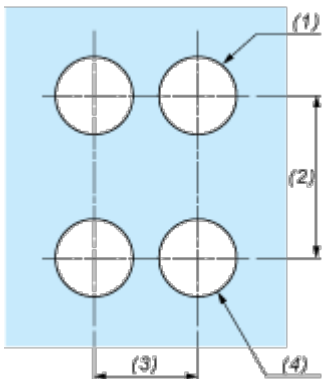

- (1) Diameter on finished panel or support
- (2) 40 mm min. / 1.57 in. min.
- (3) 30 mm min. / 1.18 in. min.
- (4) $\varnothing 22.5 \text{ mm} / 0.89 \text{ in. recommended } (\varnothing 22.3 \text{ mm }_0^{+0.4} / 0.88 \text{ in. }_0^{+0.016})$

Technical Illustration

Dimensions

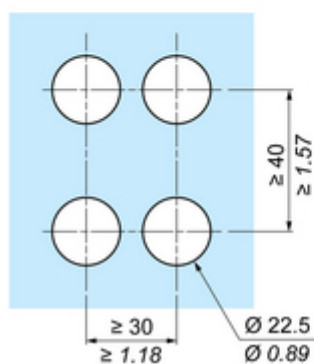
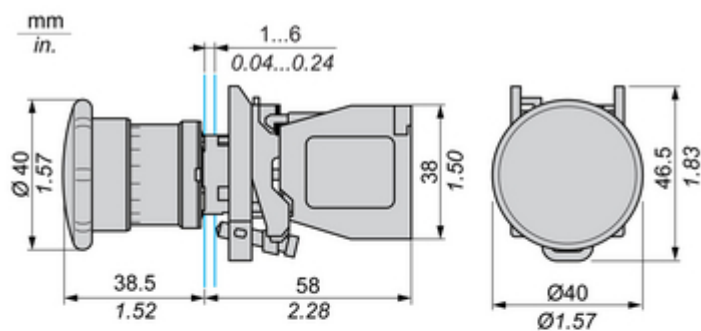



Offer Marketing Illustration

Product benefits / Features

Features
Harmony XB4 e-stop function

 Wide modular range to suit machines and operator safety.

 Ergonomic design for emergency actuation in several environments

 Designed to fit in a standard 22mm cut-out or Harmony XAPK control station ensuring compatibility with pre-existing machinery.

 Large set of accessories: circular legends, illuminated legend rings, protective bellows for harsh environments and protective guards.



Offer Marketing Illustration

Product benefits / Features

Technical Benefits

Harmony XB4 e-stop function

Fit to several customer functions needs: turn to release, push to release, key release

Guarantee of proper installation thanks to NC contact with monitoring function.



Fit for all machine sizes and environments:

- Small machines > 30 mm
- Standard machines > 40 mm
- Use of gloves > 60 mm

Designed as per international standards for high performance.

Offer Marketing Illustration

Product benefits / Features

Technical Benefits

Harmony XB4

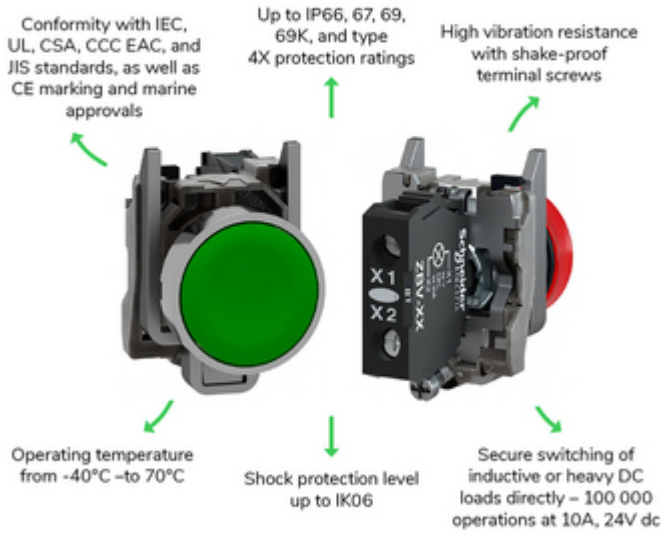

Offer Marketing Illustration

Product benefits / Features

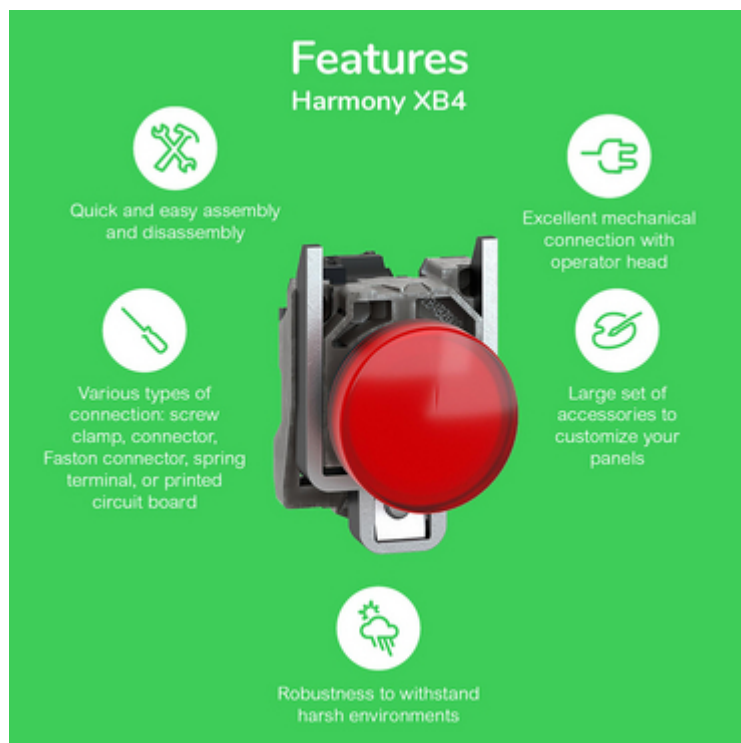

The infographic features a central image of a red Schneider XB4 terminal block. Surrounding this central image are five circular icons, each with a corresponding text description of a feature. The background is a solid green color.

Features Harmony XB4





-  Quick and easy assembly and disassembly
-  Various types of connection: screw clamp, connector, Faston connector, spring terminal, or printed circuit board
-  Excellent mechanical connection with operator head
-  Large set of accessories to customize your panels
-  Robustness to withstand harsh environments

Image of product / Alternate images

Alternative



