

Productinformatieblad

Specificaties



Modicon TM5 - Analoge ingangsmodule - 2I - Thermokoppel J/K/N/S - 16 bits

TM5SAI2TH

EAN Code: 3595864074764

Prijs: 399,90 EUR

Hoofd

range of product	Modicon TM5
product or component type	Analoge ingangsmodule
aantal analoge ingangen	2
analoog inputtype	thermokoppel - 210...1200 °C met thermokoppel J thermokoppel - 270...1300 °C met thermokoppel N thermokoppel - 270...1372 °C met thermokoppel K thermokoppel - 50...1768 °C met thermokoppel S
analoge ingangsresolutie	16 bits

Complementair

bereik compatibiliteit	Modicon M258 Modicon LMC058
compatibiliteit product	Logic controller Bewegingscontroller
meetresolutie	0,1 °C
colour	Wit
Ingangsfitering	1...66.7 ms configureerbaar door software
meetfout	+/- 0,1% van totaal - 210...1200 °C thermokoppel J bij 25 °C +/- 0,11 % van volledige grootte - 270...1300 °C thermokoppel N bij 25 °C +/- 0,11 % van volledige grootte - 270...1372 °C thermokoppel K bij 25 °C +/- 0,17 % van volledige grootte - 50...1768 °C thermokoppel S bij 25 °C
temperatuurcoëfficiënt	0,01 %FS/°C, analoog invoertype: thermokoppel
niet-lineariteit	+/- 0,001 %FS, analoog invoertype: thermokoppel
type kabel	Afgeschermd kabel
isolatie	Geen isolatie tussen kanalen 500 Vrms AC isolatie tussen kanaal en bus
voeding	Intern
Us nominale voedingsspanning	24 V DC -15...20 %
Link communicatiegegevens	> 70 dB
lokale signalering	1 LED groen voor voeding 1 LED rood voor voeding 2 LEDs groen voor inputstatus
stroomverbruik	2 mA bij 5 V DC bus 30 mA bij 24 V DC invoer/uitvoer
Maximaal vermogensverlies in W	0,73 W
markering	CE

De weergegeven prijs is de adviesprijs in euro excl. BTW. Deze kan onderhevig zijn aan korting. Neem contact op met uw lokale distributeur of detailhandel voor de daadwerkelijke prijs

net weight	0,025 kg
------------	----------

Omgeving

standards	UL 508 CSA C22.2 Nr. 142 CSA C22.2 Nr 213 IEC 61131-2
-----------	--

product certifications	CSA GOST-R C-Tick cULus
------------------------	----------------------------------

omgevingsluchttemperatuur voor werking	0...55 °C zonderverlies (horizontale installatie) 0...60 °C met (horizontale installatie) 0...50 °C (verticale installatie)
--	---

ambient air temperature for storage	-25...70 °C
-------------------------------------	-------------

relatieve vochtigheid	5...95 % zonder condensatie
-----------------------	-----------------------------

IP beschermingsgraad	IP20 conform aan IEC 61131-2
----------------------	------------------------------

pollution degree	2 conform aan IEC 60664
------------------	-------------------------

operating altitude	0...2000 m
--------------------	------------

opslaghoogte	0...3000 m
--------------	------------

trillingsweerstand	1 gn bij 8,4...150 Hz op DIN-rail 3.5 mm bij 5...8,4 Hz op DIN-rail
--------------------	--

schokbestendigheid	15 gn voor 11 ms
--------------------	------------------

weerstand tegen elektrostatische ontlading	4 kV bij contact conform aan IEC 61000-4-2 8 kV in lucht conform aan IEC 61000-4-2
--	---

weerstand tegen elektromagnetische velden	1 V/m 2...2.7 GHz conform aan IEC 61000-4-3 10 V/m 80...2000 MHz conform aan IEC 61000-4-3
---	---

weerstand tegen snelle piekspanningen	1 kV conform aan IEC 61000-4-4 (I/O) 1 kV conform aan IEC 61000-4-4 (afgeschermd kabel) 2 kV conform aan IEC 61000-4-4 (stroomlijnen)
---------------------------------------	---

bestand tegen stroompieken	0,5 kV differentieelmodus conform aan IEC 61000-4-5 1 kV gewone modus conform aan IEC 61000-4-5
----------------------------	--

elektromagnetische compatibiliteit	EN/IEC 61000-4-6
------------------------------------	------------------

verstoring uitgestraald/geleid	CISPR11
--------------------------------	---------

Verpakkingseenheid

Unit Type of Package 1	PCE
------------------------	-----

Number of Units in Package 1	1
------------------------------	---

Package 1 Height	2,000 cm
------------------	----------

Package 1 Width	6,000 cm
-----------------	----------

Package 1 Length	10,500 cm
------------------	-----------

Package 1 Weight	40,000 g
------------------	----------

Unit Type of Package 2	S02
------------------------	-----

Number of Units in Package 2	97
------------------------------	----

Package 2 Height	15,000 cm
------------------	-----------

Package 2 Width	30,000 cm
-----------------	-----------

Package 2 Length	40,000 cm
------------------	-----------

Package 2 Weight	4,263 kg
------------------	----------

contractuele waarborg

Garantie

18 months

Environmental Data

Schneider Electric wil tegen 2050 de Net Zero-status hebben bereikt via partnerschappen in de toeleveringsketen, materialen met een lagere impact en circulariteit via onze doorlopende campagne "Use Better, Use Longer, Use Again" om de levensduur van producten en de recycleerbaarheid te verlengen.

[Uitleg van Environmental Data](#) >

[Hoe evalueren we de duurzaamheid van producten?](#) >

Milieuoetafdruk

Milieuprofiel van product (PEP)

[Milieuprofiel van het product](#)

Use Better

Materialen en verpakking

Pakket met gerecycleerd karton

Nee

Verpakkingen zonder kunststof

Ja

[EU-richtlijn RoHS](#)

Voldoet pro-actief (Product valt niet onder de EU RoHS juridische scope)

REACH-regelgeving

[REACH-verklaring](#)

PVC-vrij

Ja

Use Again

Herverpakken en herfabriceren

Circulair Profiel

[Informatie over einde levensduur](#)

Terugname

No

WEEE Label

 Het product moet op markten van de Europese Unie worden afgevoerd volgens specifieke afvalinzamelingsregels en mag nooit in een gewone vuilnisbak terechtkomen.

Dimensions Drawings

TM5 Slice

Dimensions

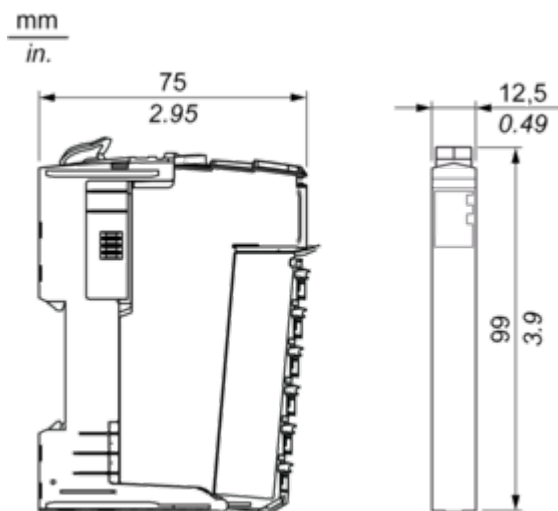

Mounting and Clearance

TM5 System

Spacing Requirements

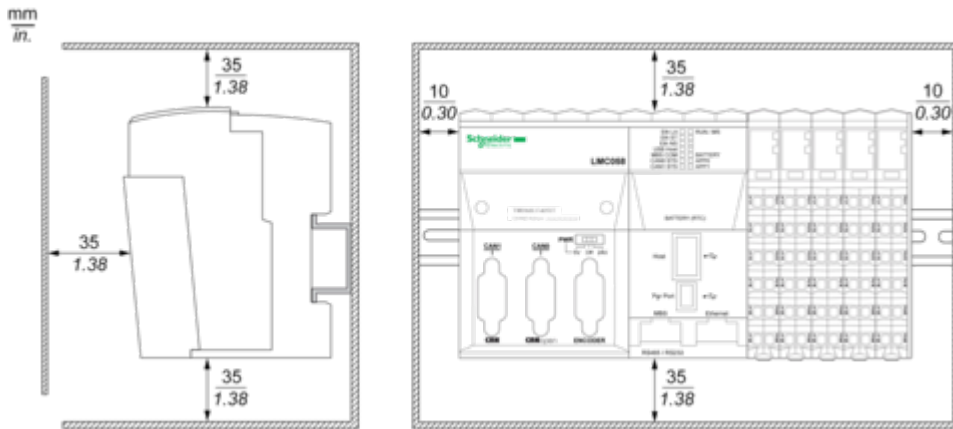



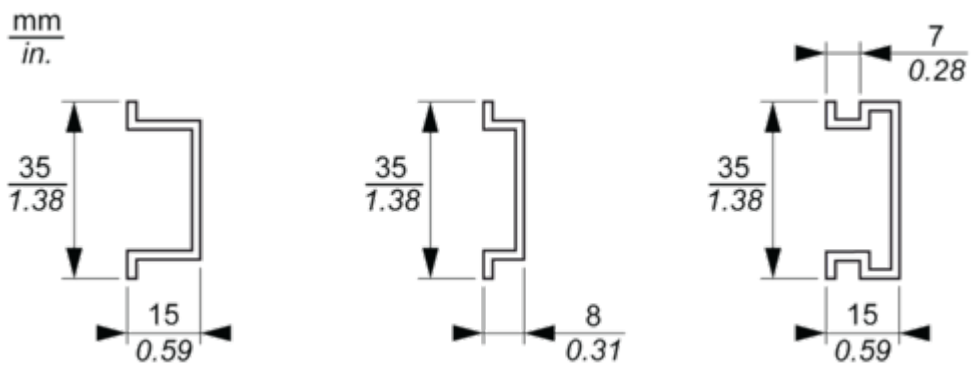

Mounting on a DIN Rail

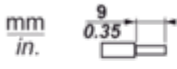

Connections and Schema

TM5 System Wiring Recommendations

Wire Sizes to Use with the Removable Spring Terminal Blocks

				
mm ²	0,08...2,5	0,25...2,5	0,25...1,5	2 x 0,25...2 x 0,75
AWG	28...14	24...14	24...16	2 x 24...2 x 18

Electronic Module 2AI Thermocouple J/K/N/S 16 Bits

Wiring Diagram

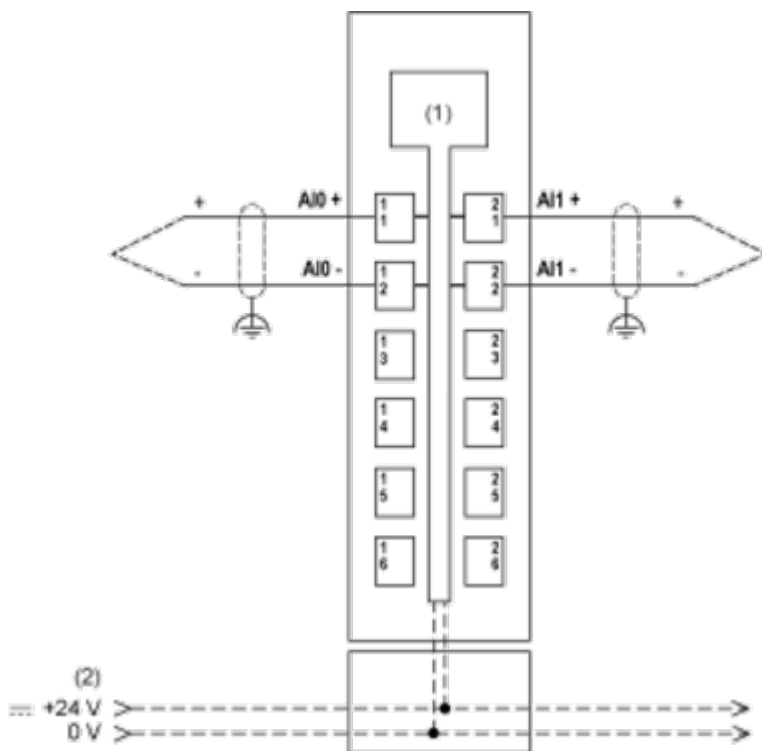

- (1) Internal electronics
- (2) 24 Vdc I/O power segment integrated into the bus bases

Ceramic Heating Element with Integrated Thermo Elements

Ripple voltage effects can potentially cause measurement errors. The following figure shows the wiring diagram with a PDM:

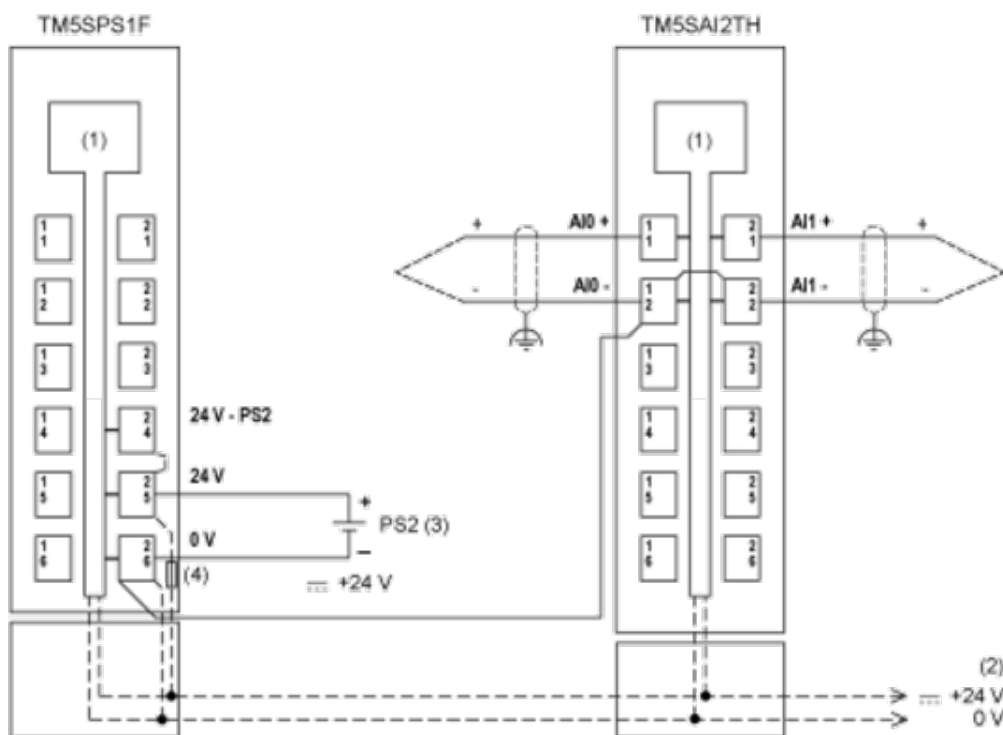

- (1) Internal electronics
- (2) 24 Vdc I/O power segment integrated into the bus bases
- (3) PS2: External isolated SELV power supply 24 Vdc limited to 200 VA for UL508 conformance, or limited to 150 VA for CSA 22.2, N° 142 conformance
- (4) Integrated fuse type T slow-blow 6.3 A 250 V exchangeable