

Productinformatieblad

Specificaties

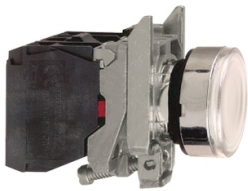

Druknop, Verlicht, Verzonken, Terugvering, Ø22mm, 250V, 1NO + 1NC, Wit

XB4BW3165

EAN Code: 3389110887303

Prijs: 29,00 EUR

Hoofd

range of product	Harmony XB4
product or component type	Verlichte drukknoop
device short name	XB4
kraag materiaal	Verchroomd metaal
materiaal bevestigingskraag	Zamak
bevestigingsdiameter	22,5 mm
verkoop per ondeelbare hoeveelheid	1
koptype	Standaard
vorm van kop signaleringseenheid	Rond
type operator	terugverend
operator profiel	Wit verzonken
extra informatie operator	Met gewone lens
type en samenstelling contacten	1 NO + 1 NC
werking contacten	Slow-break
aansluitingen - aansluitklemmen	Schroefklem aansluitingen, $\leq 2 \times 1,5 \text{ mm}^2$ met kabeluiteinde conform aan IEC 60947-1 Schroefklem aansluitingen, $1 \times 0,22...2 \times 2,5 \text{ mm}^2$ zonder kabeluiteinde conform aan IEC 60947-1
lichtbron	Lamp niet inbegrepen
lamp fitting	BA 9s
voeding lichtblok	Rechtstreeks $<2,4 \text{ W}$
Us nominale voedingsspanning	$\leq 250 \text{ V}$

Complementair

height	47 mm
width	30 mm
depth	57 mm
beschrijving klemmen ISO n°1	(21-22)NC (13-14)NO
net weight	0,097 kg
weerstand hoge druk drukkring	7000000 Pa bij 55 °C, afstand: 0.1 m
contact gebruik	Standaardcontacten

De weergegeven prijs is de adviesprijs in euro excl. BTW. Deze kan onderhevig zijn aan korting. Neem contact op met uw lokale distributeur of detailhandel voor de daadwerkelijke prijs

positieve opening	Met conform aan IEC 60947-5-1 appendix K
bedrijfstraject	1,5 mm (normaal gesloten elektrische status wijzigen) 2,6 mm (normaal open elektrische status wijzigen) 4,3 mm (totale reis)
bedieningskracht	3,5 N normaal gesloten elektrische status wijzigen 3,8 N
mechanical durability	10000000 cycles
aandraaimoment	0,8...1,2 N.m conform aan IEC 60947-1
vorm schroefkop	Kruis compatibel met kruis nr. 1 schroevendraaier Kruis compatibel met pozidriv Nr. 1 schroevendraaier Gegroefd compatibel met vlak Ø 4 mm schroevendraaier Gegroefd compatibel met vlak Ø 5,5 mm schroevendraaier
contact materiaal	Zilverlegering (Ag/Ni)
kortsluitbeveiliging	10 A smeltpatroon type gG conform aan IEC 60947-5-1
lth conventionele thermische stroom in vrije lucht	10 A conform aan IEC 60947-5-1
Ui nom isolatiespanning	600 V (vervuilingsgraad 3) conform aan IEC 60947-1
Uimp nom. schokgolfspanning	6 kV conform aan IEC 60947-1
le nom. bedrijfstrom	3 A bij 240 V, AC-15, A600 conform aan IEC 60947-5-1 6 A bij 120 V, AC-15, A600 conform aan IEC 60947-5-1 0,1 A bij 600 V, DC-13, Q600 conform aan IEC 60947-5-1 0,27 A bij 250 V, DC-13, Q600 conform aan IEC 60947-5-1 0,55 A bij 125 V, DC-13, Q600 conform aan IEC 60947-5-1 1,2 A bij 600 V, AC-15, A600 conform aan IEC 60947-5-1
elektrische levensduur	1000000 cycles, AC-15, 2 A bij 230 V, gebruiksnelheid <3600 cyc/h, belastingsfactor: 0,5 conform aan IEC 60947-5-1 appendix C 1000000 cycles, AC-15, 3 A bij 120 V, gebruiksnelheid <3600 cyc/h, belastingsfactor: 0,5 conform aan IEC 60947-5-1 appendix C 1000000 cycles, AC-15, 4 A bij 24 V, gebruiksnelheid <3600 cyc/h, belastingsfactor: 0,5 conform aan IEC 60947-5-1 appendix C 1000000 cycles, DC-13, 0,2 A bij 110 V, gebruiksnelheid <3600 cyc/h, belastingsfactor: 0,5 conform aan IEC 60947-5-1 appendix C 1000000 cycles, DC-13, 0,5 A bij 24 V, gebruiksnelheid <3600 cyc/h, belastingsfactor: 0,5 conform aan IEC 60947-5-1 appendix C
elektrische betrouwbaarheid	$\Lambda < 10^{\exp(-6)}$ bij 5 V en 1 mA in propeere omgeving conform aan IEC 60947-5-4 $\Lambda < 10^{\exp(-8)}$ bij 17 V en 5 mA in propeere omgeving conform aan IEC 60947-5-4
type signalering	Vast
product presentatie	Compleet product

Omgeving

beschermende behandeling	TH
ambient air temperature for storage	-40...70 °C
ambient air temperature for operation	-40...55 °C
beschermingsklasse tegen elektrische schokken	Klasse I conforming to IEC 60536
IP beschermingsgraad	IP66 conform aan IEC 60529 IP67 IP69 IP69K
NEMA beschermingsgraad	NEMA 13 NEMA 4X
IK-beschermingsgraad	IK06 conforming to IEC 50102

standards	CSA C22.2 Nr 14 IEC 60947-5-1 JIS C8201-5-1 IEC 60947-1 IEC 60947-5-4 IEC 60947-5-5 UL 508 JIS C8201-1
product certifications	CSA LROS (Lloyds register of shipping) BV UL listed DNV
trilling bestendigheid	5 gn (f= 2...500 Hz) conforming to IEC 60068-2-6
schokbestendigheid	30 gn (duur = 18 ms) voor halve sinusgolf versnelling conform aan IEC 60068-2-27 50 gn (duur = 11 ms) voor halve sinusgolf versnelling conform aan IEC 60068-2-27

Verpakkingseenheid

Unit Type of Package 1	PCE
Number of Units in Package 1	1
Package 1 Height	3,500 cm
Package 1 Width	5,500 cm
Package 1 Length	8,500 cm
Package 1 Weight	96,700 g
Unit Type of Package 2	S02
Number of Units in Package 2	55
Package 2 Height	15,000 cm
Package 2 Width	30,000 cm
Package 2 Length	40,000 cm
Package 2 Weight	5,576 kg
Unit Type of Package 3	P06
Number of Units in Package 3	880
Package 3 Height	75,000 cm
Package 3 Width	80,000 cm
Package 3 Length	60,000 cm
Package 3 Weight	97,208 kg

contractuele waarborg

Garantie	18 months
-----------------	-----------

Environmental Data

Schneider Electric wil tegen 2050 de Net Zero-status hebben bereikt via partnerschappen in de toeleveringsketen, materialen met een lagere impact en circulariteit via onze doorlopende campagne "Use Better, Use Longer, Use Again" om de levensduur van producten en de recycleerbaarheid te verlengen.

[Uitleg van Environmental Data >](#)

[Hoe evalueren we de duurzaamheid van producten? >](#)

Milieuvoetafdruk

Totale levenscyclus ecologische voetafdruk 31

Milieuprofiel van product (PEP) [Milieuprofiel van het product](#)

Use Better

Materialen en verpakking

Pakket met gerecycleerd karton Ja

Verpakkingen zonder kunststof Ja

[EU-richtlijn RoHS](#) Voldoet pro-actief (Product valt niet onder de EU RoHS juridische scope)

SCIP-nummer 425812e5-011f-4fb4-ad1b-fc9cf9865300

REACH-regelgeving [REACH-verklaring](#)

Use Again

Herverpakken en herfabriceren

Circulair Profiel [Informatie over einde levensduur](#)

Terugname No

WEEE Label  Het product moet op markten van de Europese Unie worden afgevoerd volgens specifieke afvalinzamelingsregels en mag nooit in een gewone vuilnisbak terechtkomen.

Dimensions Drawings

Dimensions

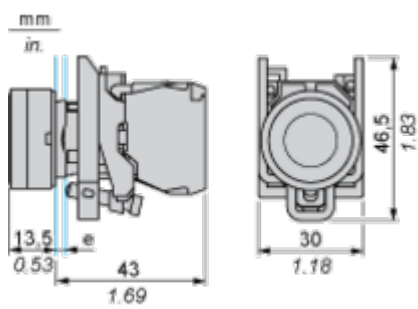

e : clamping thickness: 1 to 6 mm / 0.04 to 0.24 in.

Mounting and Clearance

Panel Cut-out for Pushbuttons, Switches and Pilot Lights (Finished Holes, Ready for Installation)

Connection by Screw Clamp Terminals or Plug-in Connectors or on Printed Circuit Board	Connection by Faston Connectors
	
<p>(1) Diameter on finished panel or support</p> <p>(2) 40 mm min. / 1.57 in. min.</p> <p>(3) 30 mm min. / 1.18 in. min.</p> <p>(4) $\varnothing 22.5 \text{ mm} / 0.89 \text{ in.}$ recommended ($\varnothing 22.3 \text{ mm} \begin{smallmatrix} +0.4 \\ 0 \end{smallmatrix} / 0.88 \text{ in.} \begin{smallmatrix} +0.016 \\ 0 \end{smallmatrix}$)</p> <p>(5) 45 mm min. / 1.78 in. min.</p> <p>(6) 32 mm min. / 1.26 in. min.</p>	

Technical Illustration

Dimensions

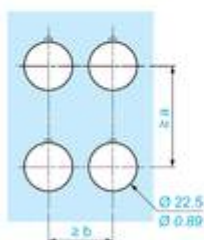
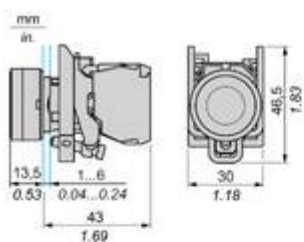

		a (mm)	a (in.)	b (mm)	b (in.)
		40	1.57	30	1.18
ZBE.....	ZBV.....				
		45	1.77	32	1.26
ZBE.....3	ZBV.....3				
		40	1.57	30	1.18
ZBE.....4	ZBV.....4				
		50	1.97	30	1.18
ZBE.....5	ZBV.....5				
		40	1.57	30	1.18
ZBE.....9	ZBV.....9				
		40	1.57	30	1.18
ZBRT•	ZBRV1				

Offer Marketing Illustration

Product benefits / Features

Features
Harmony XB4/XB5 Illuminated functions

NEW universal LED Block for all colors

Simple stock management

Improved installation time and easy selection





Improved color intensity and brightness

The image features a green background with the title 'Features' and subtitle 'Harmony XB4/XB5 Illuminated functions'. It displays four key benefits, each with a circular icon and a corresponding photograph of the product. The benefits are: 1. 'NEW universal LED Block for all colors' with a square icon containing a smaller square; 2. 'Simple stock management' with an icon of a person holding a clipboard; 3. 'Improved installation time and easy selection' with a circular arrow icon; 4. 'Improved color intensity and brightness' with a sun icon. The product images show various colored buttons (green, red, yellow) and their internal LED components.

Offer Marketing Illustration

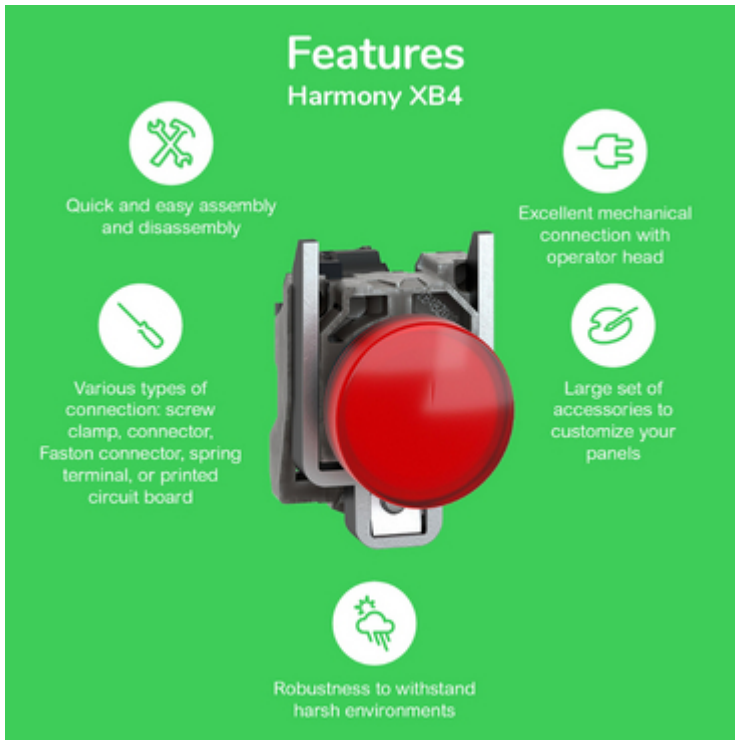
Product benefits / Features

Features
Harmony XB4

-  Quick and easy assembly and disassembly
-  Excellent mechanical connection with operator head
-  Various types of connection: screw clamp, connector, Faston connector, spring terminal, or printed circuit board
-  Large set of accessories to customize your panels
-  Robustness to withstand harsh environments

Offer Marketing Illustration

Product benefits / Features

Technical Benefits

Harmony XB4

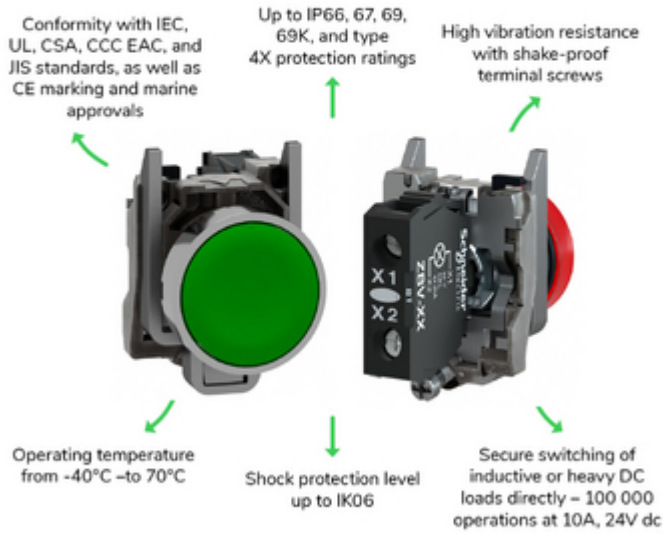

Image of product / Alternate images

Alternative

