

6LE090737A

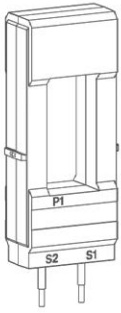

- (DE)
- (EN)
- (FR)
- (NL)
- (PL)

Installationsanweisung

Stromwandler

Installation instruction, [see page 4](#)

Current transformer

Consignes relatives aux actions à effectuer lors de d'installation, [voir page 7](#)

Transformateur de courant

Installatie-instructie, [zie pagina 10](#)

Stroomtransformator

Installatie-instructie, [patrz strona 13](#)

Przekładnik prądowy

CT 1000

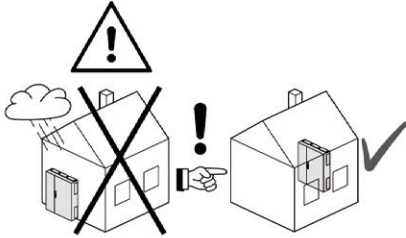

	Bemessungs- Primär- / Se- kundärstrom	Bemessungs- leistung	Bemessungs- Genauigkeits- klasse
LV8ZW1000	1000A / 5A	5 VA	Klasse 1
LV8ZW1000K05S	1000A / 5A	2,5 VA	Klasse 0.5S
LV8ZW1000K05SG	1000A / 5A	2,5 VA	Klasse 0.5S
LV8ZW1000K05SK	1000A / 5A	2,5 VA	Klasse 0.5S

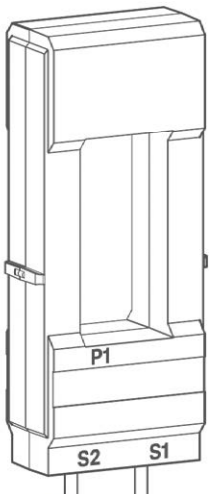

LV8ZW1000
LV8ZW1000K05S
LV8ZW1000K05SG
LV8ZW1000K05SK

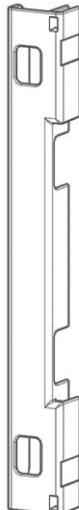

LVZKH

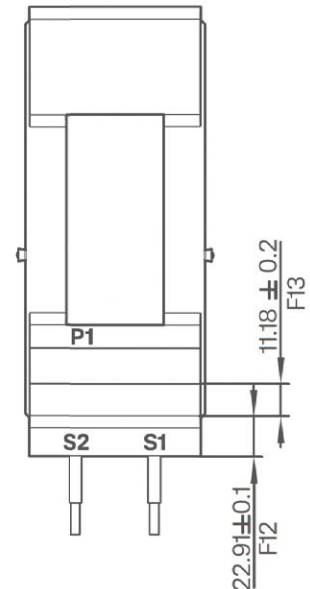

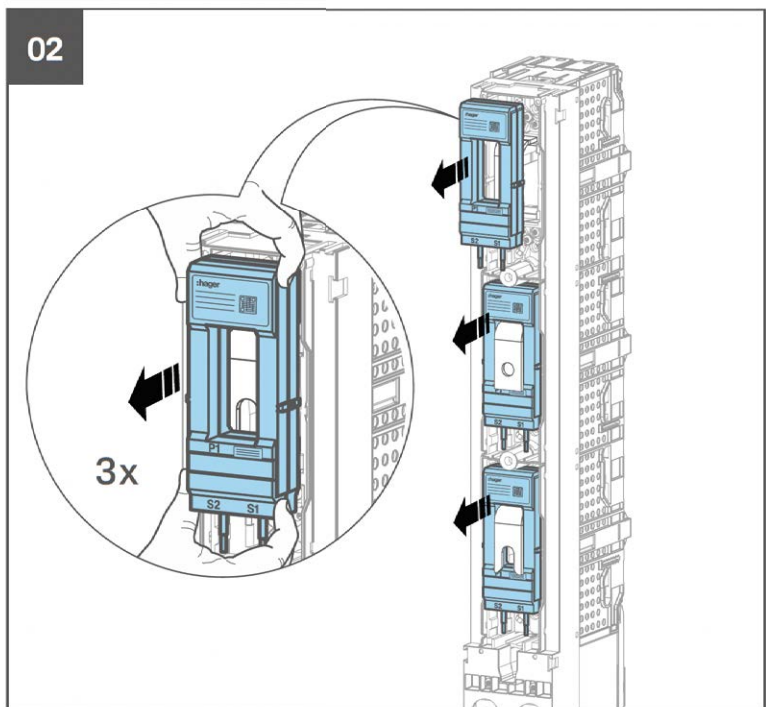
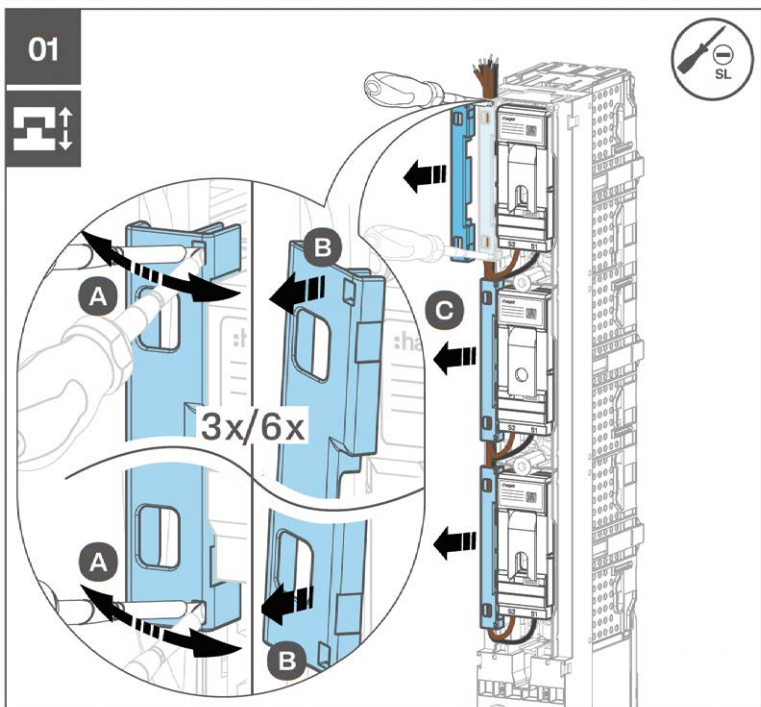
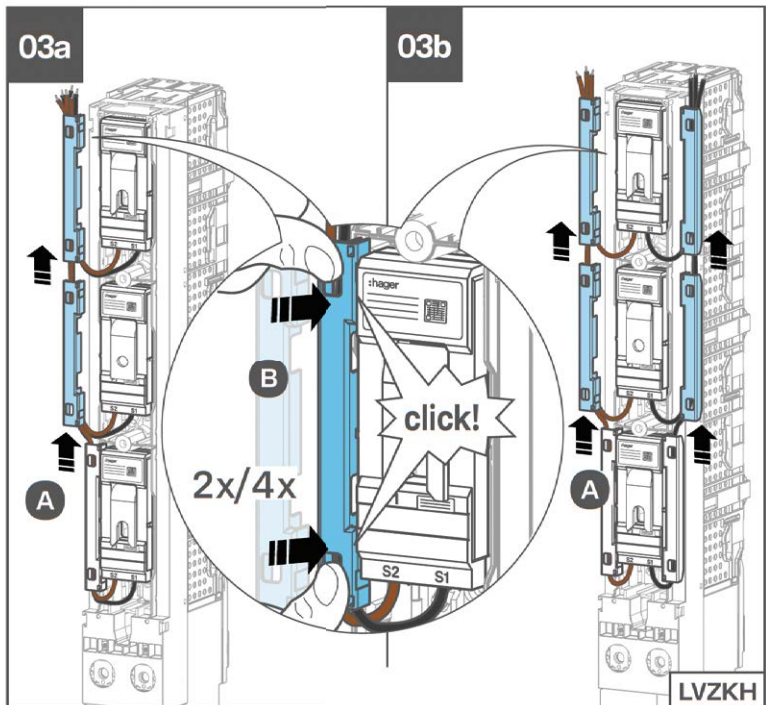
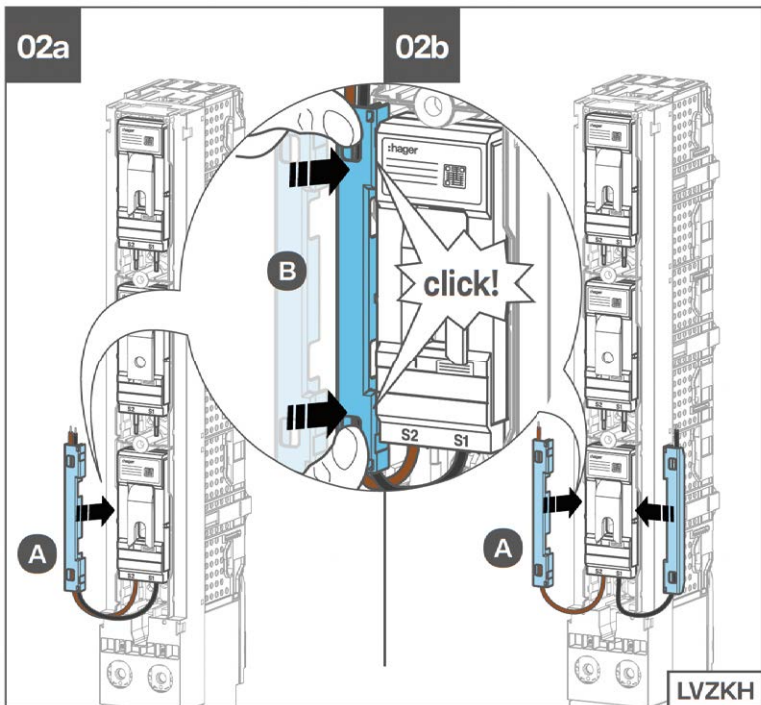
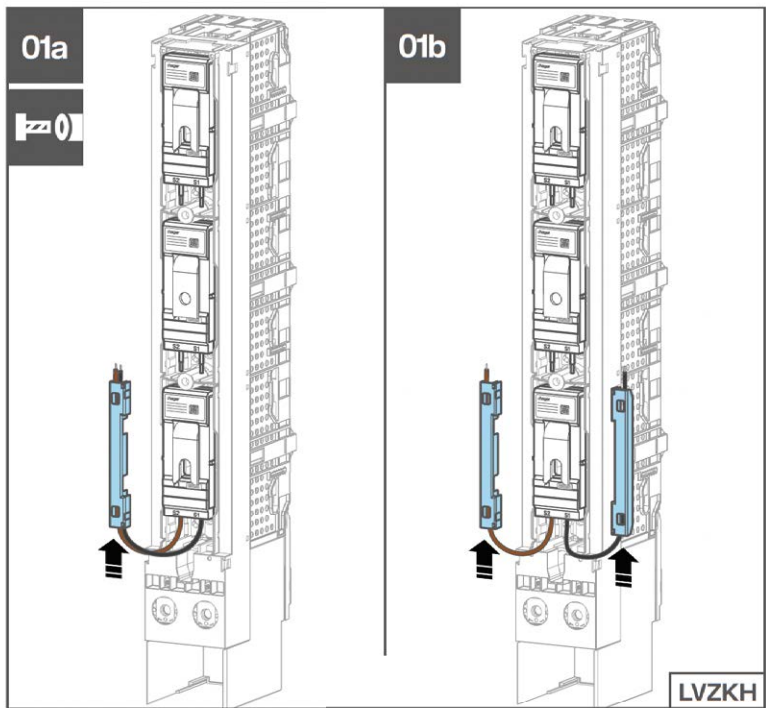
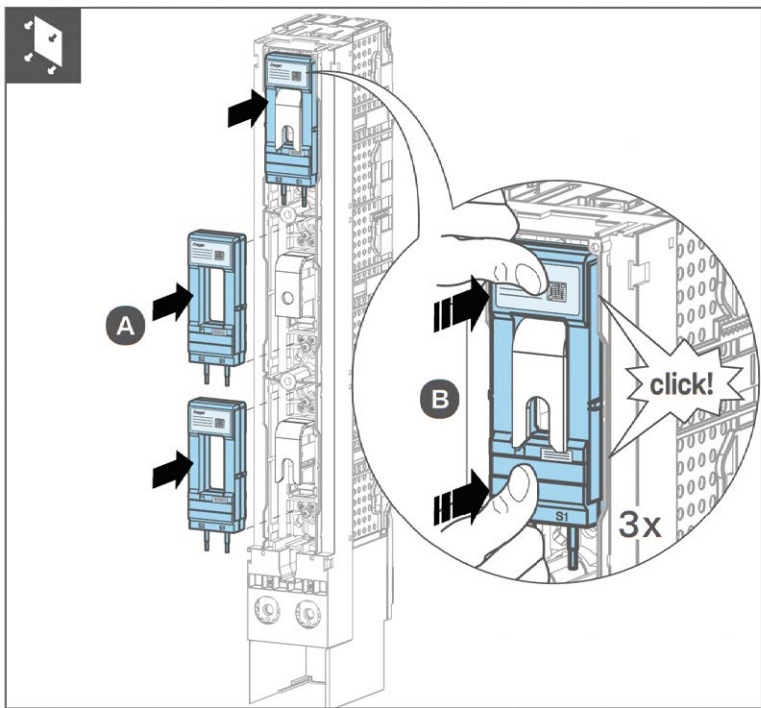

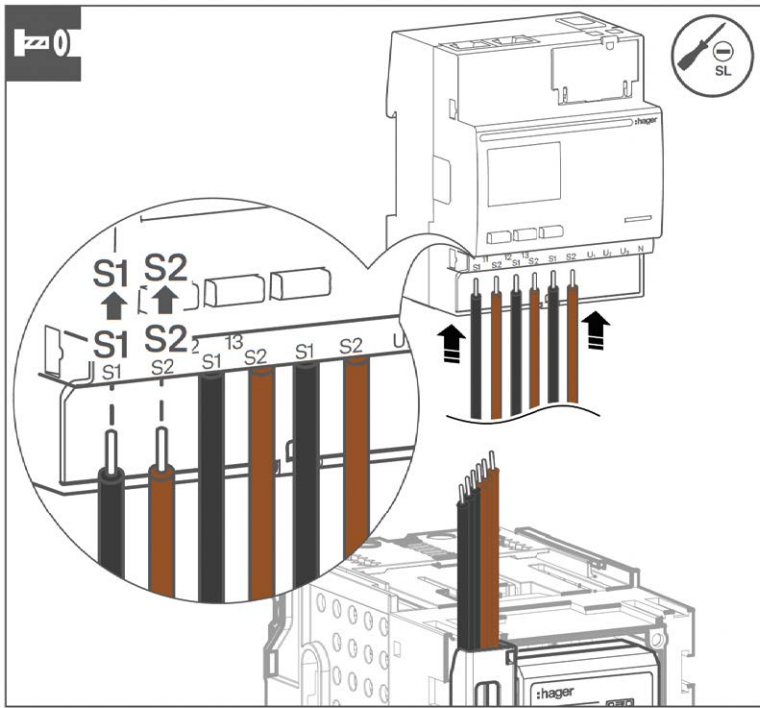

DE

Hager-kompatible Referenzen mit dem CT:

ECR300C	ECA300C	ECM300C
ECR301C	ECA301C	ECM301C
ECR302C	ECA302C	ECM302C
ECP300C	SM101C	
ECP301C	SM101E	
ECP302C	SM102E	
	SM103E	



Wenn kein Messgerät angeschlossen ist, sollten die sekundären Klemmleisten kurzgeschlossen werden.

Grundlegende Kriterien zur Einhaltung der CT-Kompatibilität:

- Der Primär-/Sekundärstrom des CT muss dem Bemessungsstrom des Messgeräts entsprechen. Dies ist in der Regel der Fall, wenn Standardwerte verwendet werden und das Gerät häufig über einen großen Strombereich programmierbar ist.
- Die Bemessungslast [VA] eines Stromwandlers (CT) muss größer sein als die kombinierte Leistungsaufnahme von Messgerät und Anschlusskabel. Das Messgerät stimmt im Allgemeinen mit dem CT-Ausgang [VA] überein. Für genaue Messungen sollte diese gesamte Leistungsaufnahme jedoch auch innerhalb eines bestimmten Bereichs liegen:



$$S_r \geq S_{\text{Kabel}} + S_{\text{Meter}} \geq 1/4 S_r \text{ (aber min. 1 VA)}$$

S_r = Bemessungsleistung[VA]
 $S_{\text{Kabel}}^{(1)}$ = Leistungsbedarf des Kabels
 S_{Meter} = Leistungsbedarf des Messgeräts

⁽¹⁾ S_{Kabel} ist immer das zusätzliche Kabel, das vom Installationstechniker hinzugefügt wird. Die Leistungsaufnahme sollte von den sekundären Klemmleisten des CT oder vom Ende der daran angeschlossenen ortsfesten Kabel berücksichtigt werden.

Leistungsbedarf zweidräger Kabel für CT (Sekundärstrom von 5 A)

Leiterquerschnitt	Leistungsbedarf [VA] je nach Kabellänge [m]									
	1 m	2 m	30 m	30 m	30 m	30 m	30 m	30 m	30 m	30 m
1,5 mm ²	0,6	1,19	2,38	2,38	4,76	4,76	8,93	11,90	11,90	23,81
2,5 mm ²	0,36	0,71	1,43	2,14	2,86	3,57	5,36	7,14	10,71	14,29
4 mm ²	0,22	0,45	0,89	1,34	1,79	2,23	3,35	4,46	6,7	8,93
6 mm ²	0,15	0,30	0,60	0,89	1,19	1,49	2,23	2,98	4,46	5,95
10 mm ²	0,09	0,18	0,36	0,54	0,71	0,89	1,34	1,79	2,68	3,57

6LE090737A

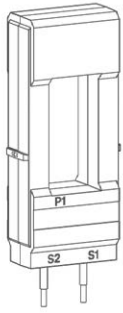

- Ⓛ DE
- Ⓛ EN
- Ⓛ FR
- Ⓛ NL
- Ⓛ PL

Installationsanweisung, [siehe Seite 1](#)

Stromwandler

Installation instruction

Current transformer

Consignes relatives aux actions à effectuer lors de d'installation, [voir page 7](#)

Transformateur de courant

Installatie-instructie, [zie pagina 10](#)

Stroomtransformator

Installatie-instructie, [patrz strona 13](#)

Przekładnik prądowy

CT 1000

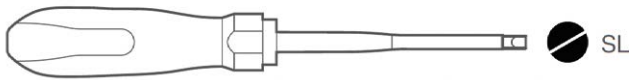
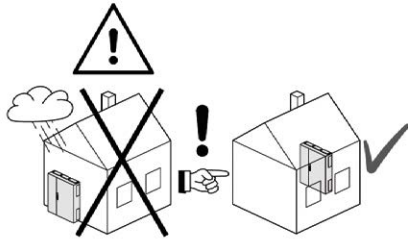

	Rated primary / secondary current	Rated Output	Rated accuracy class
LV8ZW1000	1000 A / 5 A	5 VA	class 1
LV8ZW1000K05S	1000 A / 5 A	2.5 VA	class 0.5S
LV8ZW1000K05SG	1000 A / 5 A	2.5 VA	class 0.5S
LV8ZW1000K05SK	1000 A / 5 A	2.5 VA	class 0.5S

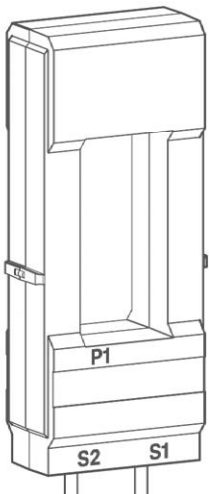

LV8ZW1000
LV8ZW1000K05S
LV8ZW1000K05SG
LV8ZW1000K05SK

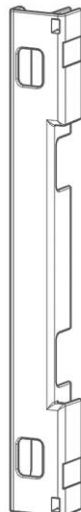

LVZKH

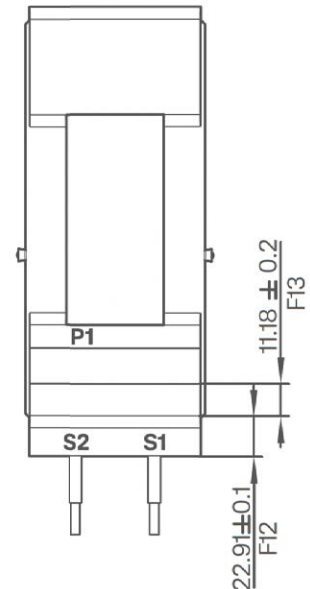

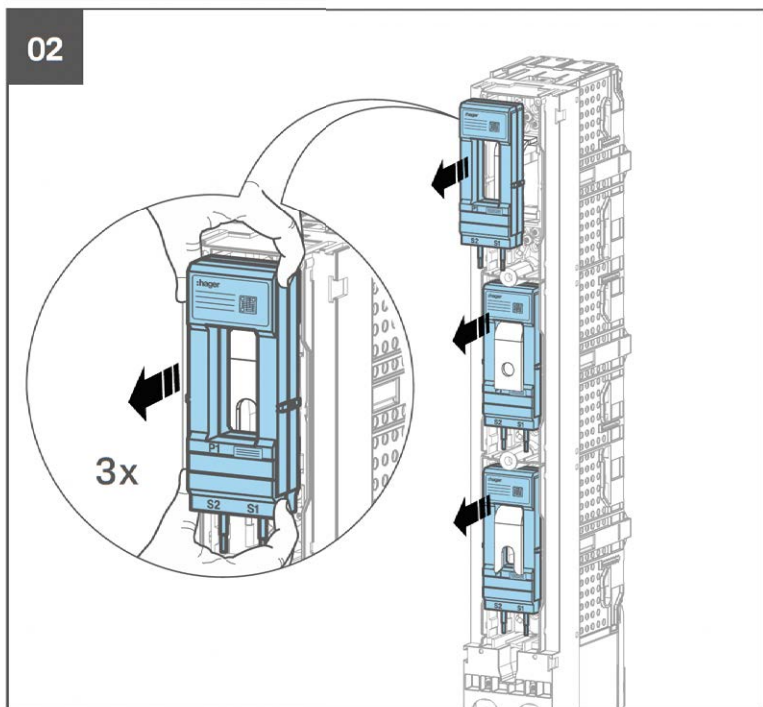
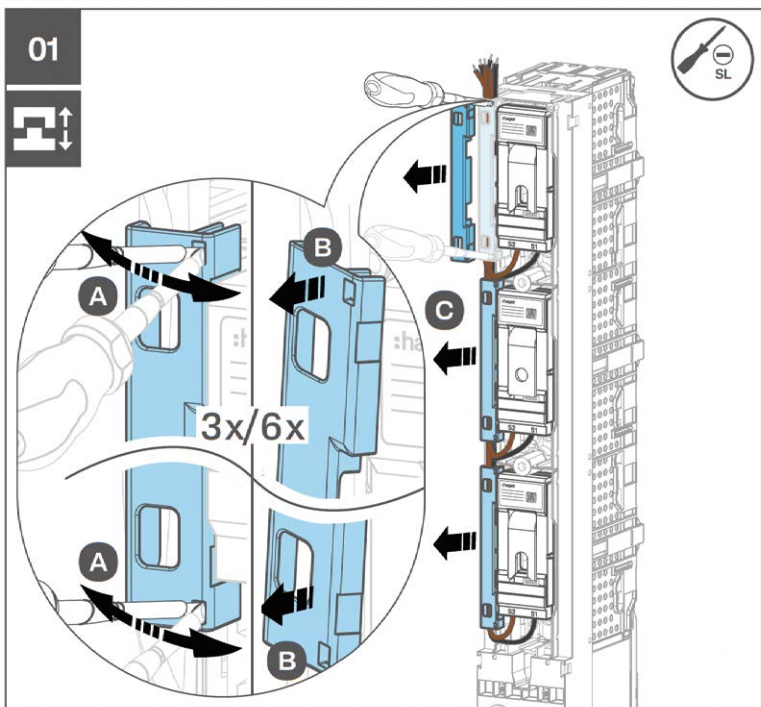
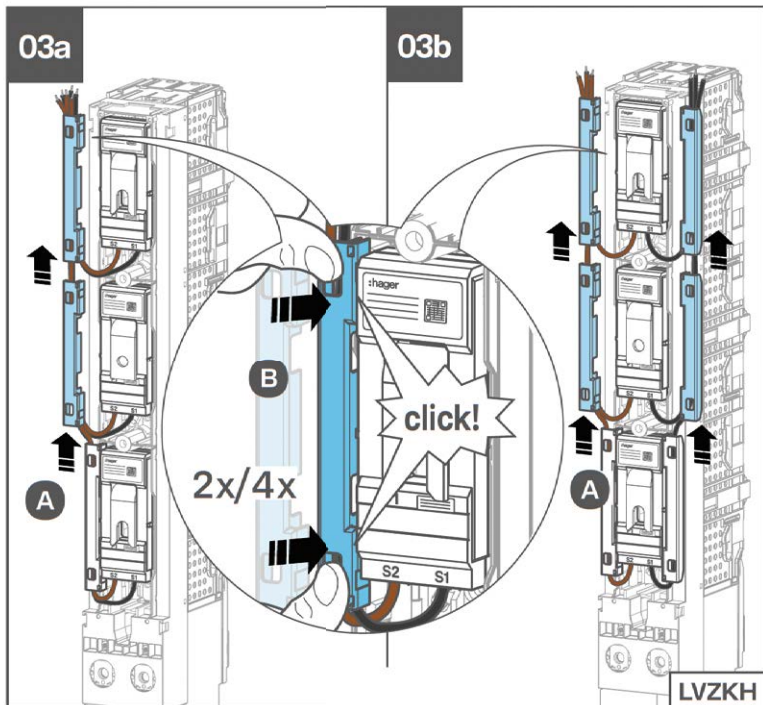
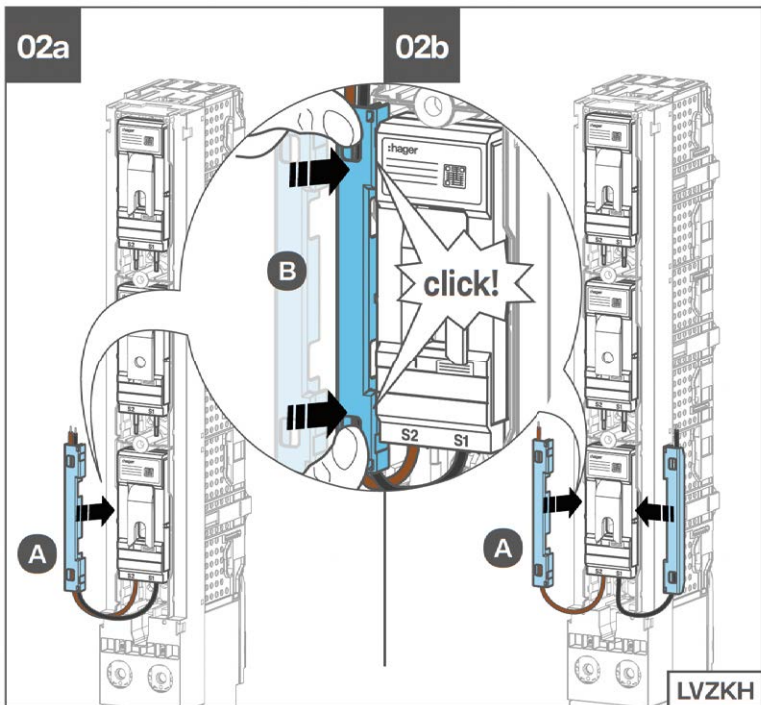
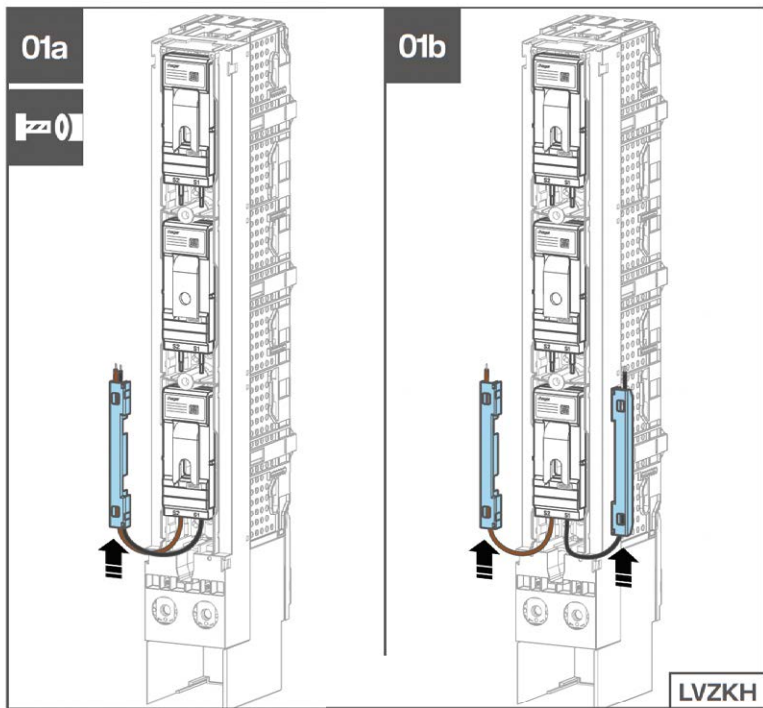
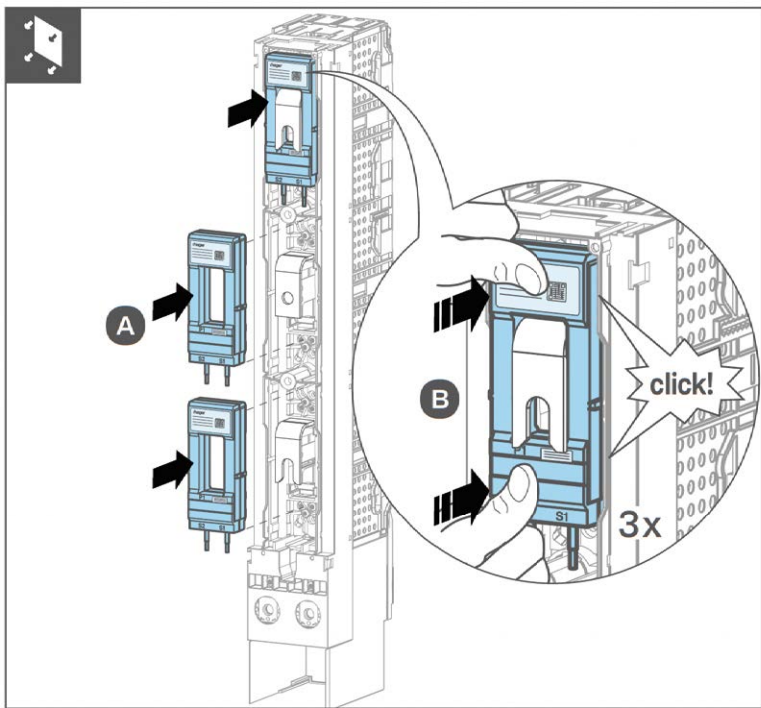

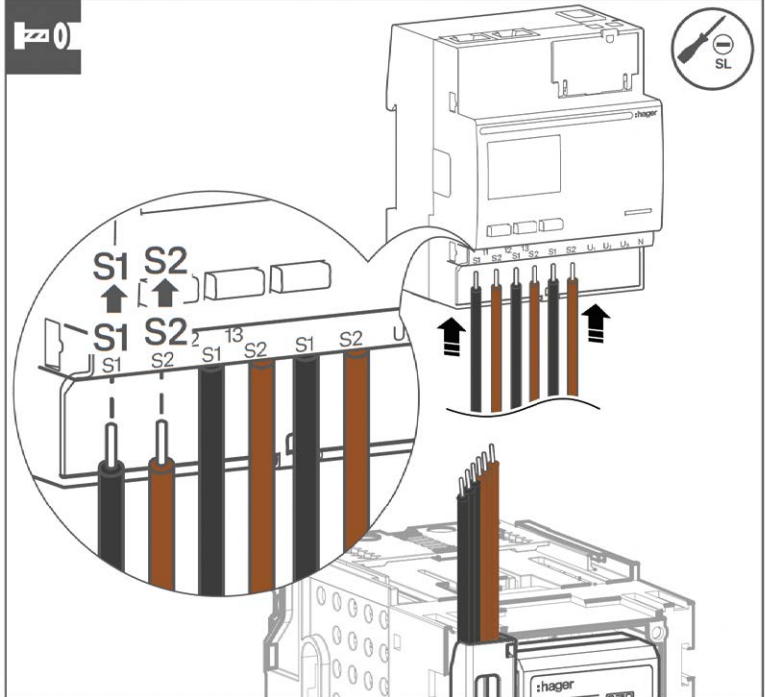

EN

Hager compatible references with the CT:

ECR300C	ECA300C	ECM300C
ECR301C	ECA301C	ECM301C
ECR302C	ECA302C	ECM302C
ECP300C	SM101C	
ECP301C	SM101E	
ECP302C	SM102E	
	SM103E	

⚠ If no meter is connected secondary terminals should be short circuited.

Basic criteria to respect for CT compatibility:

- The primary/ secondary current of the CT must match the rated current of the measurement device. This is usually the case, if standard values are used and the device is often programmable across a wide current range.
- The rated burden [VA] of a current transformer (CT) must be greater than the combined power consumption of the measurement device and the connecting cable. The measurement device generally match with the CT output [VA]. However, for accurate measurements, this total power consumption should also be within a specific range:

⚠

$$S_r \geq S_{cable} + S_{meter} \geq 1/4 S_r \text{ (but 1 VA min)}$$

S_r = rated output [VA]
 $S_{cable}^{(1)}$ = power demand of the cable
 S_{meter} = power demand of the measurement device

⁽¹⁾ S_{cable} is always the additional cable added by the installer.
 The power consumption should be considered from the CT's secondary terminals or from the end of the fixed cables connected to them.

Power demand of two-core cables for CT (secondary current of 5A)

Conductor cross-section	Power demand [VA] depending on cable length [m]										
	1m	2m	4m	6m	8m	10m	15m	20m	30m	40m	
1,5 mm ²	0,6	1,19	2,38	2,38	4,76	4,76	8,93	11,90	11,90	23,81	
2,5 mm ²	0,36	0,71	1,43	2,14	2,86	3,57	5,36	7,14	10,71	14,29	
4 mm ²	0,22	0,45	0,89	1,34	1,79	2,23	3,35	4,46	6,7	8,93	
6 mm ²	0,15	0,30	0,60	0,89	1,19	1,49	2,23	2,98	4,46	5,95	
10 mm ²	0,09	0,18	0,36	0,54	0,71	0,89	1,34	1,79	2,68	3,57	

6LE090737A

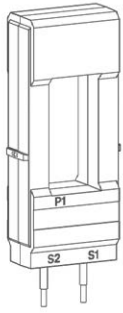

(DE)

(EN)

(FR)

(NL)

(PL)

Installationsanweisung, [siehe Seite 1](#)

Stromwandler

Installation instruction, [see page 4](#)

Current transformer

Consignes relatives aux actions à effectuer lors de d'installation

Transformateur de courant

Installatie-instructie, [zie pagina 10](#)

Stroomtransformator

Installatie-instructie, [patrz strona 13](#)

Przekładnik prądowy

CT 1000

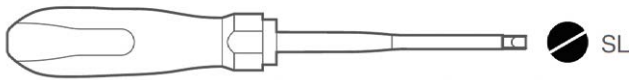

	Courant secondaire assigné	Puissance de sortie assignée	Classe de précision nominale
LV8ZW1000	1000 A / 5 A	5 VA	Class 1
LV8ZW1000K05S	1000 A / 5 A	2,5 VA	Classe 0.5S
LV8ZW1000K05SG	1000 A / 5 A	2,5 VA	Classe 0.5S
LV8ZW1000K05SK	1000 A / 5 A	2,5 VA	Classe 0.5S

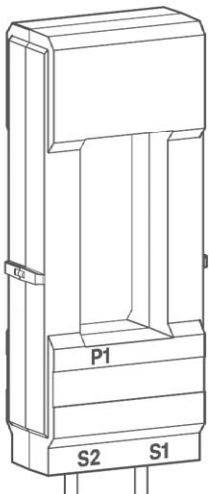

LV8ZW1000
LV8ZW1000K05S
LV8ZW1000K05SG
LV8ZW1000K05SK

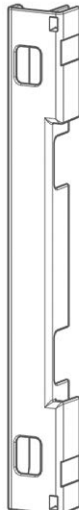

LVZKH

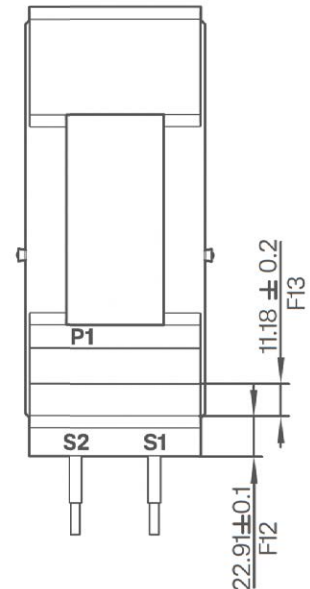

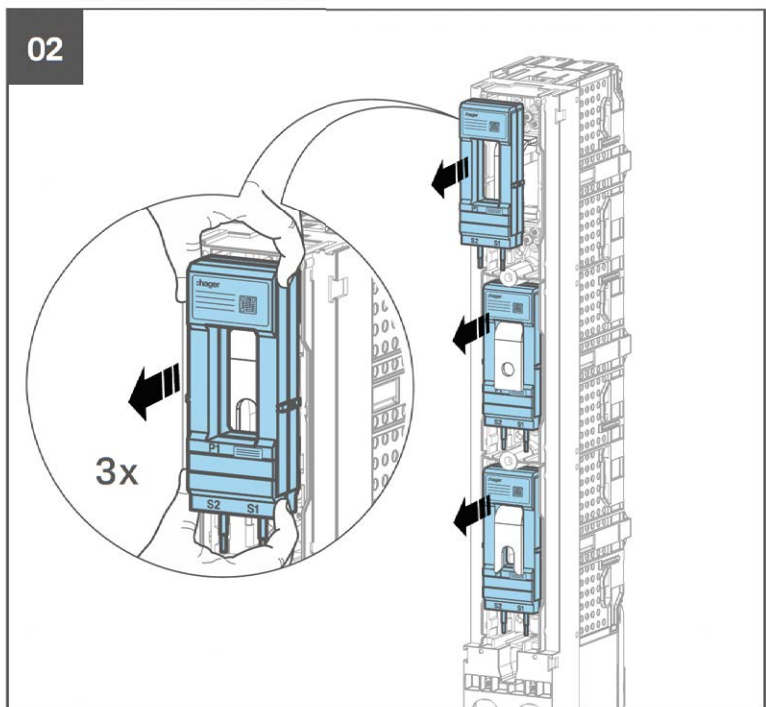
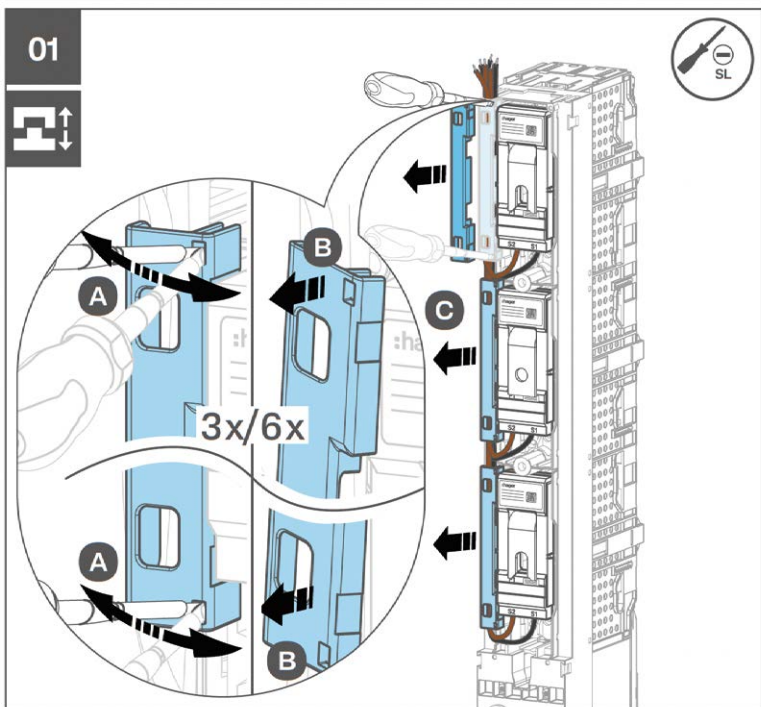
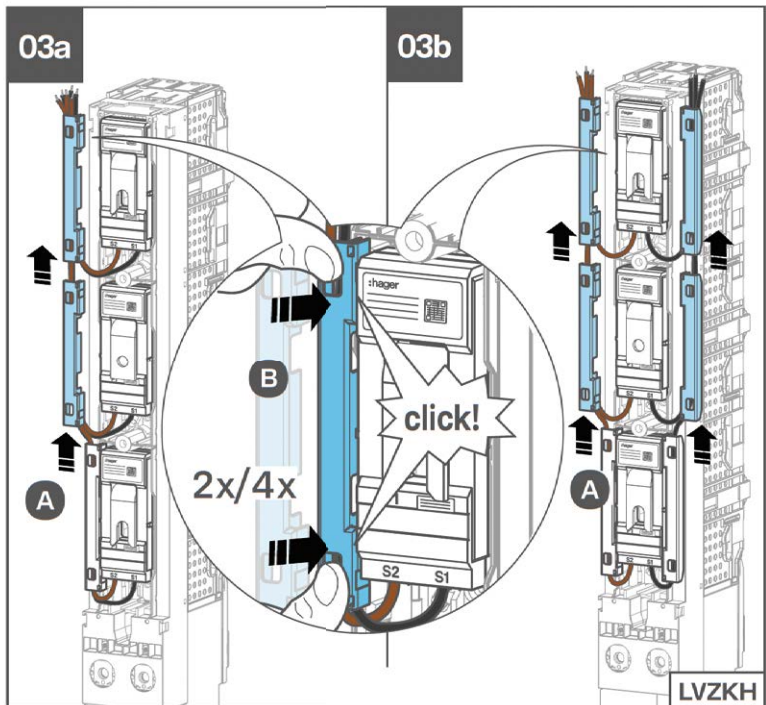
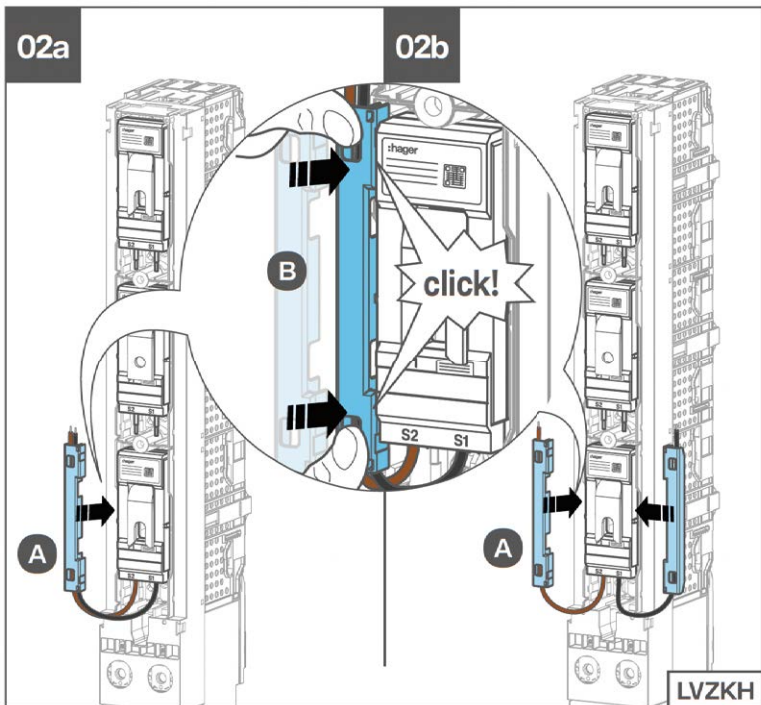
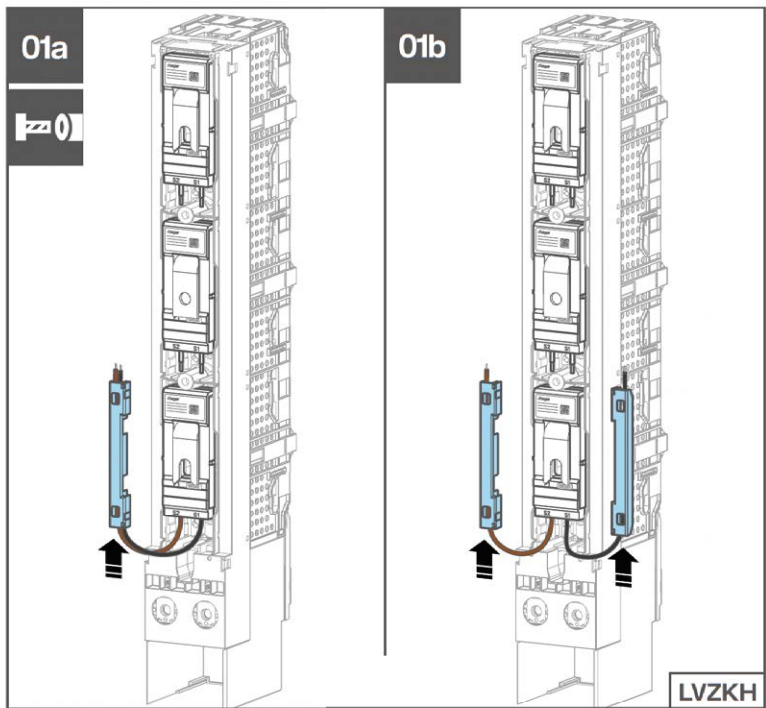
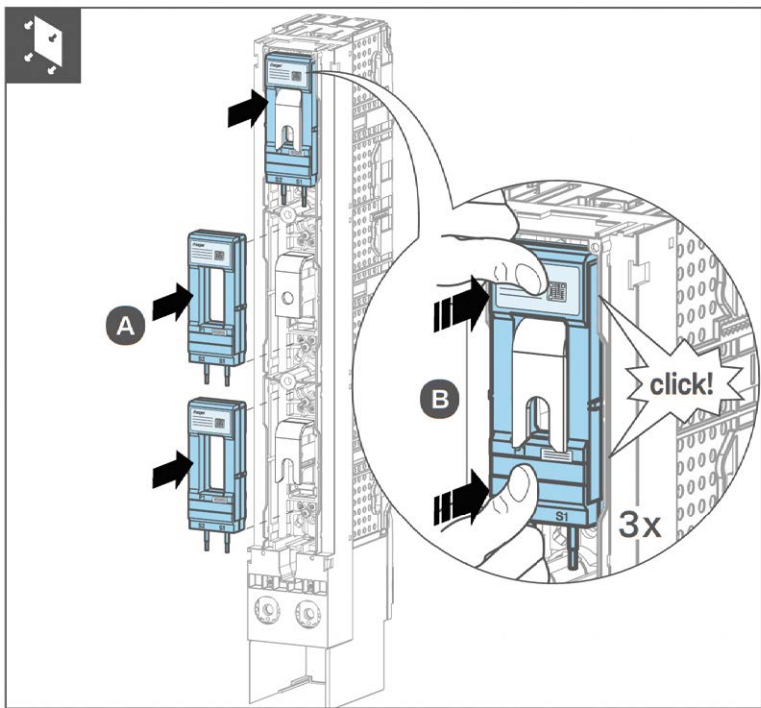

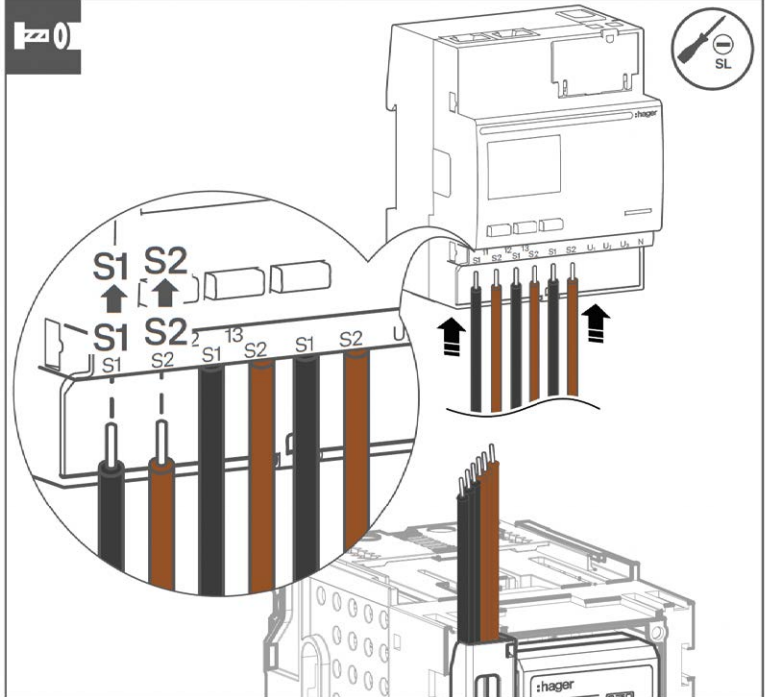

(FR)

Références Hager compatibles avec le TC :

ECR300C	ECA300C	ECM300C
ECR301C	ECA301C	ECM301C
ECR302C	ECA302C	ECM302C
ECP300C	SM101C	
ECP301C	SM101E	
ECP302C	SM102E	
	SM103E	

⚠ Si aucun multimètre n'est connecté, les bornes secondaires doivent être court-circuitées.

Critères de base à respecter pour la compatibilité avec le TC :

- Le courant primaire/secondaire du TC doit correspondre au courant nominal de l'appareil de mesure. C'est généralement le cas, si des valeurs standard sont utilisées et que le dispositif est souvent programmable sur une large plage de courant.
- La charge nominale [VA] d'un transformateur de courant (TC) doit être supérieure à la consommation électrique combinée de l'appareil de mesure et du câble de raccordement. Le dispositif de mesure correspond généralement à la sortie du TC [VA].

Cependant, pour des mesures précises, cette consommation électrique totale doit également se situer dans une plage spécifique :

$S_r \geq S_{\text{câble}} + S_{\text{multimètre}} \geq 1/4 S_r$ (mais 1 VA min.)

S_r = puissance nominale [VA]

$S_{\text{câble}}$ ⁽¹⁾ = puissance requise du câble

$S_{\text{multimètre}}$ = puissance requise de l'appareil de mesure

⁽¹⁾ $S_{\text{câble}}$ est toujours le câble supplémentaire ajouté par l'installateur. La consommation électrique doit être prise en compte à partir des bornes secondaires du TC ou à partir de l'extrémité des câbles fixes qui y sont connectés.

Charge requise des câbles à deux conducteurs pour TC (courant secondaire de 5 A)

Section du conducteur	Charge requise[VA] en fonction de la longueur du câble [m]										
	1 m	2 m	4 m	6 m	8 m	10 m	15 m	20 m	30 m	40 m	
1,5 mm ²	0,6	1,19	2,38	2,38	4,76	4,76	8,93	11,90	11,90	23,81	
2,5 mm ²	0,36	0,71	1,43	2,14	2,86	3,57	5,36	7,14	10,71	14,29	
4 mm ²	0,22	0,45	0,89	1,34	1,79	2,23	3,35	4,46	6,7	8,93	
6 mm ²	0,15	0,30	0,60	0,89	1,19	1,49	2,23	2,98	4,46	5,95	
10 mm ²	0,09	0,18	0,36	0,54	0,71	0,89	1,34	1,79	2,68	3,57	

6LE090737A

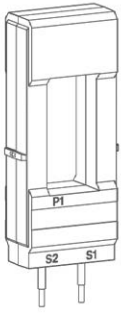

- Ⓛ DE
- Ⓛ EN
- Ⓛ FR
- Ⓛ NL
- Ⓛ PL

Installationsanweisung, [siehe Seite 1](#)

Stromwandler

Installation instruction, [see page 4](#)

Current transformer

Consignes relatives aux actions à effectuer lors de d'installation, [voir page 7](#)

Transformateur de courant

Installatie-instructie

Stroomtransformator

Installatie-instructie, [patrz strona 13](#)

Przekładnik prądowy

CT 1000

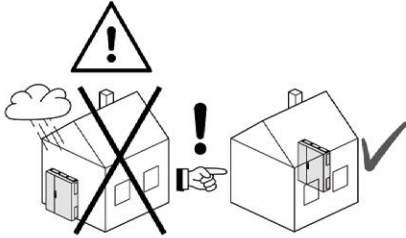

	Nominale primaire / secondaire stroom	Nominaal Uitgang	Nominale nauwkeurig- heidsklasse
LV8ZW1000	1000 A / 5 A	5 VA	klasse 1
LV8ZW1000K05S	1000 A / 5 A	2,5 VA	Klasse 0.5S
LV8ZW1000K05SG	1000 A / 5 A	2,5 VA	Klasse 0.5S
LV8ZW1000K05SK	1000 A / 5 A	2,5 VA	Klasse 0.5S

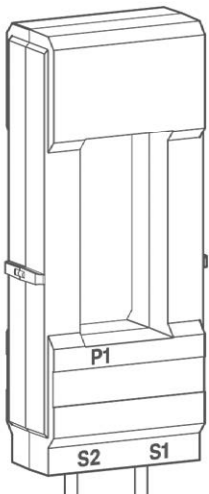

LV8ZW1000
LV8ZW1000K05S
LV8ZW1000K05SG
LV8ZW1000K05SK

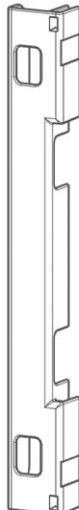

LVZKH

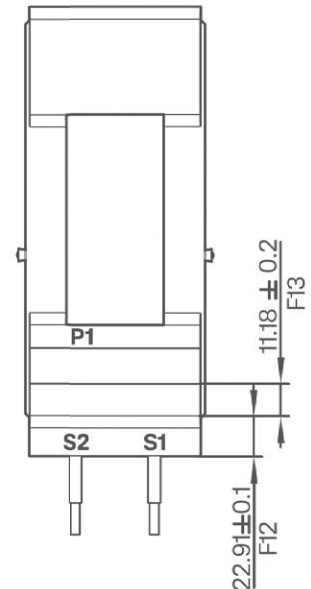

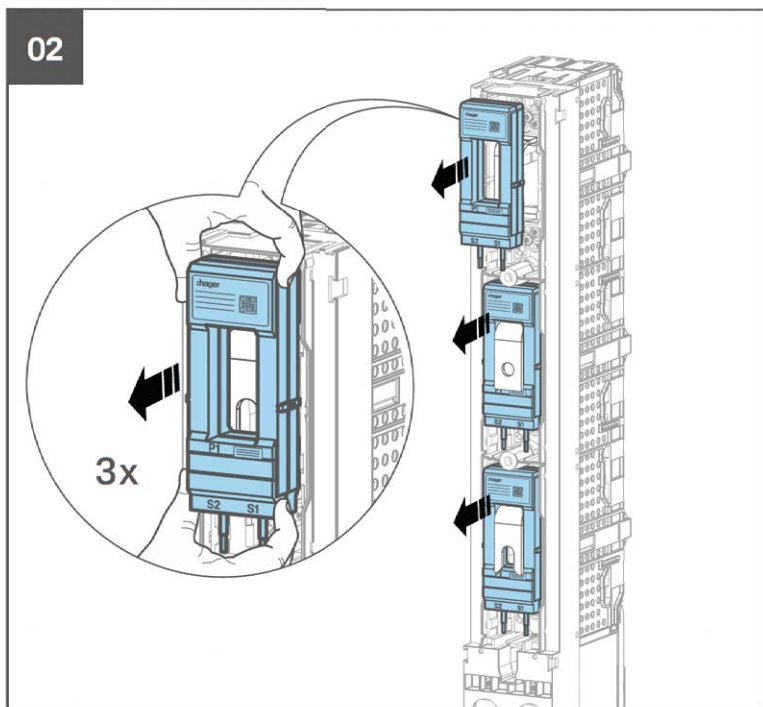
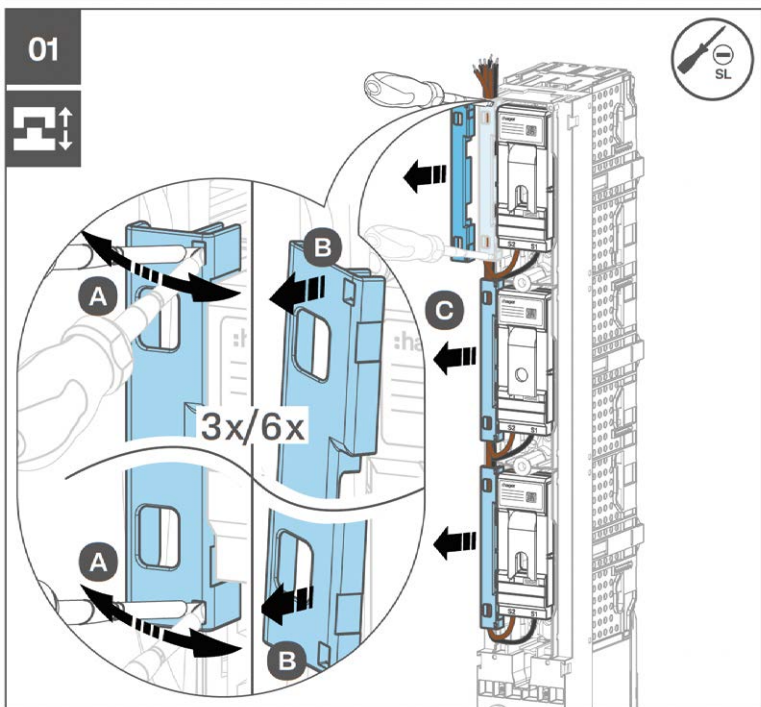
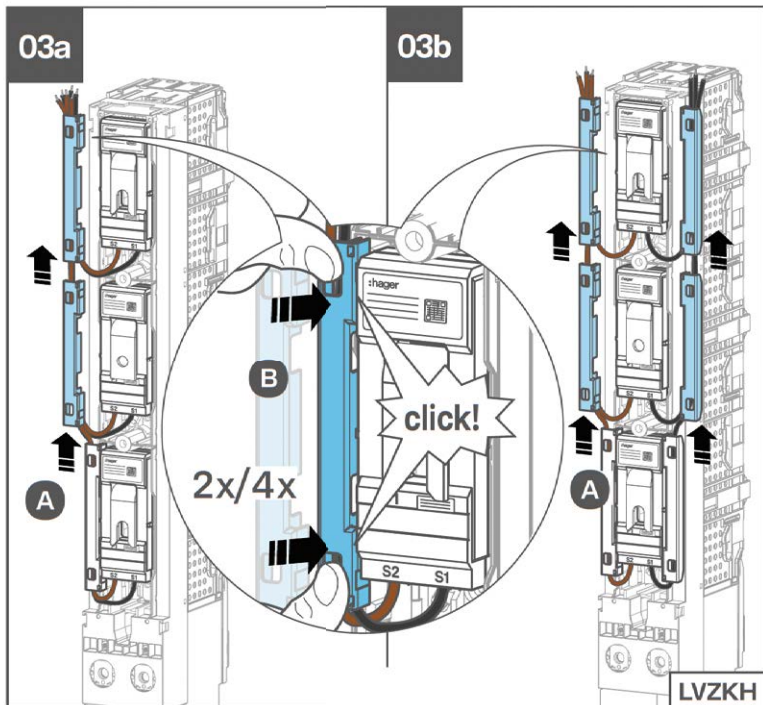
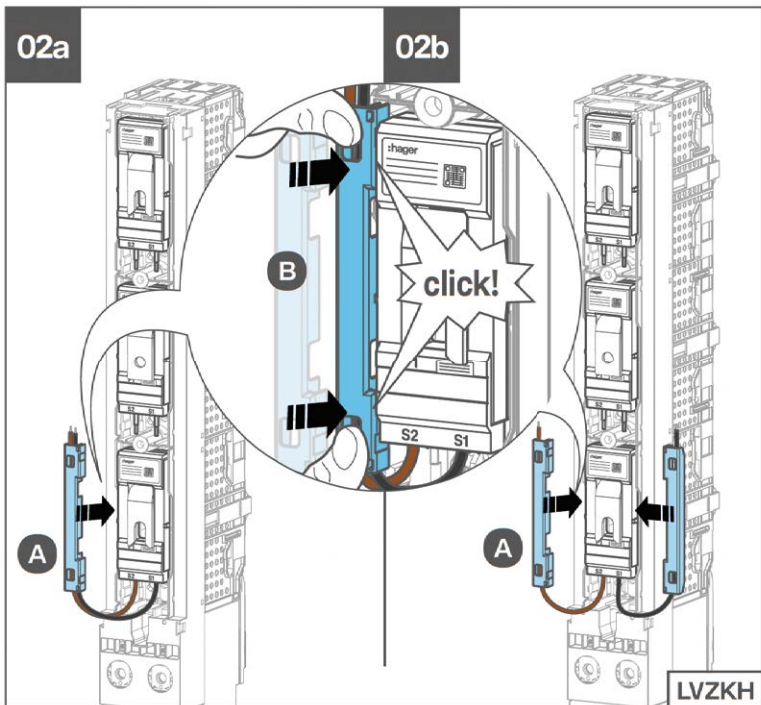
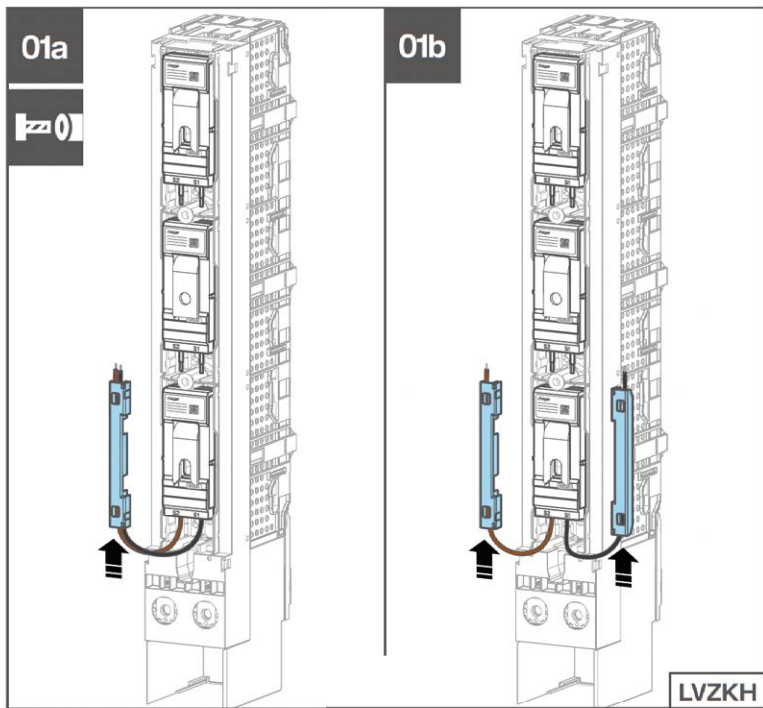
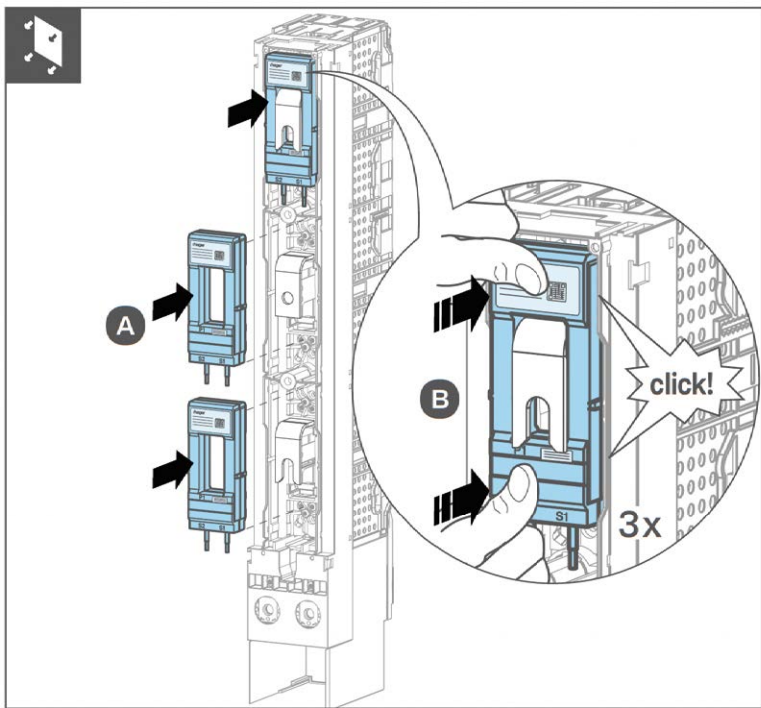

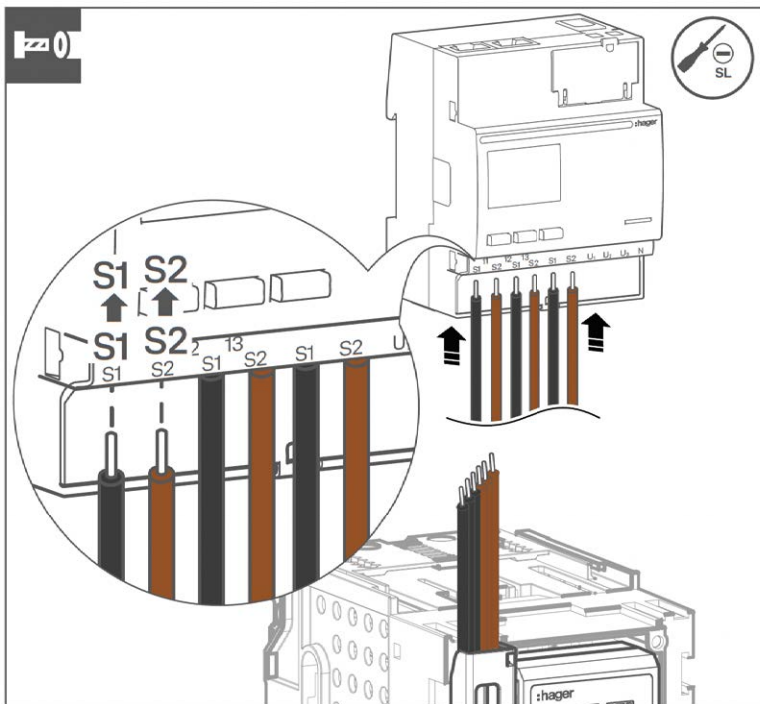

(NL)

Compatibele producten met de stroomtransformatoren van Hager:

ECR300C	ECA300C	ECM300C
ECR301C	ECA301C	ECM301C
ECR302C	ECA302C	ECM302C
ECP300C	SM101C	
ECP301C	SM101E	
ECP302C	SM102E	
	SM103E	



Als er geen meter is aangesloten, moeten de secundaire klemmen worden kortgesloten.

Basiscriteria voor stroomtransformator-compatibiliteit:

- De primaire/secundaire stroom van de stroomtransformator moet overeenkomen met de nominale stroom van het meetapparaat. Dit is meestal het geval als er standaardwaarden worden gebruikt en het apparaat vaak programmeerbaar is over een groot stroombereik.
- De nominale belasting [VA] van een stroomtransformator (CT) moet groter zijn dan het gecombineerde energieverbruik van het meetapparaat en de aansluitkabel. Het meetapparaat komt over het algemeen overeen met de stroomtransformator-uitgang [VA].

Voor nauwkeurige metingen moet dit totale energieverbruik echter ook binnen een bepaald bereik liggen:



$$S_r \geq S_{\text{kabel}} + S_{\text{meter}} \geq 1/4 S_r \text{ (maar 1 VA min)}$$

$$S_r = \text{nominale uitgang [VA]}$$

$$S_{\text{kabel}}^{(1)} = \text{benodigd vermogen van de kabel}$$

$$S_{\text{meter}} = \text{benodigd vermogen van het meetapparaat}$$

⁽¹⁾ S_{kabel} is altijd de extra kabel die door de elektricien is toegevoegd.

Er moet rekening worden gehouden met het energieverbruik vanaf de secundaire klemmen van de stroomtransformator of vanaf het uiteinde van de vaste kabels die erop zijn aangesloten.

Benodigd vermogen van tweedraadse kabels voor stroomtransformatoren (secundaire stroom van 5 A)

Draaddoorsnede	Benodigd vermogen [VA] afhankelijk van kabellengte [m]									
	1 m	2 m	4 m	6 m	8 m	10 m	15 m	20 m	30 m	40 m
1,5 mm ²	0,6	1,19	2,38	2,38	4,76	4,76	8,93	11,90	11,90	23,81
2,5 mm ²	0,36	0,71	1,43	2,14	2,86	3,57	5,36	7,14	10,71	14,29
4 mm ²	0,22	0,45	0,89	1,34	1,79	2,23	3,35	4,46	6,7	8,93
6 mm ²	0,15	0,30	0,60	0,89	1,19	1,49	2,23	2,98	4,46	5,95
10 mm ²	0,09	0,18	0,36	0,54	0,71	0,89	1,34	1,79	2,68	3,57

6LE090737A

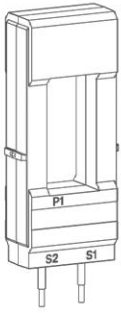

- (DE)
- (EN)
- (FR)
- (NL)
- (PL)

Installationsanweisung, [siehe Seite 1](#)
 Stromwandler
 Installation instruction, [see page 4](#)
 Current transformer
 Consignes relatives aux actions à effectuer lors de d'installation, [voir page 7](#)
 Transformateur de courant
 Installatie-instructie, [zie pagina 10](#)
 Stroomtransformator
 Installatie-instructie
 Przekładnik prądowy

CT 1000

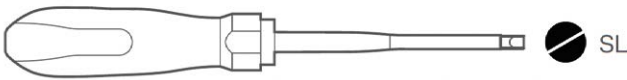

	Prąd znamionowy pierwotny / wtórny	Moc znamionowa	Znamionowa klasa dokładności
LV8ZW1000	1000 A / 5 A	5 VA	Klasa 1
LV8ZW1000K05S	1000 A / 5 A	2,5 VA	Klasa 0.5S
LV8ZW1000K05SG	1000 A / 5 A	2,5 VA	Klasa 0.5S
LV8ZW1000K05SK	1000 A / 5 A	2,5 VA	Klasa 0.5S

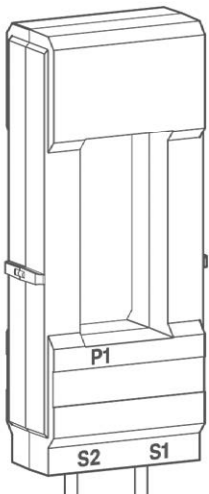

LV8ZW1000
 LV8ZW1000K05S
 LV8ZW1000K05SG
 LV8ZW1000K05SK

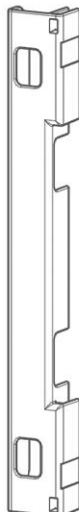

LVZKH

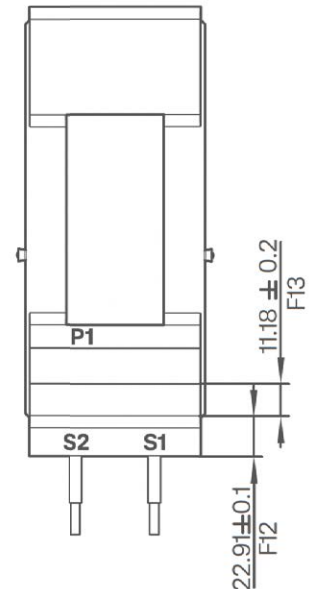

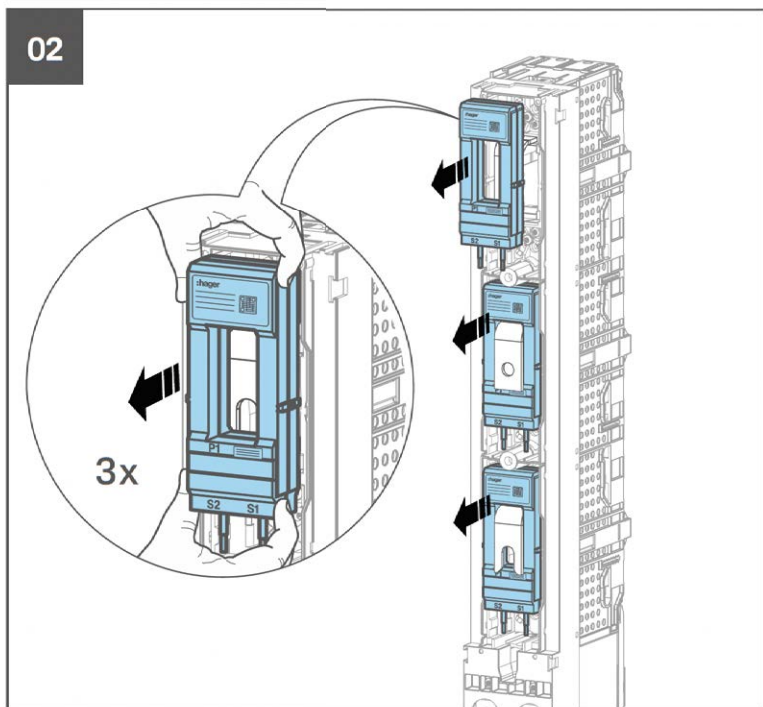
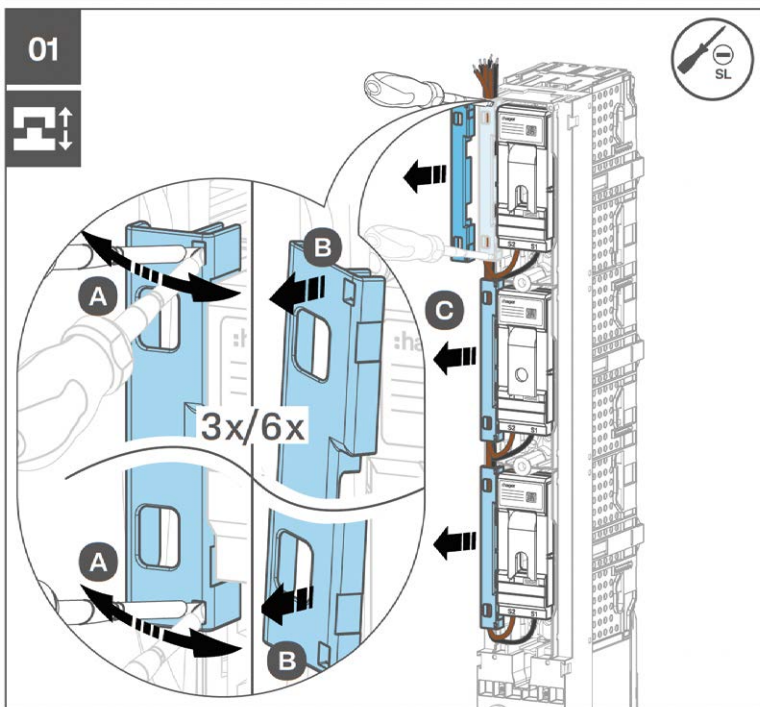
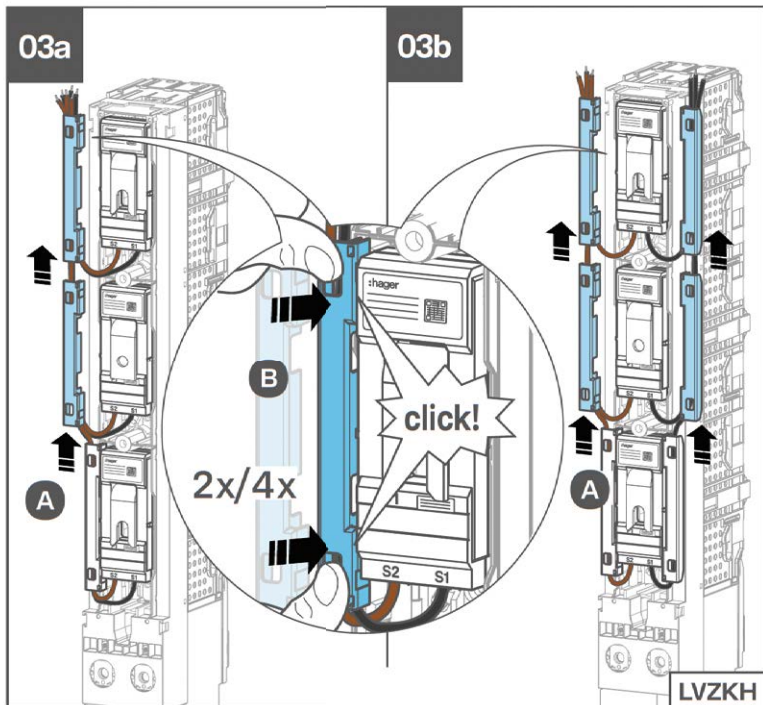
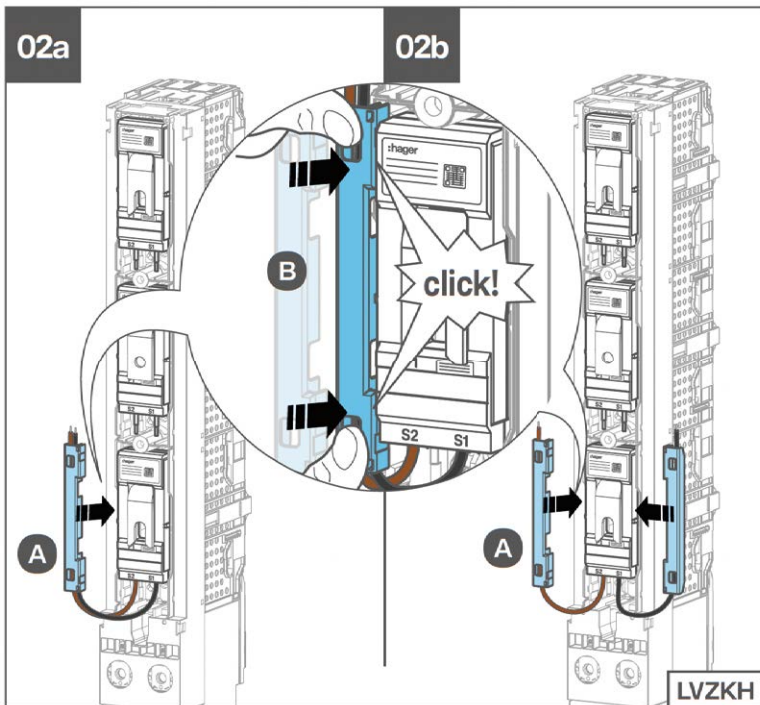
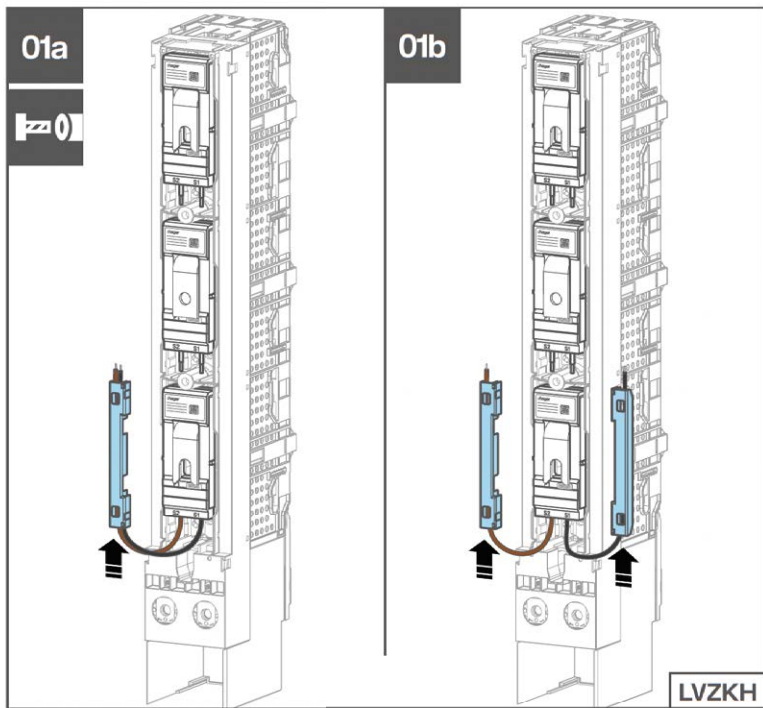
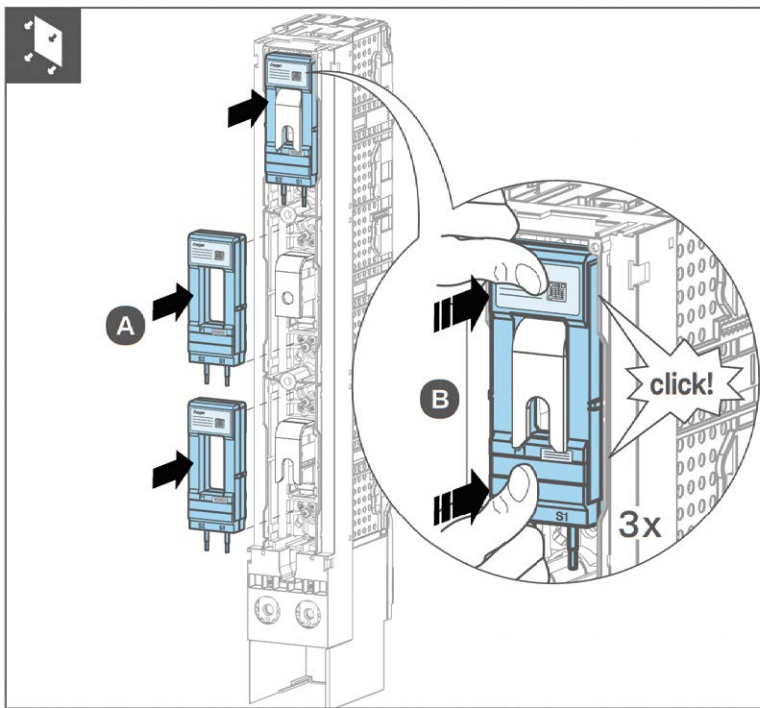

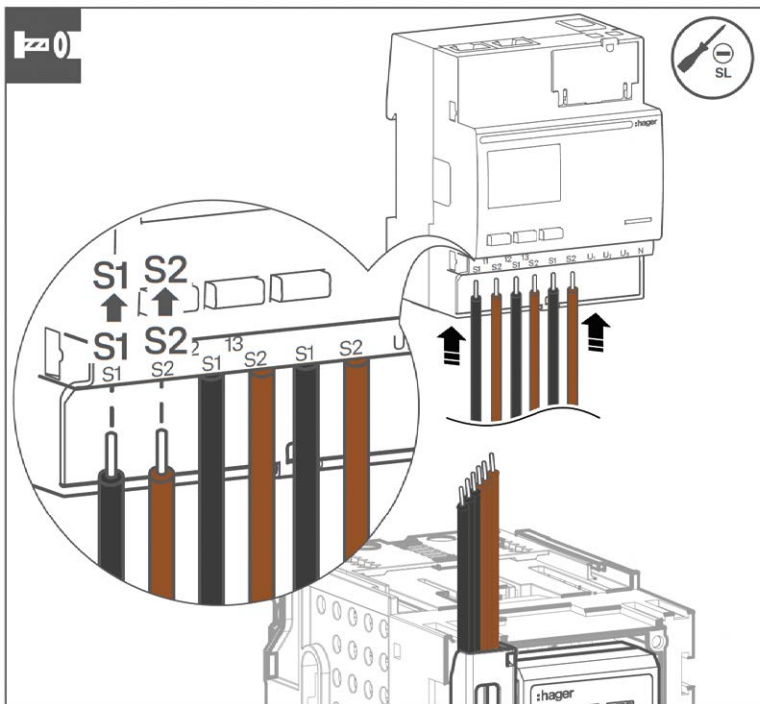

PL

Referencje urządzeń Hager kompatybilne z przekładnikami prądowym:

ECR300C	ECA300C	ECM300C
ECR301C	ECA301C	ECM301C
ECR302C	ECA302C	ECM302C
ECP300C	SM101C	
ECP301C	SM101E	
ECP302C	SM102E	
	SM103E	



Jeśli miernik nie jest podłączony, styki pomocnicze powinny być zwarte.

Podstawowe kryteria zgodności przekładnika prądowego (CT):

- Prąd pierwotny/wtórny przekładnika prądowego (CT) musi odpowiadać prądowi znamionowemu urządzenia pomiarowego. Zwykle tak jest, jeśli stosuje się wartości standardowe, a urządzenie jest często programowalne w szerokim zakresie prądów.
- Obciążenie znamionowe [VA] przekładnika prądowego (CT) musi być większe niż łączne zużycie energii przez urządzenie pomiarowe i przewód łączący. Urządzenie pomiarowe zasadniczo pasuje do mocy przekładnika prądowego [VA].

Jednak dla zapewnienia dokładnych pomiarów całkowite zużycie energii powinno również mieścić się w określonym zakresie:



$$S_r \geq S_{\text{przewód}} + S_{\text{miernik}} \geq 1/4 S_r \text{ (ale 1 VA min)}$$

$$S_r = \text{moc znamionowa [VA]}$$

$$S_{\text{przewód}}^{(1)} = \text{zapotrzebowanie na moc przewodu}$$

$$S_{\text{miernik}} = \text{zapotrzebowanie na moc urządzenia pomiarowego}$$

⁽¹⁾Przewód S jest zawsze dodatkowym przewodem montowanym przez wykwalifikowanego elektryka.

Zużycie mocy należy uwzględniać od zacisków wtórnych przekładnika prądowego lub od końców podłączonych do nich stałych przewodów.

Zapotrzebowanie na moc przewodów dwurdzeniowych do przekładnika prądowego (prąd wtórny 5 A)

Przekrój przewodu	Zapotrzebowanie na moc [VA] w zależności od długości przewodu [m]									
	1 m	2 m	4 m	6 m	8 m	10 m	15 m	20 m	30 m	40 m
1,5 mm ²	0,6	1,19	2,38	2,38	4,76	4,76	8,93	11,90	11,90	23,81
2,5 mm ²	0,36	0,71	1,43	2,14	2,86	3,57	5,36	7,14	10,71	14,29
4 mm ²	0,22	0,45	0,89	1,34	1,79	2,23	3,35	4,46	6,7	8,93
6 mm ²	0,15	0,30	0,60	0,89	1,19	1,49	2,23	2,98	4,46	5,95
10 mm ²	0,09	0,18	0,36	0,54	0,71	0,89	1,34	1,79	2,68	3,57