

# Wireless DIM & App set Flush mount

CPAD-00/221 - 300310



## Quick Installation Card

Hurtig installasjon kort - Snelle installatiekaart -  
Schnellinstallationskarte - Karta pro rychlou instalaci

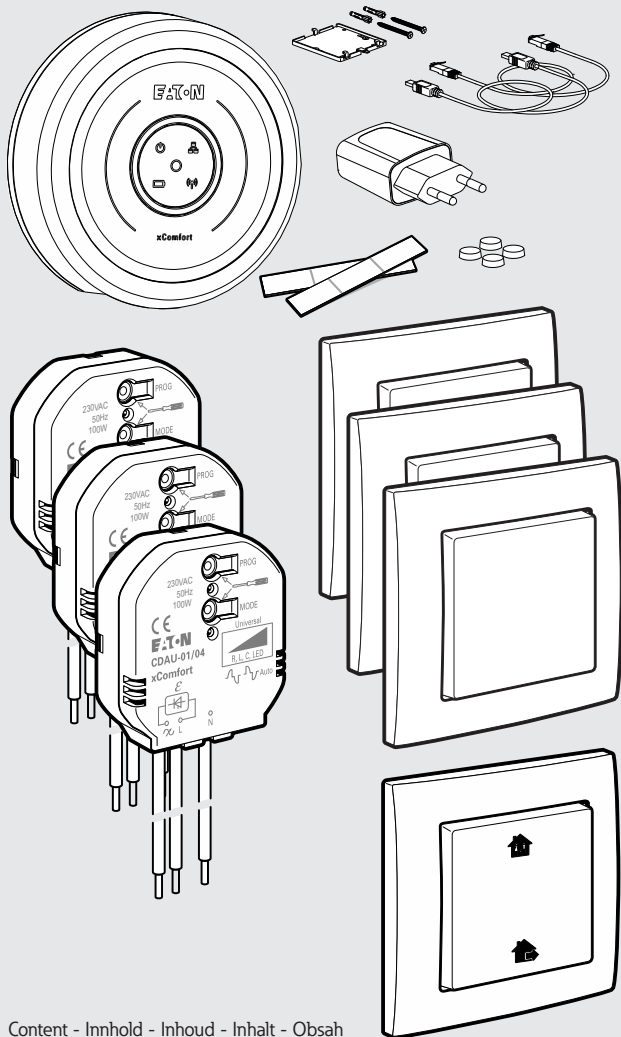

Content - Innhold - Inhoud - Inhalt - Obsah



**Pre-configured** / Pre-konfiguriert / Voorgeconfigureerd / Vorkonfiguriert / Předkonfigurováno

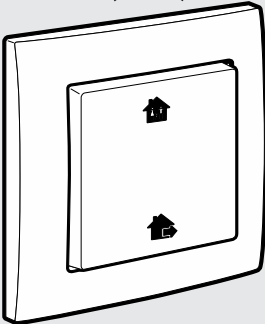
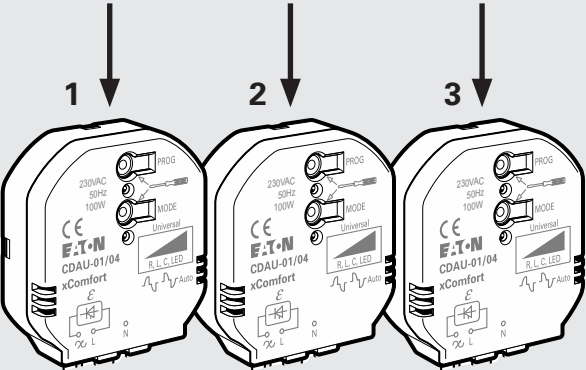
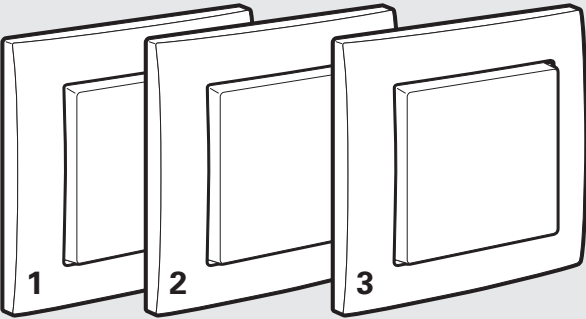



1

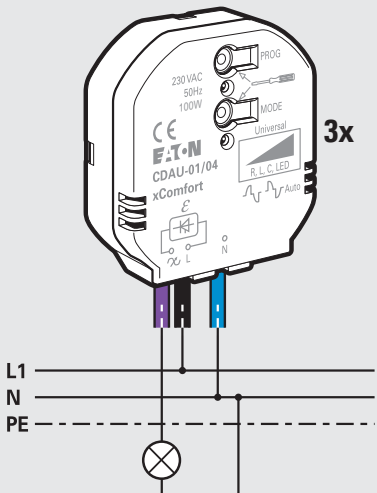

**Optional adjust dimming range**

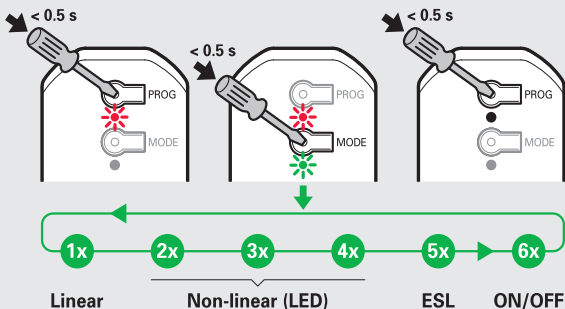

**Mounting examples**

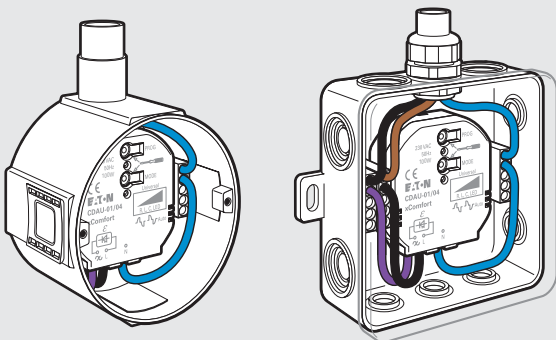

2

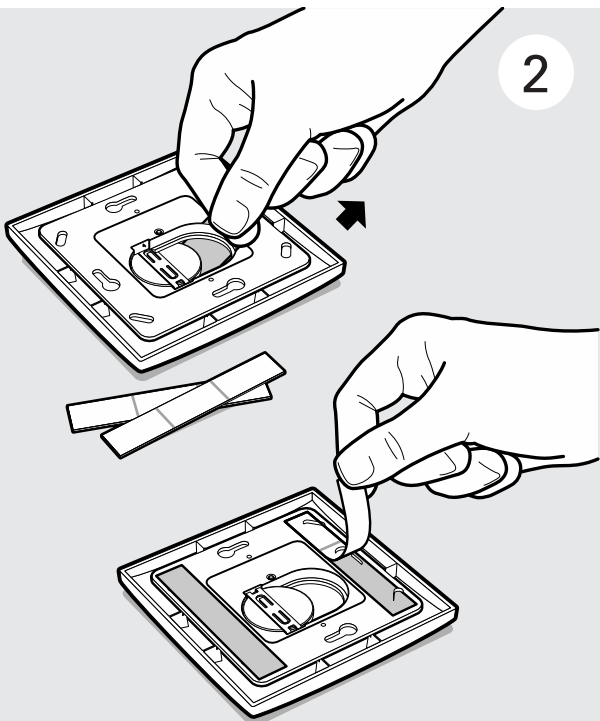

3x

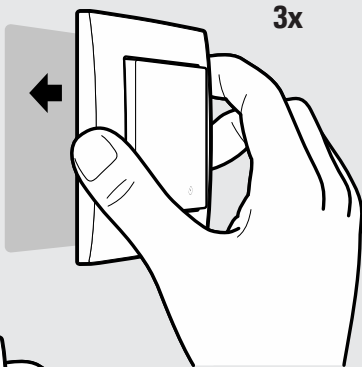

1x

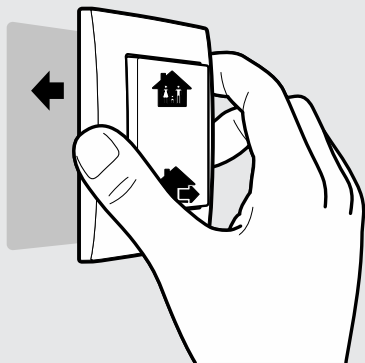

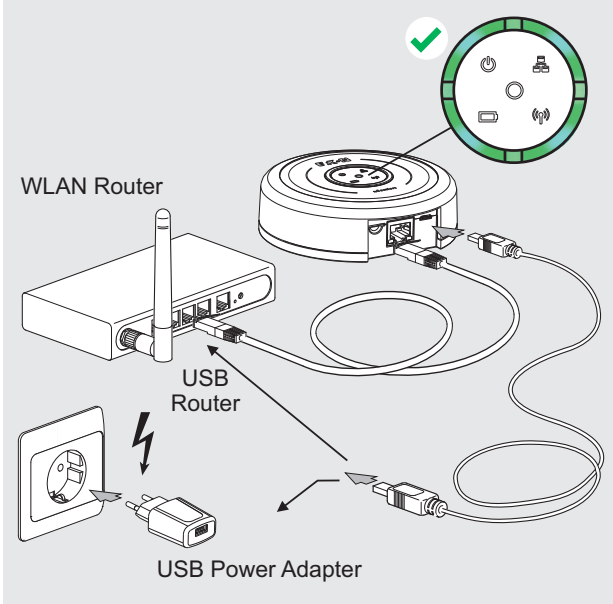
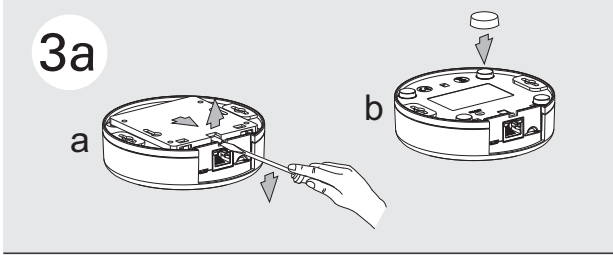
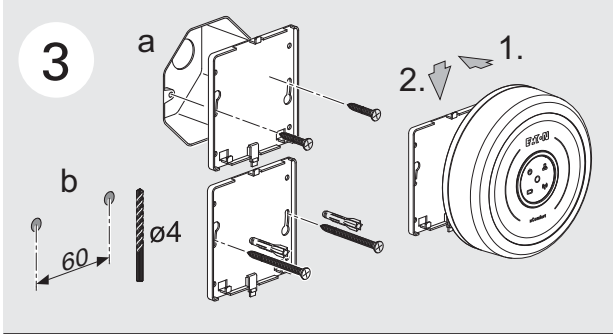
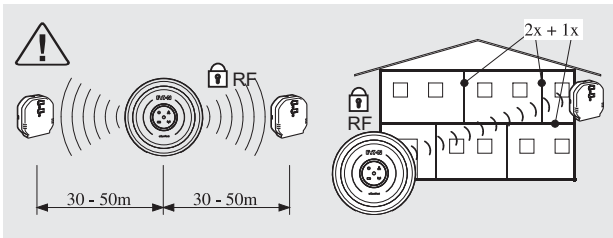

4



xComfort Bridge

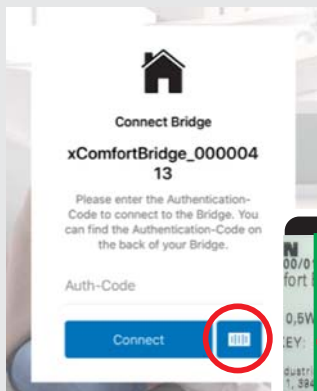
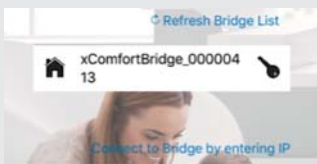

**EN Start App, select your xComfort Bridge and follow the Instructions. The Bridge must be in the same network!**

NO Start app, velg xComfort Bridge og følg videre instruksjer.  
xComfort Bridge må være i samme lokale nettverk!

NL Start de app, selecteer uw xComfort Bridge en volg de instructies op. De xComfort Bridge moet zich in hetzelfde netwerk bevinden!

DE Starten Sie die App, wählen Sie Ihre xComfort Bridge aus und folgen Sie den Anweisungen. Die Bridge muss sich im selben Netzwerk befinden!

CZ Spusťte aplikaci, vyberte svůj xComfort Bridge a postupujte podle pokynů. Bridge musí být ve stejné síti!"

5

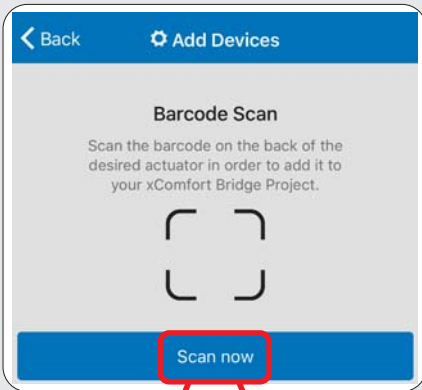
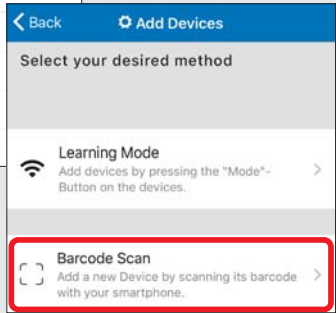
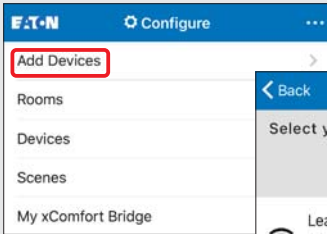

a

b

3x

3x



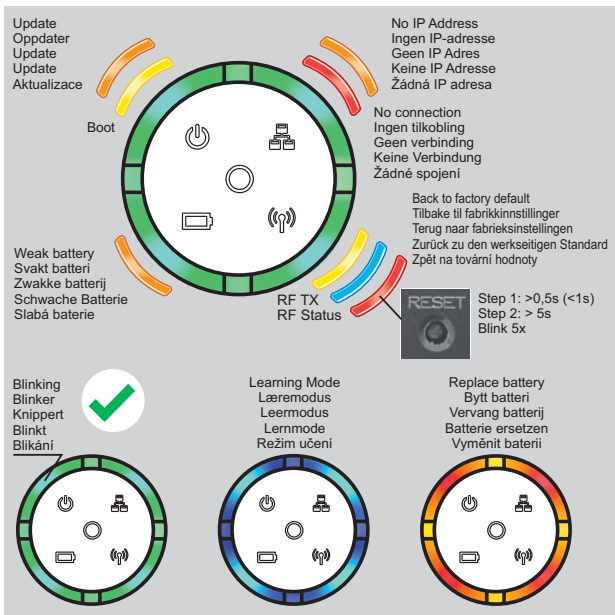

## Technical Data / Technische gegevens / Tekniske data / Technische Daten / Technická data

Power supply	230 VAC +10% -15%, 50Hz
Load	R,L,C: 0 - 100 W (0 - 100 VA); LED, ESL: 0 - 100 W (TYP)
Eaton Smart Dimming technology with overload protection	
Auto trailing / leading edge mode	6 DIM Profiles
Max RF power	25 mW (ERP)
Standby	Aktor: 210 mW (TYP) / Bridge: <0.5 W
Battery	CR2450N 3V (included)
Battery lifetime	10 years (TYP)
RF	868,3MHz (xComfort compatible)
Degree of protection	IP20
Actor	-5 to +55°C
Sensor	+5 to +45°C

