

Data Sheet | Item Number: 713-1103/032-9037

1-conductor female connector, 2-row; CAGE CLAMP®; 1.5 mm²; Pin spacing 3.5 mm; 6-pole; 100% protected against mismatching; Strain relief plate; direct marking; 1,50 mm²; black



<https://www.wago.com/713-1103/032-9037>



Color: ■ black

Similar to illustration

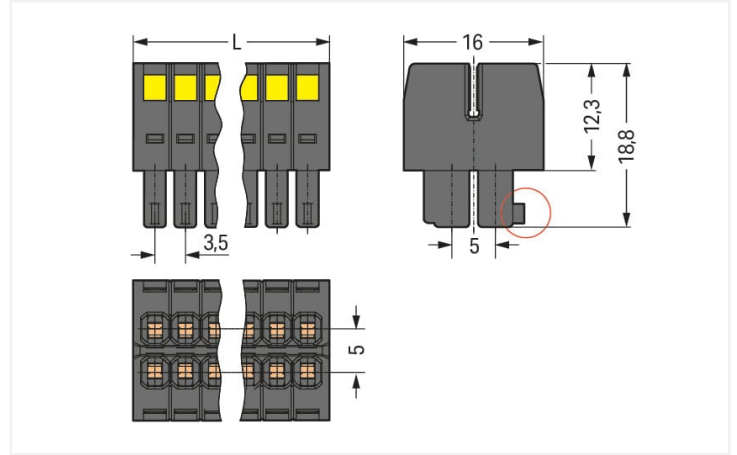

Dimensions in mm

$L = [(pole\ no./2) - 1] \times pin\ spacing + 5.2\ mm$

Coding finger (red circle)

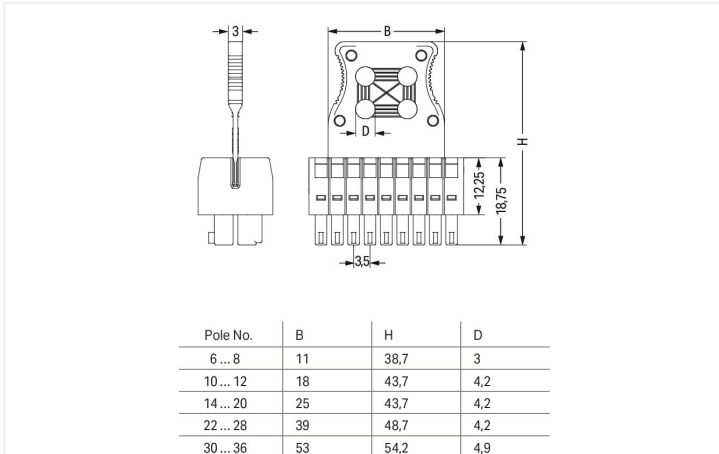

Dimensions in mm

The arrangement of the attachments for cable ties allows single conductors or multi-core cables to be secured in different ways. The width of the cable ties must correspond to the hole dimensions of the strain relief plates shown above.

Cable ties and binding tools are not offered by WAGO.

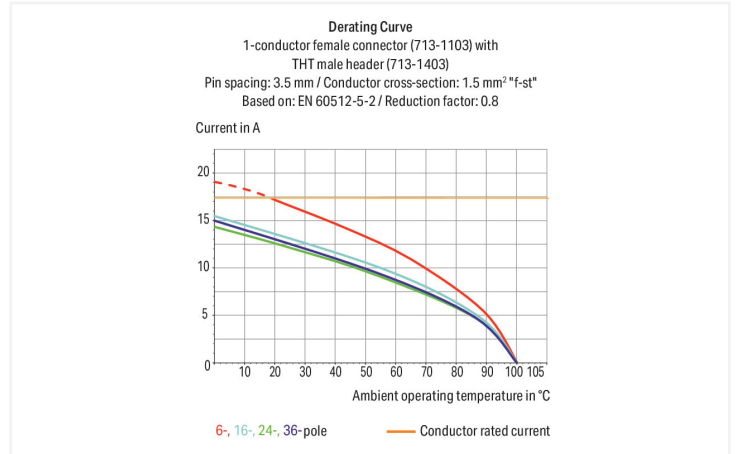

- Universal connection for all conductor types
- Unique, compact, double-row connector system for conductor cross-sections up to 1.5 mm²
- High-density, wire-to-board connections in very confined spaces
- Centered strain relief plate anchors conductors, while acting as convenient connection and disconnection handle. It also provides easy access to operating slots – even when wired.
- Coding fingers provide 100% protection against mismatching

Notes

Safety information

The MCS – MULTI CONNECTION SYSTEM includes connectors without breaking capacity in accordance with DIN EN 61984. When used as intended, these connectors must not be connected/disconnected when live or under load. When used as intended, these connectors must not be connected/disconnected when live or under load. The circuit design should ensure header pins, which can be touched, are not live when unmated.

Variants:

Other pole numbers
Gold-plated or partially gold-plated contact surfaces
Other versions (or variants) can be requested from WAGO Sales or configured at <https://configurator.wago.com/>.

Electrical data

Ratings per		IEC/EN 60664-1			Approvals per		UL 1059		
Overvoltage category		III	III	II	Use group	B	C	D	
Pollution degree		3	2	2	Rated voltage	300 V	50 V	-	
Nominal voltage		80 V	160 V	250 V	Rated current	10 A	10 A	-	
Rated surge voltage		2.5 kV	2.5 kV	2.5 kV					
Rated current		10 A	10 A	10 A					

Approvals per		CSA		
Use group		B	C	D
Rated voltage		300 V	-	-
Rated current		10 A	-	-

Connection data

Connection points	6	Connection 1			
Total number of potentials	6	Connection technology	CAGE CLAMP®		
Number of connection types	1	Actuation type	Operating tool		
Number of levels	2	Actuation direction 1	Operation perpendicular to conductor entry		
		Solid conductor	0.08 ... 1.5 mm ² / 28 ... 16 AWG		
		Fine-stranded conductor	0.08 ... 1.5 mm ² / 28 ... 16 AWG		
		Fine-stranded conductor; with insulated ferrule	0.25 ... 1 mm ²		
		Fine-stranded conductor; with uninsulated ferrule	0.25 ... 1 mm ²		
		Strip length	6 ... 7 mm / 0.24 ... 0.28 inches		
		Pole number	6		
		Conductor entry direction to mating direction	0°		

Physical data

Pin spacing	3.5 mm / 0.138 inches
Width	12 mm / 0.472 inches
Height	38.7 mm / 1.524 inches
Depth	16 mm / 0.63 inches

Mechanical data

Variable coding	Yes
Anti-rotation protection	Yes

Plug-in connection

Contact type (pluggable connector)	Female connector/socket
Connector (connection type)	for conductor
Mismating protection	Yes
Strain relief	Strain relief plate

Material data

Note (material data)	Information on material specifications can be found here
Color	black
Material group	II
Insulation material	Glass fiber-reinforced polyamide (PA66 GF)
Flammability class per UL94	V0
Clamping spring material	Chrome-nickel spring steel (CrNi)
Contact material	Copper alloy
Contact plating	Tin
Fire load	0.064 MJ
Weight	3.7 g

Environmental requirements

Limit temperature range	-60 ... +100 °C
Processing temperature	-35 ... +60 °C

Commercial data

Product Group	3 (Multi Conn. System)
eCl@ss 10.0	27-14-11-06
eCl@ss 9.0	27-14-11-06
ETIM 8.0	EC001284
ETIM 7.0	EC001284
PU (SPU)	100 pcs
Packaging type	Box
Country of origin	PL
GTIN	4050821176893
Customs tariff number	85366990990

Environmental Product Compliance

CAS-No.	131651-65-5 144317-44-2 220133-51-7 220689-12-3 25628-08-4 29420-49-3 375-73-5 503155-89-3 507453-86-3 68259-10-9
REACH Candidate List Substance	Perfluorobutane sulfonic acid (PFBS) and its salts
RoHS Compliance Status	Compliant,With Exemption
RoHS Exemption	6(c) 7(a) 7(c)-I 7(c)-II

Environmental Product Compliance

SCIP notification number (Austria)	2749dcb8-2f17-4e4c-b173-5cd064a7ed32
SCIP notification number (Belgium)	2ca12b9e-30e0-4523-b3c9-5c94004e9fa7
SCIP notification number (Bulgaria)	aa2d1117-5f8c-4493-9355-b605c594844a
SCIP notification number (Czech Republic)	8239159e-74bd-4de8-9e93-8827185db897
SCIP notification number (Denmark)	7fbe1144-3432-4321-8817-fb0d0e765a22
SCIP notification number (Finland)	5bf6cc13-3d1e-4e92-ab6d-9ed363337791
SCIP notification number (France)	b937d657-befd-4fd4-b8ac-31f37875c666
SCIP notification number (Germany)	cd7ce554-e5e3-4cc3-a80e-be2a4d077d99
SCIP notification number (Hungary)	c84dcc75-d3d0-4400-8878-7738c31855df
SCIP notification number (Italy)	9c4d96d1-986f-4d7b-bdf3-c57c21a0ab20
SCIP notification number (Netherlands)	fdad47c4-758b-4a61-8094-69ce6d248200
SCIP notification number (Poland)	db74d4c0-2bd3-4f8f-8990-da30121c63bb
SCIP notification number (Romania)	ce899056-37e1-496d-82de-0bf741198cfc
SCIP notification number (Sweden)	1d244cfa-3fba-47fa-8d2e-7f76e1b6c3ad

Approvals / Certificates

General approvals



Approval	Standard	Certificate Name
UR Underwriters Laboratories Inc.	UL 1059	E45172

Downloads

Environmental Product Compliance

Compliance Search
Environmental Product Compliance 713-1103/032-9037 

Documentation

Additional Information
Technical Section 03.04.2019 pdf 2010.85 KB 

1 Compatible Products

1.1 System counterpart

1.1.1 Male connector/plug



Item No.: 713-1423

THT male header, 2-row; 0.8 x 0.8 mm solder pin; angled; 100% protected against mismatching; Pin spacing 3.5 mm; 6-pole; black

Item No.: 713-1403

THT male header, 2-row; 0.8 x 0.8 mm solder pin; straight; 100% protected against mismatching; Pin spacing 3.5 mm; 6-pole; black

1.2 Optional Accessories

1.2.1 Ferrule

1.2.1.1 Ferrule



Item No.: 216-301

Ferrule; Sleeve for 0.25 mm² / AWG 24; insulated; electro-tin plated; yellow



Item No.: 216-321

Ferrule; Sleeve for 0.25 mm² / AWG 24; insulated; electro-tin plated; yellow



Item No.: 216-151

Ferrule; Sleeve for 0.25 mm² / AWG 24; uninsulated; electro-tin plated



Item No.: 216-131

Ferrule; Sleeve for 0.25 mm² / AWG 24; uninsulated; electro-tin plated; silver-colored



Item No.: 216-302

Ferrule; Sleeve for 0.34 mm² / 22 AWG; insulated; electro-tin plated; light turquoise



Item No.: 216-322

Ferrule; Sleeve for 0.34 mm² / 22 AWG; insulated; electro-tin plated; light turquoise



Item No.: 216-132

Ferrule; Sleeve for 0.34 mm² / AWG 24; uninsulated; electro-tin plated



Item No.: 216-152

Ferrule; Sleeve for 0.34 mm² / AWG 24; uninsulated; electro-tin plated



Item No.: 216-241

Ferrule; Sleeve for 0.5 mm² / 20 AWG; insulated; electro-tin plated; electrolytic copper; gastight crimped; acc. to DIN 46228, Part 4/09.90; white



Item No.: 216-201

Ferrule; Sleeve for 0.5 mm² / 20 AWG; insulated; electro-tin plated; white



Item No.: 216-221

Ferrule; Sleeve for 0.5 mm² / 20 AWG; insulated; electro-tin plated; white



Item No.: 216-141

Ferrule; Sleeve for 0.5 mm² / 20 AWG; insulated; electro-tin plated; electrolytic copper; gastight crimped; acc. to DIN 46228, Part 1/08.92



Item No.: 216-101

Ferrule; Sleeve for 0.5 mm² / AWG 22; uninsulated; electro-tin plated; silver-colored



Item No.: 216-121

Ferrule; Sleeve for 0.5 mm² / AWG 22; uninsulated; electro-tin plated; silver-colored



Item No.: 216-242

Ferrule; Sleeve for 0.75 mm² / 18 AWG; insulated; electro-tin plated; electrolytic copper; gastight crimped; acc. to DIN 46228, Part 4/09.90; gray



Item No.: 216-262

Ferrule; Sleeve for 0.75 mm² / 18 AWG; insulated; electro-tin plated; electrolytic copper; gastight crimped; acc. to DIN 46228, Part 4/09.90; gray



Item No.: 216-202

Ferrule; Sleeve for 0.75 mm² / 18 AWG; insulated; electro-tin plated; gray



Item No.: 216-222

Ferrule; Sleeve for 0.75 mm² / 18 AWG; insulated; electro-tin plated; gray



Item No.: 216-142

Ferrule; Sleeve for 0.75 mm² / 18 AWG; uninsulated; electro-tin plated; electrolytic copper; gastight crimped; acc. to DIN 46228, Part 1/08.92



Item No.: 216-102

Ferrule; Sleeve for 0.75 mm² / AWG 20; uninsulated; electro-tin plated; silver-colored



Item No.: 216-122

Ferrule; Sleeve for 0.75 mm² / AWG 20; uninsulated; electro-tin plated; silver-colored



Item No.: 216-243

Ferrule; Sleeve for 1 mm² / AWG 18; insulated; electro-tin plated; electrolytic copper; gastight crimped; acc. to DIN 46228, Part 4/09.90; red



Item No.: 216-263

Ferrule; Sleeve for 1 mm² / AWG 18; insulated; electro-tin plated; electrolytic copper; gastight crimped; acc. to DIN 46228, Part 4/09.90; red



Item No.: 216-203

Ferrule; Sleeve for 1 mm² / AWG 18; insulated; electro-tin plated; red



Item No.: 216-223

Ferrule; Sleeve for 1 mm² / AWG 18; insulated; electro-tin plated; red



Item No.: 216-103

Ferrule; Sleeve for 1 mm² / AWG 18; uninsulated; electro-tin plated



Item No.: 216-143

Ferrule; Sleeve for 1 mm² / AWG 18; uninsulated; electro-tin plated; electrolytic copper; gastight crimped; acc. to DIN 46228, Part 1/08.92



Item No.: 216-123

Ferrule; Sleeve for 1 mm² / AWG 18; uninsulated; electro-tin plated; silver-colored

1.2.2 Stickers with operating instructions

1.2.2.1 Stickers with operating instructions



Item No.: 210-493

Stickers for operating instructions

1.2.3 Strain relief

1.2.3.1 Strain relief plate



Item No.: 713-126

Strain relief plate; for female connectors; 11 mm wide; 1 part; Pin spacing 3.5 mm; black

1.2.4 Tool

1.2.4.1 Operating tool



Item No.: 210-719

Operating tool; Blade: 2.5 x 0.4 mm; with a partially insulated shaft



Item No.: 210-647

Operating tool; Blade: 2.5 x 0.4 mm; with a partially insulated shaft; multicoloured

Installation Notes

Conductor termination

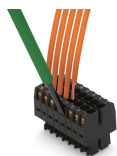

Inserting a conductor via (2.5 x 0.4) mm screwdriver.

Locking system

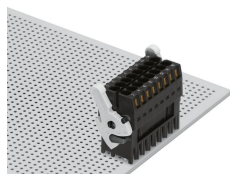

Lever as a lock – when closed, female connector is locked.

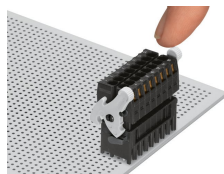

Lever as a disconnection aid – when opened, female connector is disconnected. Rotating the lever lifts the female connector out of the male header.

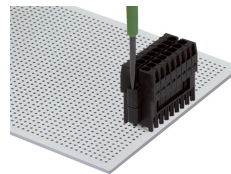

Screw interlock can only be disconnected using a tool.

Coding

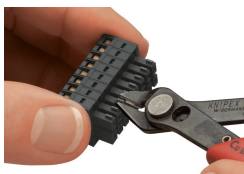

Coding a female connector by removing coding finger(s).

Strain relief

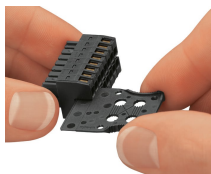

Strain relief plate for field assembly

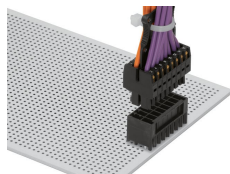

Centered strain relief plate anchors conductors for easy disconnection.