

Explosion-proof telephone

Ex ResistTel



Operating instructions



Our explosion-proof, weather-resistant telephone is a captivating product on account of its precision, convenience, long service life and reliability. It is freely programmable and the optimum choice for adverse ambient conditions. Be it seawater, high atmospheric humidity, dust or the toughest mechanical strains, the weather-resistant telephone accomplishes its aim in any conditions. The reason for this is the robust keypad made of V4A steel and an extremely solid housing made of impact-resistant and shockproof cast-moulding material. All of the components utilised are even resistant to leeches and lubricants. The 21-component V4A-steel keypad - which can be operated by a user wearing gloves - and the easily readable alphanumeric display as well as the uncomplicated menus all ensure simple operation - thus fulfilling the requirements for a leading-edge and operationally reliable means of communication. As a telephone suitable for connecting to the public telephone network and to private automatic branch exchanges, the ExResistTel always ensures reliable connections.

ExResistTel ZB is designed for telephone exchange operation and corresponds to the ExResistTel, except for keypad and display.

Table of contents

General operating instructions	4
Overview of the device	5
Display and keyboard	8
Contents after unpacking.....	9
ZB version notes	9
Explosion protection – device description	10
Explosion protection – device construction	11
Explosion protection – characteristic data	14
Explosion protection – identification.....	15
Assembly and installation	16
Connection diagram.....	17
Sling holder	18
Drilling diagram	18
Start-up.....	19
Maintenance.....	19
Handset mode.....	19
Open Listening.....	19
Hands-free talking.....	19
Working with the headset	20
Menu.....	21
Main Menu.....	22
Submenu: Telephone Book.....	23
Submenu: Change Telephone Book.....	24
Submenu: Lock / PIN.....	25
Submenu: Settings.....	26
Submenu: Languages.....	27
Default Settings.....	27
Menu overview	28
Technical data.....	29
Guidelines and regulations	32
Service	33
Maintenance and servicing.....	33
Waste disposal.....	33
Warning and safety instructions	33
CE symbol	35
EMC-Directive	35
Index of catchwords.....	36
EC Declaration of Conformity.....	37

General operating instructions

1. Both the explosion-proof ExResistTel telephone and the ZB version are designed for connection to dial ports with analogue connection points.
2. The handset is fitted with a stray-field coil for connecting hearing-aids. People who use hearing-aids which have an inductive receiver can receive the earphone signal directly.
3. The optional, external loudspeaker has three operating modes – calling/ringing, open listening and hands-free. If the external loudspeaker is switched on, the internal loudspeaker volume will be reduced.
4. The ZB version is not equipped with keypad and display, therefore not all the features are available with this version.
5. The ExResistTel has a handset module with a dry reed contact as a hook switch. In order to terminate an existing call connection, the handset must be hung up. In order to interrupt an existing call connection, it is sufficient to press the clearing key on the keypad.(see page 8)
6. Use the menu to program the appropriate settings. To access the menu, pick up the handset and press the "YES" key.
7. If you take longer than 2 minutes before you begin making a choice, the power supply of the exchange may be switched off. If that occurs, you will no longer hear a dialling tone. In that case, please replace the handset and wait 2 seconds before picking it up again.
8. When a setting is stored successfully, this is confirmed by an acknowledgement tone.
9. When you receive a call, the ExResistTel rings at the ringer-volume level selected by you and, for the duration of the calling sound, the symbols (((■))) appears on the display.
10. If you enter a PIN with the menu you can restrict or block dial functions. Forgetting the PIN is the equivalent of losing a key. If you forget the PIN, please contact our technical support.
11. You have a guarantee period of 24 months commencing from the date of purchase. If you have a problem, please contact our technical support in Germany, located in Mülheim an der Ruhr:

Telephone: 0208 8268 102 · Fax: 0208 8268377
e-mail: info@fhf.de

From outside of Germany, please prefix the country code:
Telephone: +49 208 8268 102 · Fax: +49 208 8268377

If a fault occurs which cannot be rectified by telephone, please send the whole telephone along with a copy of the sales receipt to the following address:

FHF
Support ExResistTel
Gewerbeallee 15-19
D-45478 Mülheim an der Ruhr
Germany

If, on examination of the telephone, it is discovered that a fault is not the case, you will be charged a service fee.

Overview of the device

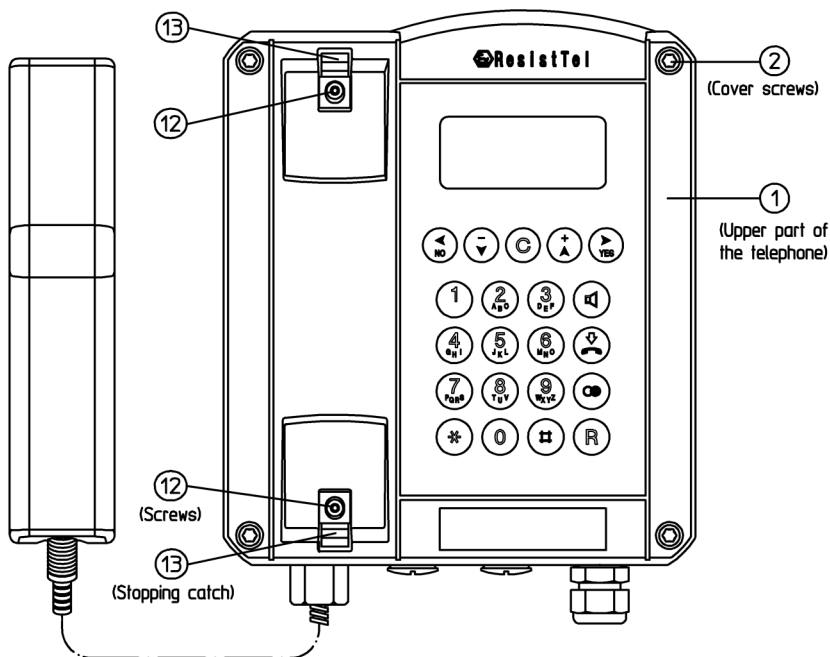

Note: In case of the ZB version, the keypad and display are replaced by a solid metal plate.

Outside view of telephone lower part

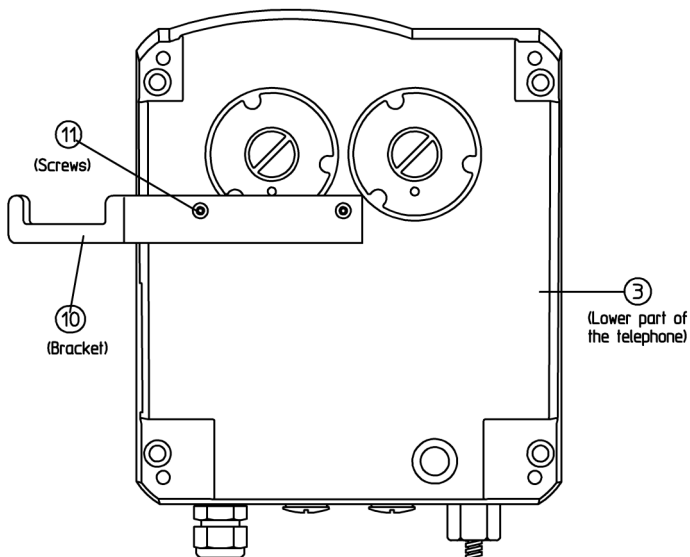

Inside view of telephone upper part

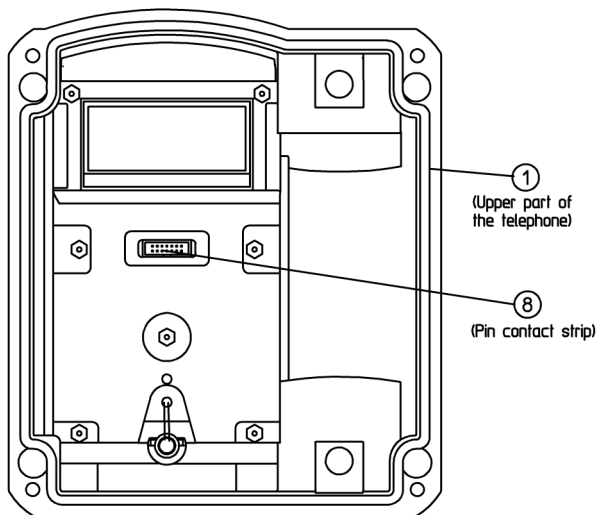

Note: The ZB version is not equipped with a pin contact strip.

Inside view of telephone lower part

Protection Class II – Components

Factory supplied with: plastic cable entry.

Note: The ZB model does not have a keypad connector or display.

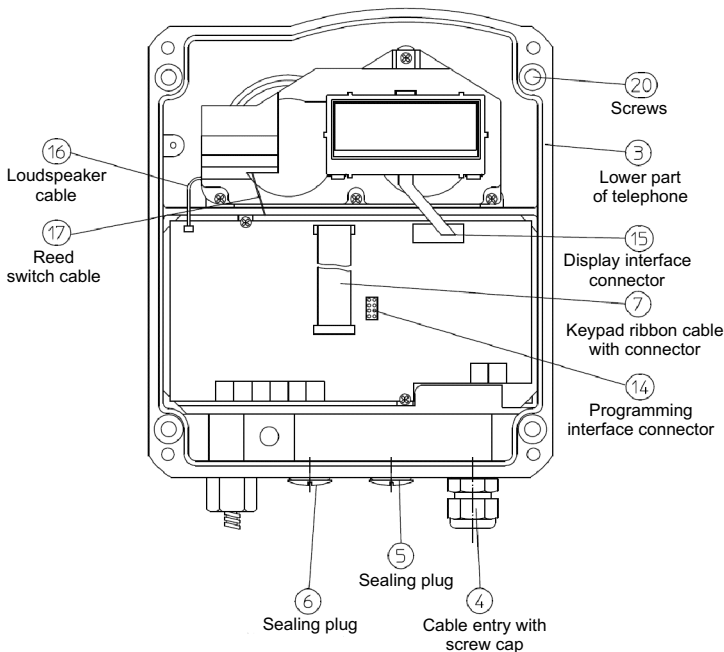

Protection Class I – Components

Factory supplied with: M20x1.5 threaded hole or a 1/2" NPT metal adapter for connecting armoured cables or conduit systems.

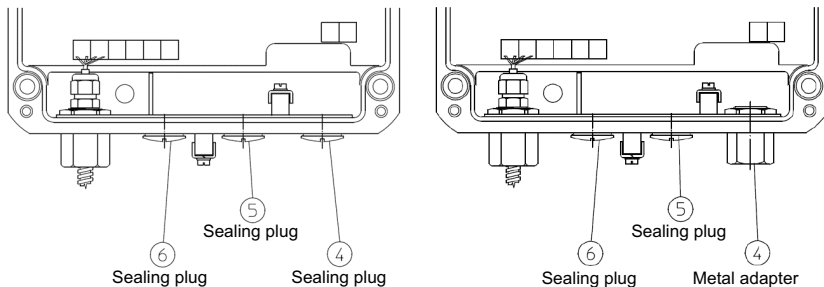

Function keys

Using these keys, you can directly change settings or make durable settings in the menu.

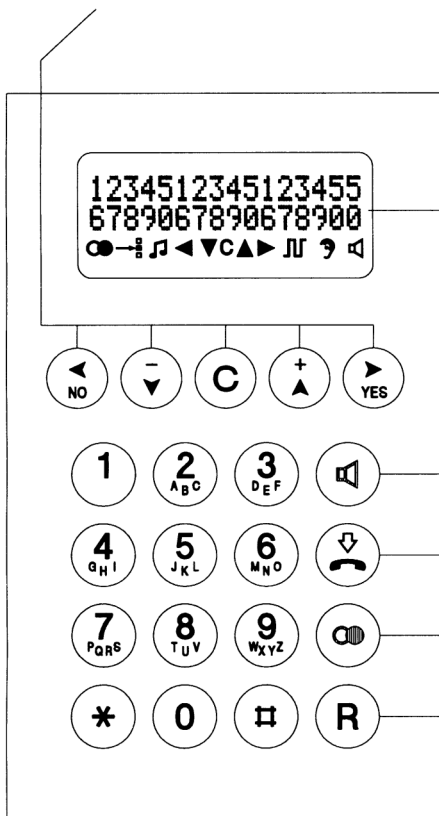

Display

The upper two lines display the call number or the menu settings. The lower line shows appropriate pictograms for the functions.

Switching key

Open listening or hands-free talking

Clearing key

Repeat dialling key

Consultation hold key

Number keys

These keys are used to enter call numbers and texts.

Contents after unpacking

The delivery includes:

- ExResistTel telephone
- Operating instructions
- 2 self-adhesive lettering plates

ZB version notes

The ExResistTel / ZB connects – depending on the features of the PABX – with the PABX while lifting the handset. The ExResistTel / ZB can be called also, because the ringing circuit is built in.

Furthermore there are interfaces for operating an optional second earpiece, an optional secondary ringer and an optional external loudspeaker.

The operating mode „external loudspeaker“ is set up by bridging the terminals 9 and 10 (HSS1, HSS2). With the ZB version this is equivalent to the open listening mode. The ringer sound is also output via the external loudspeaker.

Note:

The set up of the external loudspeaker reduces the volume of the internal ringer even if the external loudspeaker is not connected.

Thus the ZB version offers the following features:

- Establishing a connection by lifting up the receiver
- Ringing by means of integrated ringing device
- Connection of second earpiece
- Connection of secondary ringer
- Connection of external loudspeaker

Regarding the explosion protection the ExResistTel telephone and the ExResistTel telephone in ZB version are identical.

The explosion protection enables the user to make and receive calls within hazardous areas of zone 1, in presence of an explosive gas or dust atmosphere.

The ExResistTel telephone is manufactured in the following protection classes:

II 2 G Ex emb [ib] IIC T5
II 2 D Ex tD A21 IP66 T100°C
 $-25^{\circ}\text{C} \leq T_a \leq +60^{\circ}\text{C}$

II 2 G Ex emb [ib] IIC T6
II 2 D Ex tD A21 IP66 T80°C
 $-25^{\circ}\text{C} \leq T_a \leq +40^{\circ}\text{C}$

The ExResistTel telephone is designed for connection with analogue telephone networks.

The non-intrinsically safe voltage of the telephone network is connected to the terminals 13 and 14 (A, B) in increased safety. In calling/ringing mode, this voltage is switched to the terminals 15 and 16 (Bell shunt1, Bell shunt) in increased safety. The terminals 15 and 16 (Bell shunt1, Bell shunt) are intended for passive consumers, e.g. a passive external, explosion-proof secondary ringer.

Furthermore, a non-intrinsically safe voltage from the analogue telephone network is turned into:

- an intrinsically safe receiver circuit with terminals on the inside of the telephone housing, for use with the receiver, which is permanently connected to the telephone housing, and
- intrinsically safe circuits with terminals within the telephone housing for connecting an intrinsically safe headset or, optionally, an intrinsically safe second earpiece, and
- an intrinsically safe circuit with terminals within the telephone housing for the connection of an intrinsically safe loudspeaker.

The accessories headset, second earpiece, external loudspeaker and external secondary ringer are not parts of the ExResistTel telephone, but optional extras.

The unvarnished housing of the ExResistTel telephone consists of an electrostatically conductive cast-moulding equipped with a stainless steel keypad. The keypad front plate contains a display sealed by a viewing window.

The ZB version comprises no keypad and no display area, but a solid front plate.

The housing consists of a rectangular lower part, in which there has been placed a tray for mounting the electronic parts, as well as a vaulted cover with a keypad.

The cover and the lower part of the housing, divided by a surrounding seal only, are pressed together by four screws. The cover makes up both the non-intrinsically safe and the intrinsically safe electrical enclosure. The electronics circuit board is situated in the tray of the lower part of the housing, completely embedded in a protective compound.

Non-intrinsically safe terminals in increased safety:

Protruding from the compound (see connecting diagram on page 17), a 4-pole increased-safety terminal row is intended for connecting the non-intrinsically safe telephone network (A, B), terminals 13 and 14, as well for connecting an optional, external, explosion-protected secondary ringer (Bell shunt1, Bell shunt), terminals 15 and 16.

Intrinsically safe terminals:

Protruding from the compound (see connecting diagram on page 17), a 12-pole intrinsically safe terminal row is intended for connecting the receiver, which is permanently connected with the telephone housing, terminals 1 to 4, as well as the intrinsically safe accessories, terminals 5 to 12.

The terminals 7 and 8 are intended for the connection of dynamic receiver insets, like the ones used in second earpieces and headsets. This output thus can be used for connecting a second earpiece or a headset, which means that a second earpiece and a headset cannot be connected simultaneously.

Terminal	Note	Use
1	Dynamic receiver inset connection 1	Receiver inset
2	Dynamic receiver inset connection 2	
3	Electret-foil microphone connection (+)	Receiver microphone
4	Electret-foil microphone connection (-)	
5	Electret-foil microphone connection (+)	Headset Microphone, not for ZB version
6	Electret-foil microphone connection (-)	
7	Dynamic receiver inset connection 1	Headset or second earpiece
8	Dynamic receiver inset connection 2	
9	Jumper between the terminals 9 and 10 is identified by the telephone as headset connected. or – in case of the ZB version – as external loudspeaker connected.	Headset identification or –ZB version –identification of external loudspeaker
10		
11	Dynamic loudspeaker connection 1	External loudspeaker
12	Dynamic loudspeaker connection 2	

To connect accessories, you must replace the blind plugs screwed into the telephone housing by explosion-proof cable glands (M20x1.5).

Before connecting intrinsically safe accessories, and if a system certificate for the intended connection does not exist, the constructor should perform an evaluation of the intrinsic safety according to the PTB report "Zusammenschaltung nichtlinearer und linearer eigensicherer Stromkreise" (Interconnection of non-linear and linear intrinsically safe electrical circuits), PTB-ThEx-10, from November 1999 (ISBN 3-89701-440-9).

The technical data for the evaluation of the intrinsic safety can be found in the chapter "Explosion protection – characteristic data".

Further information see EN60079-14 “Electrical apparatus for explosive gas atmospheres - Part14: Electrical installations in hazardous areas” and EN50281-1-1 “Electrical apparatus for use in the presence of combustible dust”. The user shall observe the standard EN50281-1-2 (IEC61241-1-2) if the device operates in hazardous areas with combustible dust.

A metal bracket is supplied for hanging up the intrinsically safe second earpiece or headset. The metal bracket should be attached to the telephone by means of the two threaded bushes in the floor of the telephone housing. The corresponding bores in the metal bracket can be used to screw the bracket securely onto to the housing floor (see overview of the device on page 6). Thus, if the constructor wants to use the metal bracket, the first thing he has to do, is to fix it to the housing floor. Subsequently, the device may be mounted on the wall.

Intrinsically safe programming interface

An 8-pole, intrinsically safe contact strip (**14**) (see overview of the device on page 7) protrudes from the compound. This contact strip is exclusively used by the manufacturer for programming purposes. Do not switch any circuits by using the contact strip. The constructor may not perform any kind of programming.

Intrinsically safe display interface

An 8-pole, intrinsically safe contact strip with a soldered-on circuit board (**15**) (see overview of the device on page 7) protrudes from the compound. The circuit board is equipped with a zero power plug for connecting the intrinsically safe LC display film conductor. Connect the built-in display only to this interface.

Intrinsically safe strand connection to the built-in loudspeaker

An intrinsically safe 2-pole strand conductor (**16**) (see overview of the device on page) goes from the compound to the built-in loudspeaker. The strand is soldered onto the circuit board below the compound, as well as onto the loudspeaker.

Intrinsically safe strand connection to the reed switch

An intrinsically safe, 2-pole strand conductor (**17**) goes from the compound to a circuit board with a reed switch (see overview of the device on page 7). On the compound-covered circuit board the strand runs underneath the compound, and on the other circuit board it is soldered onto the reed switch.

Intrinsically safe keypad connection

An intrinsically safe, 14-pole ribbon cable with plug bush (18) comes out of the compound. Prior to screwing the device parts together, connect this plug bush with the 14-pole pin contact strip in the housing cover.

Explosion protection – characteristic data

1. Non-intrinsically safe electrical circuits

1.1 Telephone network

(Terminals A / B No.: 13 – 14)

Maximum input voltage U_m (ringing voltage) AC 90 V
Admissible frequency range 16...54 Hz

or

Maximum input voltage U_m (supply voltage) DC 66 V
Maximum rated input current 100 mA
Maximum input short circuit current I_k 35 A

(At the input of this device there is a melting fuse with a breaking capacity of 35 A)

1.2 External secondary ringer:

For connection with passive consumers only
(Terminals Bell shunt1 / Bell shunt No.: 15 –16)

Maximum ringing voltage AC 90 V
Frequency range 16...54 Hz

or

Maximum supply voltage DC 66 V

2. Intrinsically safe electrical circuits

2.1 Headphones accessory (microphone)

(Terminal pair HSM No.: 5 – 6)

Maximum	output voltage	U_o	17	V
Maximum	output current	I_o	90	mA
Maximum	output power	P_o	80	mW
Maximum	external capacitance	C_o	375	nF
Maximum	external inductivity	L_o	1	mH

2.2 Headphones accessory (receiver inset) or second earpiece

(Terminal pair HSR No.: 7 – 8)

Maximum	output voltage	U_o	17	V
Maximum	output current	I_o	110	mA
Maximum	output power	P_o	190	mW
Maximum	external capacitance	C_o	375	nF
Maximum	external inductivity	L_o	1.2	mH

2.3 Headphones accessory (identification)

(Terminal pair HSS No.: 9 – 10)

Maximum	output voltage	U_o	17	V
Maximum	output current	I_o	8	mA
Maximum	output power	P_o	33	mW
Maximum	external capacitance	C_o	375	nF
Maximum	external inductivity	L_o	100	mH

2.4 External loudspeaker

(Terminal pair SPK No.: 11 – 12)

Maximum	output voltage	U_o	6,6	V
Maximum	output current	I_o	250	mA
Maximum	output power	P_o	370	mW
Maximum	external capacitance	C_o	22	μ F
Maximum	external inductivity	L_o	0.3	mH

2.5 All intrinsically safe output electrical circuits have a linear output characteristic curve.

3. Ambient temperature range

-25°C < T_a < 60°C for temperature class T5

-25°C < T_a < 40°C for temperature class T6

Explosion protection – identification

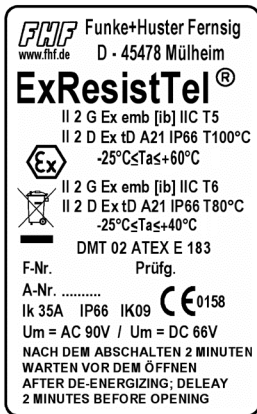

Insulation class I

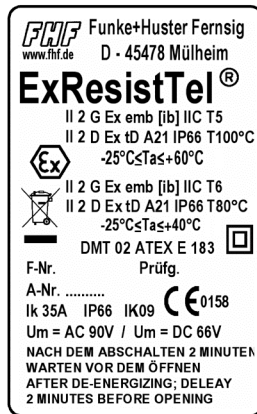

Insulation class II

Figure Type Plates

Telephone / Telephone ZB, Type ExResistTel

The device must be installed on a plane surface only, in vertical operating position. Loosen the cover screws (2) (see overview of the device on page 5 to 7). and detach the upper part of the telephone (1). If the optional accessory headset or a second earpiece is being employed, attach the bracket (10) using two screws (11) to the rear panel of the lower part of the telephone. (With the accessories named before, the bracket and screws are in the scope of delivery. With all accessories a cable gland is delivered.) Put four screws, having a head diameter of 10 to 13 mm into the holes (20) and attach the lower part of the telephone (3) to the wall or to a holder.

Installation differs depending on the type of telephone model. On the telephone with factory equipped plastic cable entry, the telephone network cable should be passed through the cable entry (4) and connected to terminals 13 and 14 (A, B) in accordance with the connection diagram. Only use cables with a sheath diameter of 5 to 9 mm because otherwise the IP66 enclosure protection rating may be compromised.

On the telephone with the M20x1.5 threaded opening or the 1/2" NPT threaded opening, the customer is responsible for mounting a cable entry. Follow the manufacturer's instructions supplied with the cable entry assembly. Only cable entries with EU type approval for IP66 enclosure protection rating and $-25^{\circ}\text{C} \leq T_a \leq 60^{\circ}\text{C}$ should be used and they should provide a good seal and fit tightly to the cable. On this model (Protection Class I), make sure the PE (protective earth) wiring is connected properly. Corresponding connection points are provided and marked inside and outside of the housing. The telephone network cable must be connected to terminals 13 and 14 (A, B) as shown on the connection diagram. If a torque of more than 20 Nm is used to tighten down the sealing rings of the cable entry, then the side of the cable entry assembly nearest the housing should be secured against rotating.

Connecting a second ringer (bell-shunt) (optional accessory)

Remove the sealing plug (5) and tighten the M20x1.5 cable gland cap. Insert the wire of the second ringer and place it on the terminals in accordance with the connection diagram. Only utilise wires which have a sheath diameter of 5 to 9 mm because otherwise the IP66 housing protection standard is not guaranteed.

Connecting an external loudspeaker (optional accessory)

Remove the sealing plug (6) and tighten the M20x1.5 cable gland cap. Insert the wire of the loudspeaker and place it on the terminals 11 and 12 (SPK+, SPK-) in accordance with the connection diagram. Only utilise wires which have a sheath diameter of 5 to 9 mm because otherwise the IP66 housing protection standard is not guaranteed.

Connecting a headset (optional accessory)

Remove the sealing plug (6) and tighten the M20x1.5 cable gland cap. Guide the specially-manufactured wire with the headset socket (included in the delivery of the headset) through the cable screw cap and place it on the terminals 5 through 10 (HSM+, HSM-, HSR+, HSR-, HSS1, HSS2) in accordance with the connection diagram. Only the wire included in the delivery for the headset should be used because otherwise the IP66 housing protection standard is not guaranteed.

Connecting a second earpiece (optional accessory)

Remove the sealing plug (6) and tighten the M20x1.5 cable gland cap. Insert the wire of the second earpiece and place it on the terminals 7 and 8 (HSR+, HSR-) in accordance with the connection diagram.

Prior to assembly, check cover seal for tightness.

Using the plug connector (7), plug the ribbon cable onto the pin contact strip (8) in the upper part of the housing.

Attach the upper part of the telephone and fasten it to the lower part of the telephone with the four cover screws (2).

Upon disassembly of optional accessories, suited blind plugs must be used to close the resulting openings.

Connection diagram

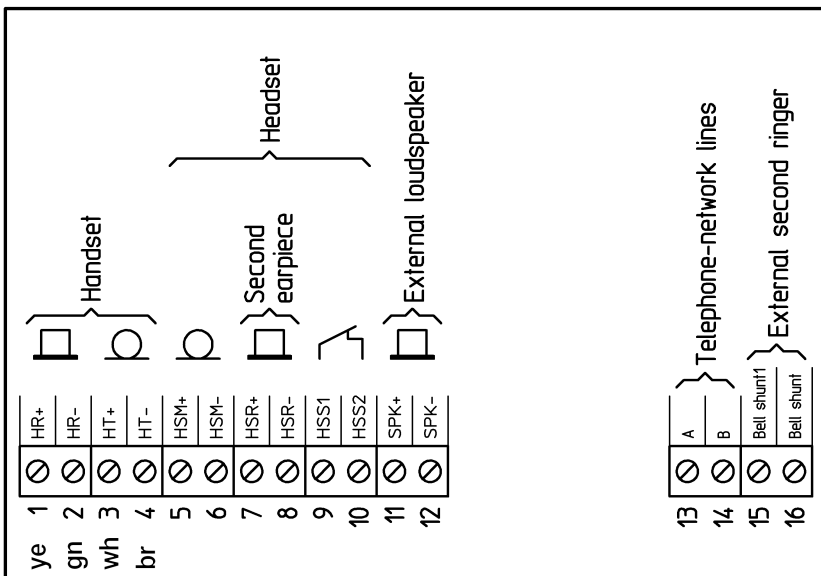

Sling holder

The holding strength for the handset is continuously adjustable. Loosen the screws (12) and move the stopping catches (13). Pushing the stopping catches together increases the holding strength whereas pulling them apart reduces it. Tighten the screws again.

Drilling diagram

For making a drilling template please use the following dimensions (in mm).

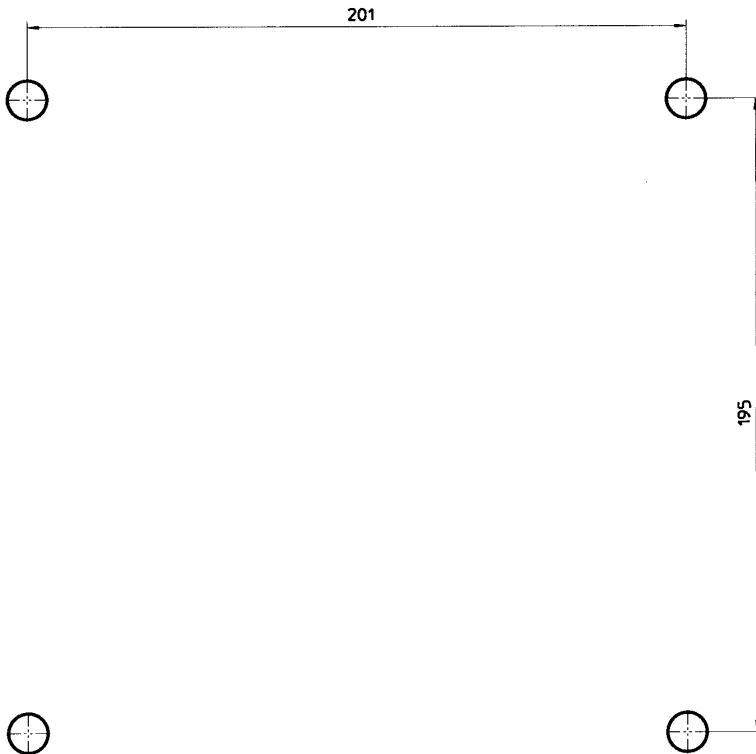

The diameter of the drilled hole is dependent on the screw employed (screw diameter max. 8 mm) and the type of supporting base material (steel, wood, concrete, plasterboard etc.) and must be chosen accordingly.





Start-up

The ExResistTel telephone is ready for operation as soon as it has been connected to the telephone network.





Maintenance

The ExResistTel telephone contains no parts that have to be maintained.





Handset mode (except ZB version)

When you pick up the handset, you are in handset mode. Using the keys  and , you can adjust the handset volume for talking. If you wish to durably change the handset volume, use the menu "Settings / Handset volume". Using the key  you can switch into open listening mode. If you keep the key  depressed and replace the handset, you switch to hands-free talking mode.

Open Listening mode (except ZB version)

Using the keys  and , you can adjust the loudspeaker volume for talking. If you wish to change the loudspeaker volume durably, use the menu "Settings / Loudspeaker". The handset volume cannot be changed in open listening mode. Using the key , you can switch to handset mode. If you keep the key  depressed and replace the handset, you switch to hands-free-talking mode.

Hands-free mode (except ZB version)



If you switch on the ExResistTel using the key  you are in hands-free-talking mode. Using the keys  and  you can adjust the loudspeaker volume for talking. If you wish to durably change the loudspeaker volume, use the menu "Settings / Loudspeaker". You end the call using the key . If you pick up the handset, you switch to handset mode.

Working with the headset (except ZB version)

If the headset has been connected correctly, it takes the place of hands-free talking. For this reason, hands-free talking with the headset is not possible. If you switch on the ResistTel with the key , you are operating in headset mode. If you lift the handset while in headset mode, the handset assumes a higher priority. That means that it is possible to speak and listen using the handset but, in this mode, it is only possible to listen with the headset.

Comparison of the operating states without and with connected headset:

Operation without the headset	Operation with the headset
<u>Handset mode</u>	<u>Handset mode with the headset</u> <ul style="list-style-type: none">- Handset can speak and listen- Headset can only listen- Loudspeaker is off
<u>Open Listening mode</u>	<u>Open Listening with the headset</u> <ul style="list-style-type: none">- Handset can speak and listen- Headset can only listen- Loudspeaker is on
<u>Hands-free mode</u>	<u>Headset mode</u> <ul style="list-style-type: none">- Handset is replaced- Headset can speak and listen- Loudspeaker is off

Using the keys  and  you can adjust the headset volume for talking. If you wish to durably change the headset volume, use the menu "Settings / Headset Volume". You end the call using the key .

Menu (except ZB version)

Starting the menu

Press the key .

You are now situated in the main menu.

The top line of the display indicates the menu in which you are located.

The lower line indicates which menu item is selected.

Selecting menu items

Press the key  or .

The upper line of the display remains unchanged. In the lower line, the menu items available for selection change with each key-press.

Activating a menu item



Press the key .

The menu item which was indicated in the lower line is now located in the upper line. In the lower line, you see the additional options available.



Exiting the menu

Press the key .

With each key-press, you jump to the previous menu. When you arrive back in the main menu, you exit it with the next key-press .



With the aid of the key  or , you can make selections under the following items:

- Telephone Book For selecting a telephone number from the telephone book memory.
- Change Phonebook For creating new telephone book entries
For modifying existing telephone book entries
For deleting existing telephone book entries
- Lock / PIN For changing to the submenu Direct call
For setting the complete lock
To permit selections from the telephone book only
For disabling or enabling the main menu items "Settings", "Languages" and "Change Phonebook"
For changing the PIN
- Settings For adjusting the ringer volume and changing the melody
Adjust the loudspeaker volume
Adjust the handset volume
Adjust the headset volume
Adjust the LCD contrast
Set the dialling method
Set the flash time
Set the exchange number and pause
Restoring to the default dettings
Switch on/off an external loudspeaker
Welcome text
- Languages For selecting the menu language German
For selecting the menu language English
For selecting the menu language Spanish
For selecting the menu language French
For selecting the menu language Italian

When you select an item, you can activate it with the key . You can exit the menu with the key .



Submenu – Telephone Book (except ZB version)

You have the option of dialling up to 50 telephone numbers from the telephone book. To store and/or change numbers, see the menu item "Change telephone book".

You can select from the telephone book entries using the key  or .

Examples:



- FIRE BRIGADE dials the telephone number shown on the display
999
- SECURITY dials the telephone number shown on the display
110
- FHF MUELHEIM dials the telephone number shown on the display
020882680
- CANTEEN dials the telephone number shown on the display
123
- etc. dials the telephone number shown on the display

When you have selected a telephone number to call, you can dial it by pressing the key . You can exit the menu using the key .



Submenu – Change Telephone Book (except ZB version)

You can store up to 50 telephone numbers and their associated names. Enter the numbers and names in their order of importance because they later appear on the display in the order in which they were entered (e.g. fire brigade before canteen).

Caution: The menu item "Default Settings" deletes all telephone book entries.

With the aid of the key  or , you can make selections under the following items:

- New Entry To make a new entry
- Change Entry To change an entry
- Delete Entry To delete an entry
- Delete All To delete the entire telephone book

When you have selected an item, you can activate it by pressing the key . You can exit the menu using the key .

Submenu – Lock / PIN (except ZB version)

When you call up the menu "Lock / PIN", you are prompted to enter the PIN. The PIN consists of 4 digits. In the state when delivered, the PIN is "0 0 0 0".

If you change the PIN, don't forget the new PIN. Forgetting the PIN is the equivalent of losing a key. If you forget the PIN, please contact our technical support.

Technical support in Germany, located in Mülheim an der Ruhr:

Telephone 0208 8268 102



Fax 0208 8268 377

e-mail info@fhf.de



From outside of Germany, please prefix the country code:

Telephone +49 208 8268 102

Fax +49 208 8268 377

When you have entered the PIN, you can make selections under the following items with the aid of the key  or  :

- Direct Call To switch on the direct call
To enter the direct call number
- Total Lock Locks the telephone preventing all outgoing calls
Caution: It is also not possible to dial emergency telephone numbers
- Directory Only Only permits outgoing calls to numbers contained in telephone book
- Settings For disabling or enabling the main menu items "Settings", "Languages" and "Change Phonebook"
- Change PIN To change the PIN



When you have selected an item, you can activate it by pressing the key . You can exit the menu using the key .

Note:

When the settings are disabled the main menu items "Settings", "Languages" and "Change Phonebook" are only accessible after entering the PIN.

The menu item "Default Settings" resets all settings except, however, the PIN you may have changed and the language.

Submenu – Settings (except ZB version)

With the aid of the key  or , you can make selections under the following items:

- Ringer
 - For setting the ringer volume
 - For setting the ringer melody
- Speaker Volume
 - For setting the loudspeaker volume
- Handset Volume
 - For setting the handset volume
- Headset Volume
 - For setting the headset volume
- LCD Contrast
 - For setting the display contrast
- Dialling
 - Dialling method DTMF/ duration 90 ms
 - Dialling method Pulse Dial 2:1
 - Dialling method Pulse Dial 1.5:1
 - Dialling method DTMF / duration 70 ms
 - Dialling method DTMF / duration = keypress
- Flash time
 - Set the flash time, 40 ms to 399 ms
- PABX Settings
 - Entry of the exchange number
 - Deletion of the exchange number
 - Setting the dialling pause after the exchange number
- Defaults
 - Reset to the state when delivered
- External Speaker
 - Switch on/off an external loudspeaker

Note:

The optional, external loudspeaker has three operating modes ringing, open listening and hands-free. If it is switched on, the internal loudspeaker volume will be reduced.

- Welcome text
 - input of an individual text, which is indicated in the display after taking off the handset.

For example:

BRANCH 170
EXTERNAL DEPOT



When you have selected an item, you can activate it by pressing the key





. You can exit the menu using the key



Submenu - Languages (except ZB version)

You can make selections under the following items with the aid of the key  or  :

- German For setting the menu language to German
- English For setting the menu language to English
- Spanish For setting the menu language to Spanish
- French For setting the menu language to French
- Italian For setting the menu language to Italian

When you have selected an item, you can activate it by pressing the key . You can exit the menu using the key .

Default Settings

To enable you to use the telephone immediately after connecting it, we have made default settings for general utilisation purposes. Using the menu, you can alter these default values in accordance with your own personal necessities and connection requirements.

Upon delivery of the telephone, the following default values are set:

- Telephone book: deleted
- Repeat dialling: deleted
- Direct call number: deleted
- Exchange number: deleted
- Ringer melody: 0
- Ringer volume: 6 (maximum value)
- Handset volume: 0 (normal value)
- Headset volume: 2
- Loudspeaker volume: 4
- Welcome text FHF
- External loudspeaker: switched off
- Dialling method: DTMF, signal duration 90 ms
- Flash time: 80 ms
- LCD contrast: 5 (normal value)
- Pause length after exchange number: 3 seconds
- PIN: 0000

Caution!

Resetting to the default settings via the menu restores these default values with the exception of the PIN and the language:

- The PIN is not changed.
- The language is not changed.

Menu overview (except ZB version)

Main Menu

Telephone Book		
Name #1	To	Telephone book entry #1 is dialled
Name #50	To	Telephone book entry #50 is dialled

Change Telephone Book

New Entry	Add a new entry to the telephone book
Change Entry	A telephone book entry is changed
Delete Entry	A telephone book entry is deleted
Delete All	The entire telephone book is deleted

Lock / PIN

Direct Call		
Activate		The direct call is switched on
Change Number		Change or enter the direct call number
Total Lock		The telephone is locked completely
Directory Only		Telephone is locked except for numbers in the telephone book
Settings		The main menu items "Settings", "Languages" and "Change Phonebook" are disabled or enabled.
Change PIN		The PIN is changed (default 0000)

Settings

Ringer		
Volume		The ringer volume is set
Melody		The ringer melody is set
Speaker Volume		The loudspeaker volume is set durably
Handset Volume		The handset volume is set durably
Headset Volume		The headset volume is set durably
LCD Contrast		The LCD contrast is set
Dialling		
DTMF 90ms		Sets the dialling method to DTMF 90 ms
Pulse Dial 2.0 : 1		Sets the dialling method to PDM 2: 1
Pulse Dial 1.5 : 1		Sets the dialling method to PDM 1.5: 1
DTMF 70ms		Sets the dialling method to DTMF 70 ms
DTMF		Sets the dialling method to DTMF unlimited
Flash Time		Set the flash time to between 40 and 399 ms
PABX Settings		
Enter Exchange Code		Entry of an exchange number
Clear Exchange Code		The exchange number is deleted
Pause Exchange Code		Set dialling pause to between 1 and 6 s
Defaults		Resets to the state when delivered and the telephone book is deleted
Ext. Speaker		Switch on/off external loudspeaker
Welcome text		change

Languages

German	Menu language German is activated
English	Menu language English is activated
Spanish	Menu language Spanish is activated
French	Menu language French is activated
Italian	Menu language Italian is activated

Technical data

Warning!

In order to maintain the explosion protection it is of paramount importance to observe the information given in the chapter “Explosion protection – characteristic data” on pages 14 and 15.

Note:

Except for ZB version for items marked with an asterisk *).

Connection data	
Supply voltage	24 V _{DC} to 66 V _{DC}
Supply current	15 mA _{DC} to 100 mA _{DC}
Ringer voltage	24 V _{AC} to 90 V _{AC} (calling frequency 21...54 Hz) 30 V _{AC} to 90 V _{AC} (calling frequency 16.6...54 Hz)
Ringer impedance	Greater than 6.0 kΩ at 25 Hz and 24...90 V _{AC} . Greater than 4.0 kΩ at 50 Hz and 24...90 V _{AC} .
Consultation hold key *)	Flash function adjustable from 40 ms to 399 ms via the menu.
Dialling method *)	PD or DTMF mode can be set via the menu. DTMF mode in accordance with ITU-T recommendation Q.23. Pulse Dial mode with pulse pause ratio 1.5:1 or 2:1 (adjustable via the menu).
Exchange number*)	An exchange number and dialling pause are programmable to between 1 s and 6 s via the menu.
Bell-Shunt	Possibility for connecting a second external ringer.
External speaker	Terminals for the connection of an external speaker (optional accessory).
Headset *)	Terminals for the connection of a headset (optional accessory). Note: A headset or a second earpiece can be connected, but not both simultaneously !
Second earpiece	Terminals for the connection of a second earpiece (optional accessory). Note: A headset or a second earpiece can be connected, but not both simultaneously !
Connection terminals	Up to 4 mm ² inflexible. Up to 2.5 mm ² flexible.

Housing	
Material	Glass-fibre-reinforced polyester
Height x width x depth	approx. 260 mm x 228 mm x 135 mm
Weight	approx. 5.5 kg
Display *)	2-line alphanumeric display with pictograms. Field of view approx. 78 mm x 26 mm.
Keyboard *)	- Metal keyboard with protection against ice. - 21 keys with ABC inscription for name entries.
Position of operation	Mounted upright on the wall. The device must be mounted on a plane surface only.
Protection Class I	M20 x 1.5 threaded hole or threaded 1/2" NPT adapter for cable entry assembly.
Protection Class II	Plastic cable entry for cable diameters: Ø 6 to 13 mm
Handset	
Sling protection	Integrated, adjustable sling protection.
Handset cord	Steel-reinforced steel-clad cord made of V4A.
Earphone	Dynamic capsule with stray-field coil for the inductive connection of hearing-aids.
Microphone capsule	Electret microphone
Noise suppression	Greater than 3 dB by integrated speak-in horn.
Ambient conditions	
Protection type:	IP 66 as per EN60529
Protection against external mechanical impacts	IK 09 as per EN50102
Operating temperature:	-25°C to +60°C (display does not operate below -20°C)
Storage temperature:	-25°C to +70°C as per IEC60721
Additional features	
Clearing key *)	Separate key
Hook switch	Dry reed contact without a mechanical cradle
Power supply	- from the analogue telephone network. - no additional mains supply required.
Meter-pulse lock	- Electrical attenuation for 12 kHz and 16 kHz on the earphone greater than 30 dB with respect to 1 kHz.

	<p>- Impedance (telephone connections A, B):</p> <p>approx. 13 kΩ (1 V_{eff} ; 12 kHz ; idle state)</p> <p>approx. 4 kΩ (10 V_{eff} ; 12 kHz ; idle state)</p> <p>approx. 2.5 kΩ (1 V_{eff} ; 12 kHz ; during a call)</p> <p>approx. 2.3 kΩ (10 V_{eff} ; 12 kHz ; during a call)</p> <p>approx. 11 kΩ (1 V_{eff} ; 16 kHz ; idle state)</p> <p>approx. 4 kΩ (10 V_{eff} ; 16 kHz ; idle state)</p> <p>approx. 2.5 kΩ (1 V_{eff} ; 16 kHz ; during a call)</p> <p>approx. 2.3 kΩ (10 V_{eff} ; 16 kHz ; during a call)</p>
Optical call *) signalling	Display indicates ((()))
Ringer volume	<p>- Approx. 90dB(A) at a distance of 1 m at 50 V_{AC} / 50 Hz (In the default settings. The maximum volume is also dependent on the selected melody and on the power-supply conditions).</p> <p>- 6-step volume and mute mode can be set via the menu. (The ringer volume is reduced by approx. 12 dB(A) if the optional external loudspeaker is switched on in the menu).</p>
Ringer melodies *)	10 melodies can be selected via the menu.
Open Listening	<p>- Maximum volume approx. 68 dB(A) at a distance of 1 m</p> <p>- 7-step volume can be set via the menu. *)</p> <p>- Durable setting via the menu *) (The internal loudspeaker volume is reduced if the optional external loudspeaker is switched on in the menu).</p>
Hands-free *)	<p>- Function possible where ambient noise do not exceed 68 dB(A). (at greater noise levels, it is not possible to understand the telephone conversation in hands-free mode).</p> <p>- Maximum loudspeaker volume approx. 68 dB(A) at a distance of 1 m</p> <p>- 7-step volume can be set via the menu.</p> <p>- Durable setting via the menu (The open listening volume is reduced if the optional external loudspeaker is switched on in the menu).</p>
Handset loud function *)	<p>- Handset volume from 0 dB to +12 dB.</p> <p>- 7-step volume can be set via the menu.</p> <p>- Durable setting via the menu.</p>
Menus *)	- In German, English, Spanish, French and Italian.

	- An audible signal is given if programming was successful.
Telephone book *)	- A maximum of 50 entries with name and telephone number.

Guidelines and regulations	
Conformity to the following guidelines and regulations:	<ul style="list-style-type: none"> - ATEX Directive 94/9/EC - R&TTE directive 1999/5 EC - Low Voltage Directive 73/23/EC - EMC Directive RL89/336/EC for the domestic / residential and industrial areas - ETSI TBR 38: May 1998 (acoustics) - ETSI TBR 21: January 1998 (telephone-network access) but without device-internal DC limitation to 60 mA (see TBR21 item 4.7.1 DC characteristics) <p>Advisory notes ETSI EG201121V1.1.2 (1998-07):</p> <ul style="list-style-type: none"> - ATAAB AN 003, 004, 013 relevant to all countries - ATAAB AN 005, 006, 007, 009, 010 and DE 03, 04,05, 08, 09, 12, 14, 17 for Germany - FTZ 121TR8: May 1994 Part 2.1 and 2.2 for the performance feature open listening - FTZ 121TR8: May 1994 Part 2.1, 2.2 and 3 for the performance feature hands-free talking - Pulse dialling method in accordance with BAPT 223 ZV5 version 07.96 (where dialling method PDM 1.5:1 is set) - Pulse dialling method in accordance with BS6305:1982 with change AMD 4558:1984 (where dialling method PDM 2:1 is set) - Meter-pulse lock for 12 kHz BAKOM 337/2.2: 12/1997 - Meter-pulse lock for 16 kHz in the general meaning of BAKOM 337/2.2: 12/1997 - FTZ 121TR8: November 1993 Part 3.1 for the magnetic field generator in the handset

Service

You have purchased a state-of-the-art product manufactured by **FHF** and subject to stringent quality controls. If you have questions regarding the telephone or if a malfunction has occurred – even after the guarantee period – please contact **FHF** (see page 4). Please have the type and article number ready (these numbers can be found on the type plate) when you contact us.

Maintenance and servicing

The telephone is maintenance-free. Nevertheless, if the telephone is deployed in areas with significant impurities due to dust, grease, oil etc., then it should be cleaned from time to time. The handset and the telephone should be wiped with a damp cleaning cloth. **Caution!** Never use sharp objects for cleaning.

Waste disposal

The device may be completely recycled as electronic waste. Upon disassembling the device, the plastic, metal and electronic components must be disposed of separately.

In every single case the national requirements and regulations for waste disposal must be observed.

The waste-disposal requirements of your country must be observed.

Warning and safety instructions

This equipment is an explosion-proof and weather-resistant telephone specifically designed for operation in a harsh industrial environment. The following warning and safety instructions must be heeded:

1. Do not connect or operate the telephone with voltages other than the voltages specified. Make sure the PE wiring is connected properly on the Protection Class I model. All cabling should be routed such that it does not present a tripping hazard.
2. The telephone must only be operated under the specified ambient conditions (see section "Technical data"). Adverse ambient conditions, such as e.g. ambient temperatures which are too high or too low, are not permissible because this promotes the failure of electronic components.
3. It must be ensured that the telephone, the connection wire etc. are not damaged. It is not permissible to operate the telephone in a damaged state.
4. When operating the telephone, please heed the legal and commercial / industrial regulations, accident-prevention regulations and electrical regulations / provisions.
5. Repairs are only permissible with original spare parts which must be replaced by a specialist. Other replacement parts can cause damage and render the guarantee invalid.

6. The stipulated position of utilisation must be adhered to. The telephone must be installed on a plane surface only, in vertical operating position.
7. Magnetic fields with energy technical frequencies can cause a slight impairment of the listening quality. If this is the case, please ensure that the telephone is installed at a suitable location.
8. The type of protection of the telephone is:
 - II 2 G Ex emb [ib] IIC T5
 - II 2 D Ex tD A21 IP66 T100°C
 - 25°C ≤ T_a ≤ +60°C

 - II 2 G Ex emb [ib] IIC T6
 - II 2 D Ex tD A21 IP66 T80°C
 - 25°C ≤ T_a ≤ +40°C
9. The telephone must be switched off before opening. Wait at least 2 minutes after switching off power before opening the telephone!
10. In the open state of the telephone no dust may ingress the device.
11. Upon mounting or demounting the device, do not damage the cover seal, which keeps the cover tight, or the collar on the lower part of the housing.
12. Upon repairing the apparatus for use in dust, the repaired parts should once again be subjected to a routine test.
13. The mouthpiece horn of the receiver consists of a non-conductive plastic material. It may become dangerously charged at high air speeds. Consequently, cleaning the mouthpiece horn with pressurized air is prohibited.
14. If there is a high concentration of sulphurous gases in the environment, the lettering of the keys can fade and a rust film can arise.
15. Changes to the product which are in the interests of technical progress are possible even without prior notice.

CE symbol

The ExResistTel fulfils the requirements of the R&TTE directive – 1999/5 EC (Radio equipment and telecommunications terminal equipment and the mutual recognition of their conformity).

In detail the ExResistTel complies with the Low Voltage Directive 73/23/EWG and the EMC Directive RL89/336/EG for the domestic / residential and industrial areas.

The ExResistTel complies with the ATEX -Directive 94/9/EC

The conformity of the ExResistTel with the above-mentioned directives is confirmed by the CE symbol.

EMC-Directive

The device complies with the requirements of the new EMC-directive 2004/108/EC, the low voltage directive 2006/95/EC and the R&TTE directive 1999/5/EC.

The conformity with the above directives is confirmed by the CE sign.

Index of catchwords

Assembly.....	16	Languages	27
CE symbol.....	35	Lock / PIN	25
Change telephone book	24	Loudspeaker volume	19
Complete lock	25	Maintenance and servicing	33
Connection diagram.....	17	Main menu	22
Default settings	27	Menus	21
Direct call.....	25	Menu overview.....	28
Display and keyboard	8	Open Listening	11
Display contrast	26	Overview of device	5
Drilling diagram	18	Packing contents	9
DTMF	26	Pause after exchange number	26
EC Declaration of conformity... 37		Pulse Dialling	26
EMC-Directive	35	Ringer melody	26
Exchange number.....	22	Ringer volume	26
Explosion protection – characteristic data.....	14	Second earpiece	17
device construction	11	Secondary ringer (Bell-shunt)	16
device description	10	Service	33
identification	15	Settings	26
External loudspeaker	16	Sling holder	18
External Ringer (Bell-shunt)	16	Technical data	29
Flash	26	Telephone book	23
Foreword	2	Warning and safety instructions	33
General operating instructions	4	Welcome text	20
Hands-free talking	19	ZB version notes.....	9
Handset mode	19		
Handset volume	19		
Headset	20		
Installation	16		

EG-KONFORMITÄTSERKLÄRUNG EC DECLARATION OF CONFORMITY DECLARATION CE DE CONFORMITE DECLARACIÓN DE CONFORMIDAD CE

Bezeichnung des Erzeugnisses: / Designation of Product:
Désignation du produit: / Designation del producto:

- **Robustes ExII-Telefon**
- **Ruggedized ExII-telephone**
- **ExII-téléphone robuste antidéflagrant**
- **Robusto teléfono para ExII**

Gerätetyp oder Typenbezeichnung der Einzelkomponenten:
Equipment Type or Type Designation of Individual Component:
Modèle d'appareil ou désignation de modèle des composants:
Tipo de aparato o designación del tipo de los componentes individuales:

■ **ExResistTel**

Einschlägige EG-Richtlinie(n): / Relevant EC Directive(s):
Directive(s) CE en vigueur: / Directiva(s) CE pertinente(s):

**94/9/EG: Geräte und Schutzsysteme zur bestimmungsgemäßen
Verwendung in explosionsgefährdeten Bereichen**
**94/9/EC: Equipment and protective systems intended for use in
potentially explosive atmospheres**
**94/9/CE: Appareils et systèmes de protection destinés à être utilisés
en atmosphères explosibles**
**94/9/CE: Aparatos y sistemas de protección para uso en atmósferas
potencialmente explosivas**

Angewandte harmonisierte Normen, insbesondere:
The following harmonised standards have been applied:
Normes harmonisées appliquées, notamment:
Normas armonizadas aplicadas, especialmente:

EN 60079-0 :2004
EN 60079-7 :2003
EN 60079-11 :2007
EN 60079-18 :2004
IEC 61241-0 :2004
EN 61241-1 :2004

EG-Baumusterprüfbescheinigung: / EC-Type Examination Certificate:
Attestation d'examen CE de type: / Certificado de examen CE:

DMT 02 ATEX E 183

Benannte Stelle für die Überwachung:
Notified body of inspection:
Organisme notifié de contrôle:
Organismo encargado del examen:

Kennnummer:
Inspection number: /
Numéro d'identification: /
Número de examen:

0158

■ Hiermit erklären wir, dass das nachfolgend bezeichnete Erzeugnis aufgrund seiner Konzipierung und Bauart sowie in der von uns in Verkehr gebrachten Ausführung den einschlägigen grundlegenden Sicherheits- und Gesundheitsanforderungen der(n) genannten EG-Richtlinie(n) entspricht.
Bei einer nicht mit uns abgestimmten Änderung des Erzeugnisses verliert diese Erklärung ihre Gültigkeit.

■ We herewith declare that the product identified below, based on its development and type as well as on the specific design we have brought into circulation, conforms to the relevant basic safety and health requirements of the EC Directive(s) cited below.
This declaration shall become invalid if any modification we have not authorised is made to the product.

■ Nous attestons, par le présent document, que le produit désigné ci-après a été conçu et fabriqué, quant au modèle mis en circulation par nos services, conformément aux exigences fondamentales de sécurité et de santé en vigueur de la ou des directives CE citées.
En cas de modification du produit non convenue avec nos services, la présente déclaration perd sa validité.

■ Por la presente declaramos que el siguiente producto satisface por su diseño y tipo constructivo así como en la versión comercializada por nosotros los requisitos de seguridad y salud fundamentales y pertinentes de la(s) directiva(s) CE indicada(s).
En caso de una modificación del producto no acordada con nosotros, la presente declaración pierde su validez.

■ Nous attestons, par le présent document, que le produit désigné ci-après a été conçu et fabriqué, quant au modèle mis en circulation par nos services, conformément aux exigences fondamentales de sécurité et de santé en vigueur de la ou des directives CE citées.
En cas de modification du produit non convenue avec nos services, la présente déclaration perd sa validité.

■ Por la presente declaramos que el siguiente producto satisface por su diseño y tipo constructivo así como en la versión comercializada por nosotros los requisitos de seguridad y salud fundamentales y pertinentes de la(s) directiva(s) CE indicada(s).
En caso de una modificación del producto no acordada con nosotros, la presente declaración pierde su validez.

■ Por la presente declaramos que el siguiente producto satisface por su diseño y tipo constructivo así como en la versión comercializada por nosotros los requisitos de seguridad y salud fundamentales y pertinentes de la(s) directiva(s) CE indicada(s).
En caso de una modificación del producto no acordada con nosotros, la presente declaración pierde su validez.

Diese Erklärung wird verantwortlich für den Hersteller / Importeur - This declaration is made on behalf of the manufacturer / importer - La présente déclaration, dont le fabricant / importateur ci-après assume la responsabilité - Esta declaración es formulada en forma responsable para el fabricante / importador

FHF Funke + Huster Fernsig GmbH
Gewerbeallee 15-19
45478 Mülheim an der Ruhr
Deutschland · Germany · Allemagne · Alemania

abgegeben durch: / by the authorised signatory: / est déposé par: / por

Dr. Optiz, Hans-Peter

Name, Vorname / Surname, forename / nom, prénom / apellido y nombre

Geschäftsführung / Managing Director / Direction / Gerencia

Stellung im Betrieb des Herstellers / Position in manufacturer's company / fonction dans l'entreprise du fabricant / puesto en la empresa del fabricante

Mülheim an der Ruhr

Ort / Place / ville / Lugar

Datum / Date / date / Fecha

Rechtsgültige Unterschrift / Legally binding signature / signature légitime / Firma válida

Subject to alterations
or errors



FHF Funke + Huster Fernsig GmbH

Gewerbeallee 15-19 · D-45478 Mülheim an der Ruhr
Phone +49/208/82 68-0 · Fax +49/208/82 68-286
<http://www.fhf.de> · e-mail: info@fhf.de