

Productinformatieblad

Specificaties



10"W touch panel display, 2Ethernet, USB host&device, 24VDC

HMISTW6500

EAN Code: 3606489918095

Prijs: 832,25 EUR

Hoofd

range of product	Harmony ST6
product or component type	Aanraakscherm paneel
software toewijzing	Webinterface voor operator
naam processor	ARM Cortex-A8
frequentie processor	800 MHz
geheugenbeschrijving	512 MB apparaatgeheugen 512 MB backupgeheugen 128 kB geheugen gebruikersgegevens

Complementair

afmeting display	10 inch
type display	Kleur TFT Icd
kleur display	16 miljoen kleuren
resolutie display	1024 x 600 pixels WSVGA
aanraakpaneel	Single-touch analogo resistief
levensduur achtergrondverlichting	50.000 uren met wit
helderheid	16 niveaus
tekenfont	ASCII ASCII (Europese tekens) Katakana
Us nominale voedingsspanning	24 V DC (+/- 20 %)
stroomverbruik in W	12,6 W
inschakelstroom	30 A
lokale signalering	Status LED groen, Vast voor offline Status LED groen, Vast voor in werking Status LED groen, Flitsend voor in werking Status LED groen, faded voor stand-by Status LED oranje, Flitsend voor startproces software bezig Status LED rood, Vast voor voeding (AAN) Status LED rood, Flitsend voor in werking Status LED rood, uit voor voeding (OFF)
Ethernet-poort	10/100BASE
geïntegreerd aansluitingstype	1 USB 2.0 type Aachterkant 1 Ethernet - vrouwelijke RJ45onderzijde
voeding	Externe voeding
real time klok	Ingebouwd 0...50 °C Ingebouwd 10...90% RH

De weergegeven prijs is de adviesprijs in euro excl. BTW. Deze kan onderhevig zijn aan korting. Neem contact op met uw lokale distributeur of detailhandel voor de daadwerkelijke prijs

bevestigingsmethode	Met 4 schroeven, bevestigd op 1,6...5 mm dik paneel conform aan UL 61010-2-201 Met 4 schroeven conform aan IEC 61131-2 Met 4 schroeven conform aan IEC 61000-6-2
kast materiaal	PC
materiaal frontplaat	Aluminium
markering	CE
afmetingen van boorgaten	255x185 mm afmeting paneelsnede
height	203 mm
width	273 mm
depth	47 mm
net weight	1,3 kg

Omgeving

immuuniteit voor micro-onderbrekingen	10 ms
standards	IEC 61000-6-4 IEC 61000-6-2 IEC 61131-2 UL 61010-2-201 CSA C22.2 No 61010-2-201
product certifications	CSA CE UKCA
richtlijnen	2014/35/EU - laagspanningsrichtlijn 2014/30/EU - elektromagnetische compatibiliteit
ambient air temperature for operation	0...50 °C
ambient air temperature for storage	-20...60 °C
relatieve vochtigheid	10...90 % niet-condenserend
operating altitude	2000 m
IP beschermingsgraad	IP20 conform aan IEC 61131-2 (achterpaneel) IP65 conform aan IEC 61131-2 (voorpaneel)
NEMA beschermingsgraad	NEMA 4 voorpaneel (binnentoepassing) NEMA 13 frontpaneel (in kast)
schokbestendigheid	147 m/s ² voor 11 ms (X, Y, Z richtingen voor 3 keer) conform aan IEC 61131-2
trillingsweerstand	+/-3,5 mm (f = 5...9 Hz) X, Y, Z richtingen voor 10 cycli (ongeveer 100 min) conform aan IEC 61131-2 9,8 m/s ² (f = 9...150 Hz)
elektromagnetische compatibiliteit	Elektrische snelle transiënte/burst immuuniteitstest - test level: 2 kV (stroompoorten) conforming to IEC 61000-4-4 Elektrische snelle transiënte/burst immuuniteitstest - test level: 1 kV (signaalpoorten) Elektrostatische ontlading immuuniteitstest - test level: 6 kV (contactontlading) conforming to IEC 61000-4-2 level 3 Elektrostatische ontlading immuuniteitstest - test level: 8 kV (luchtontlading)

Verpakkingseenheid

Unit Type of Package 1	PCE
Number of Units in Package 1	1
Package 1 Height	13,000 cm
Package 1 Width	28,000 cm
Package 1 Length	34,500 cm
Package 1 Weight	1,803 kg

Unit Type of Package 2	S04
Number of Units in Package 2	4
Package 2 Height	30,000 cm
Package 2 Width	40,000 cm
Package 2 Length	60,000 cm
Package 2 Weight	7,991 kg

Environmental Data

Schneider Electric wil tegen 2050 de Net Zero-status hebben bereikt via partnerschappen in de toeleveringsketen, materialen met een lagere impact en circulariteit via onze doorlopende campagne "Use Better, Use Longer, Use Again" om de levensduur van producten en de recycleerbaarheid te verlengen.

[Uitleg van Environmental Data >](#)

[Hoe evalueren we de duurzaamheid van producten? >](#)

Milieuoetafdruk

Totale levenscyclus ecologische voetafdruk 977

Milieuprofiel van product (PEP) [Milieuprofiel van het product](#)

Use Better

Materialen en verpakking

F-gasvrij Only air and vacuum used for insulation / breaking, no F-gas including SF6

Pakket met gerecycleerd karton Ja

Verpakkingen zonder kunststof Ja

EU-richtlijn RoHS Voldoet niet

SCIP-nummer 20694bec-44d9-42c3-8fdd-3861ce15e3ab

REACH-regelgeving [REACH-verklaring](#)

Use Again

Herverpakken en herfabriceren

Circulair Profiel [Informatie over einde levensduur](#)

Verwijderbare batterij Door gebruiker te vervangen

Terugname No

WEEE Label  Het product moet op markten van de Europese Unie worden afgevoerd volgens specifieke afvalinzamelingsregels en mag nooit in een gewone vuilnisbak terechtkomen.

Dimensions Drawings

Dimensions

External Dimensions

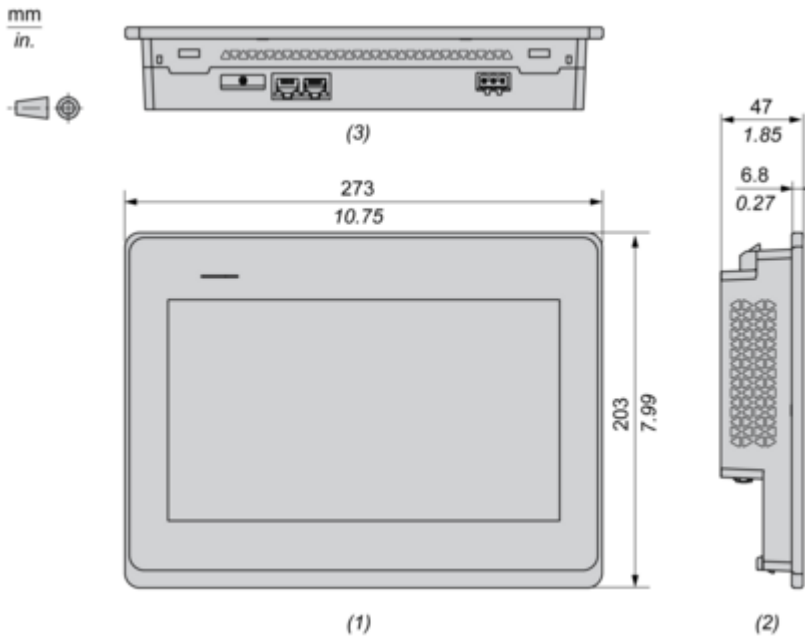

- (1) : Front
- (2) : Left
- (3) : Bottom

Dimensions with Installation Fasteners

mm
in.

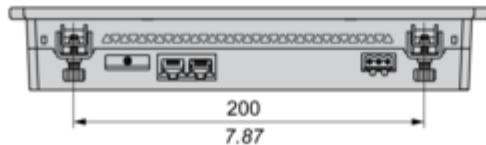

(3)

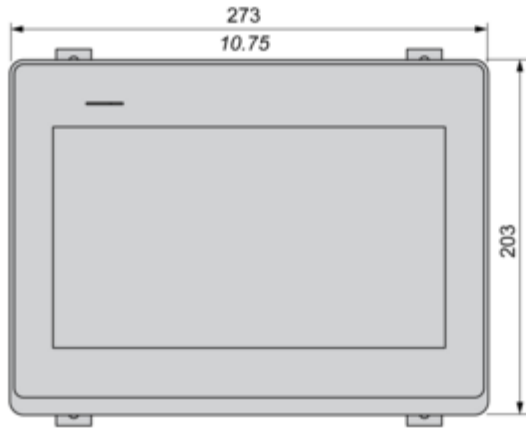

(1)

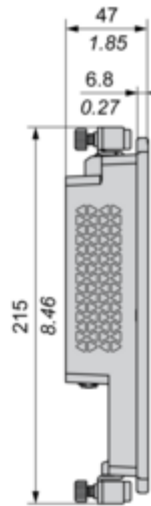

(2)

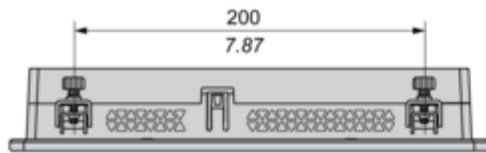

(4)

- (1) : Front
- (2) : Left
- (3) : Bottom
- (4) : Top

Dimensions with Cables

mm
in.

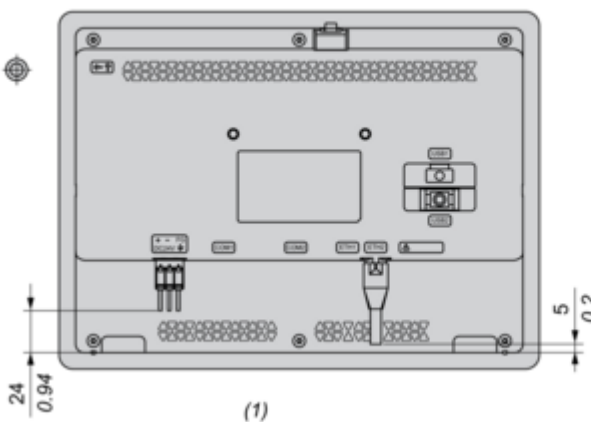

(1)

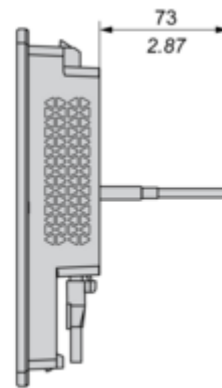

(2)

- (1) : Rear
- (2) : Right

Mounting and Clearance

Mounting

Panel Cut Dimensions

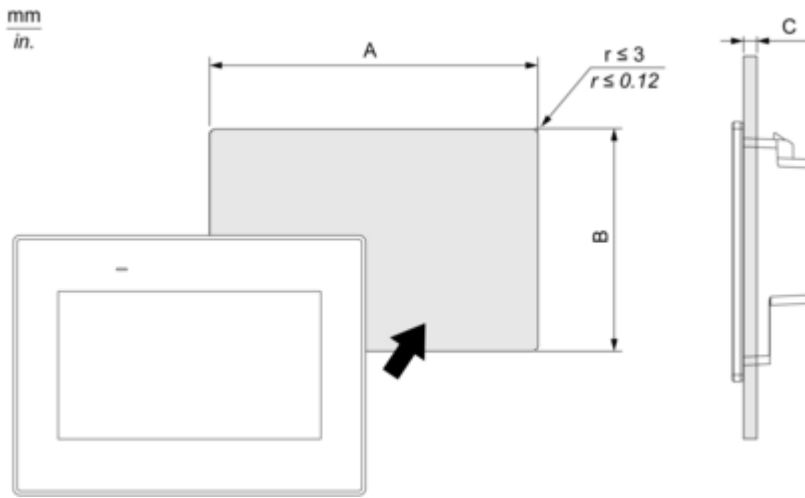

A		B		C	
mm	in.	mm	in.	mm	in.
255 (+1, -0)	10.04 (+0.04, -0)	185 (+1, -0)	7.28 (+0.04, -0)	1.6...5	0.06...0.2

Installation Requirements

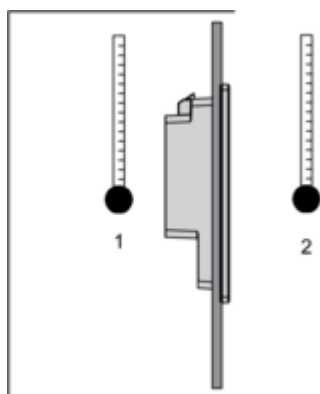

- 1 : Internal temperature
- 2 : External temperature

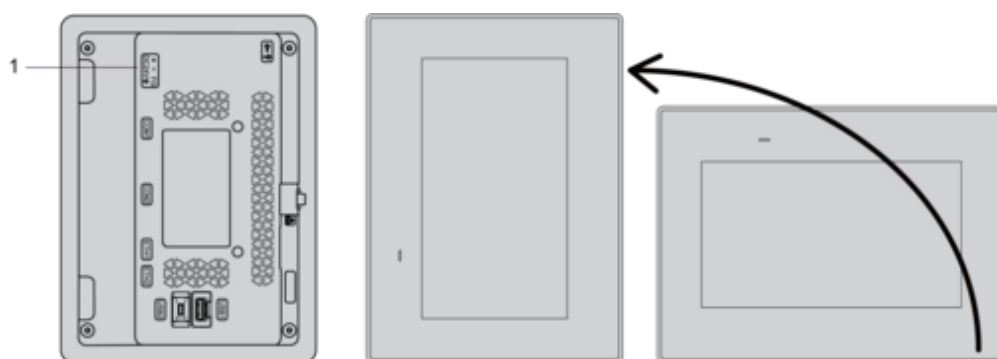

- 1 : Power connector

Mounting Angle

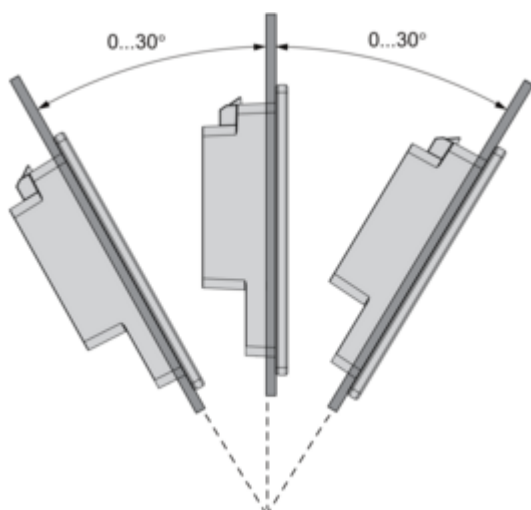

Clearance

mm
in.

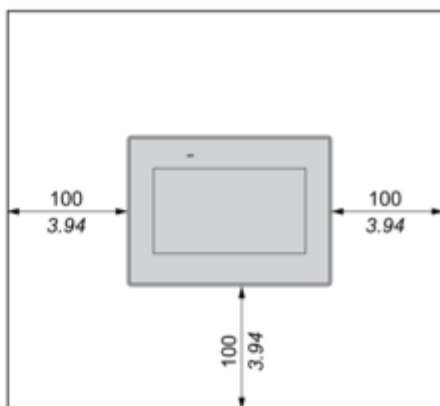
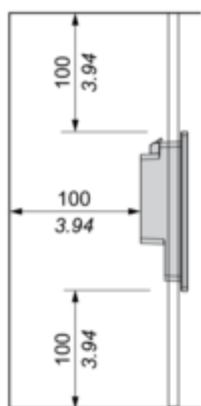

Offer Marketing Illustration

Product benefits / Features

The infographic features a central stack of four industrial HMI screens displaying various data visualizations. Surrounding this central image are six circular icons, each paired with a text description of a feature. The background is a solid light blue color.

Features

Harmony ST6 Web HMI

- Web HMI with pre-installed HTML5 browser**: Represented by a circular icon containing a browser address bar with 'www'.
- Visualize all web content of any HTTP server in industrial devices**: Represented by a circular icon containing a browser address bar with 'www'.
- Better visualization**: Represented by a circular icon containing a computer monitor displaying a bar chart.
- Cybersecurity enhancement with secure boot**: Represented by a circular icon containing a padlock.
- Simple and stylish design**: Represented by a circular icon containing three stars.
- Easy installation with tool-free fastener**: Represented by a circular icon containing two hands shaking.

Offer Marketing Illustration

Product benefits / Features

Technical Benefits

Harmony ST6 Web HMI

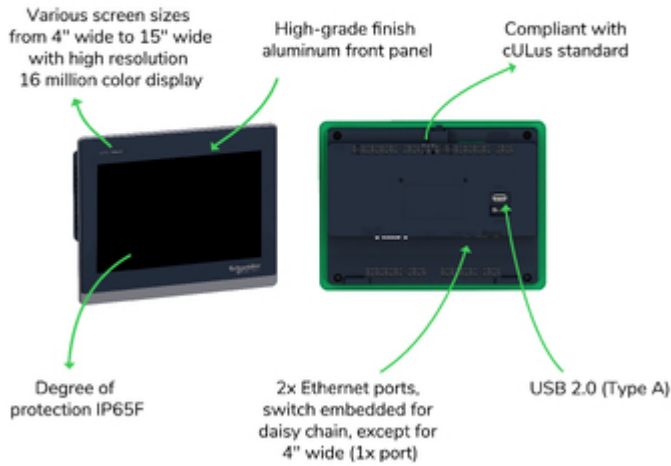

Image of product / Alternate images

Alternative



