

Data Sheet | Item Number: 232-236/005-000

Female connector for rail-mount terminal blocks; 0.6 x 1 mm pins; angled; Pin spacing 5 mm; 6-pole; gray

<https://www.wago.com/232-236/005-000>

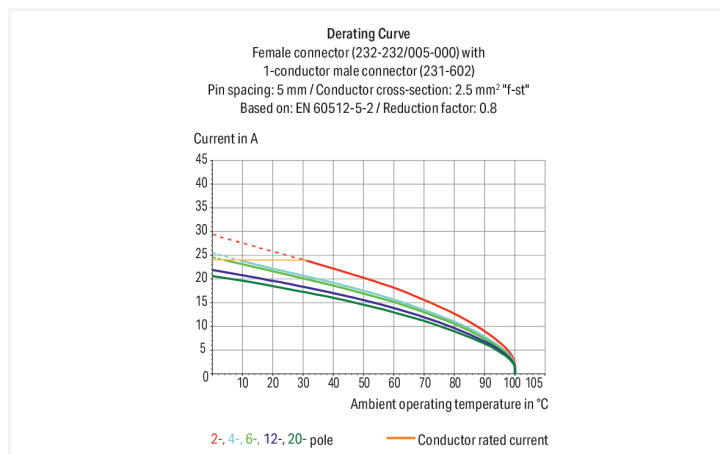

Color: ■ gray

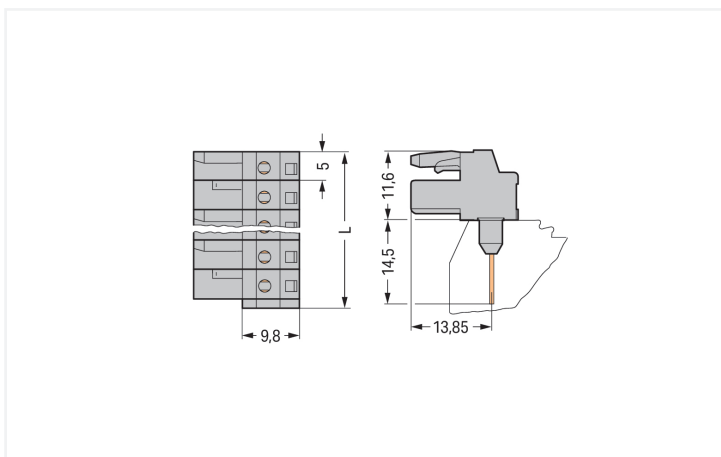

Dimensions in mm

L = (pole no. x pin spacing) + 1.5 mm 2- to 3-pole female connectors – one latch only

Female connector, 232 Series, with 5 mm pin spacing

This female connector (item number 232-236/005-000) simplifies electrical installations. The item's dimensions are (31.5 x 26.1 x 11.6) mm (width x height x depth).

Tin is used for coating the contact surfaces.

Notes

Safety Information

The MCS – MULTI CONNECTION SYSTEM includes connectors without breaking capacity in accordance with DIN EN 61984. When used as intended, these connectors must not be connected/disconnected when live or under load. When used as intended, these connectors must not be connected/disconnected when live or under load. The circuit design should ensure header pins, which can be touched, are not live when unmated.

Variants:

Other pole numbers

Other versions (or variants) can be requested from WAGO Sales or configured at <https://configurator.wago.com/>.

Electrical data

Ratings per	IEC/EN 60664-1		
Overvoltage category	III	III	II
Pollution degree	3	2	2
Nominal voltage	320 V	320 V	630 V
Rated impulse withstand voltage	4 kV	4 kV	4 kV
Rated current	12 A	12 A	12 A

Approvals per	UL 1059		
Use group	B	C	D
Rated voltage	300 V	-	300 V
Rated current	15 A	-	10 A

Approvals per	UL 1977
Rated voltage	600 V
Rated current	15 A

Approvals per	CSA		
Use group	B	C	D
Rated voltage	300 V	-	300 V
Rated current	15 A	-	10 A

Connection Data

Clamping units	6
Total number of potentials	6
Number of connection types	1
Number of levels	1

Connection 1

Pole number	6
-------------	---

Physical data

Pin spacing	5 mm / 0.197 inches
Width	31.5 mm / 1.24 inches
Height	26.1 mm / 1.028 inches
Height from the surface	11.6 mm / 0.457 inches
Depth	11.6 mm / 0.719 inches

Mechanical data

Variable coding	Yes
Anti-rotation protection	Yes

Plug-in connection

Contact type (pluggable connector)	Female connector/socket
Connector (connection type)	for front-entry rail-mount terminal block
Mismating protection	No
Mating direction to the rail-mount terminal block	0°

Material data

Note (material data)	Information on material specifications can be found here
Color	gray
Material group	I
Insulation material (main housing)	Polyamide (PA66)
Flammability class per UL94	V0
Contact material	Copper alloy
Contact Plating	Tin
Fire load	0.108 MJ
Weight	6.3 g

Environmental requirements

Limit temperature range	-60 ... +85 °C
Processing temperature	-35 ... +60 °C

Commercial data

Product Group	3 (Multi Conn. System)
PU (SPU)	50 pcs
Packaging type	Box
Country of origin	DE
GTIN	4044918569989
Customs tariff number	85366990990

Product Classification

UNSPSC	39121409
eCl@ss 10.0	27-14-11-06
eCl@ss 9.0	27-14-11-06
ETIM 9.0	EC001284
ETIM 10.0	EC001284
ECCN	NO US CLASSIFICATION

Environmental Product Compliance

RoHS Compliance Status	Compliant, No Exemption
------------------------	-------------------------

Approvals / Certificates

General approvals



Approval	Standard	Certificate Name
CB DEKRA Certification B.V.	IEC 61984	NL-113351
CSA DEKRA Certification B.V.	C22.2	1466354
KEMA/KEUR DEKRA Certification B.V.	EN 61984	71-130478 REV.1
UL Underwriters Laboratories Inc.	UL 1059	E45172

Approvals for marine applications



Approval	Standard	Certificate Name
BV Bureau Veritas S.A.	IEC 60998	11915/E0 BV

Downloads

Environmental Product Compliance

Compliance Search

Environmental Product
Compliance
232-236/005-000



Documentation

Additional Information

Technical Section

03.04.2019

pdf

2027.26 KB



CAD/CAE-Data

CAE data

EPLAN Data Portal
232-236/005-000



1 Compatible Products

1.1 System counterpart

1.1.1 Male connector/plug



Item No.: 231-606

1-conductor male connector; CAGE
CLAMP®; 2.5 mm²; Pin spacing 5 mm; 6-
pole; gray

1.2 Optional Accessories

1.2.1 Test and measurement

1.2.1.1 Testing accessories



Item No.: 231-661

Test plugs for female connectors; for 5
mm and 5.08 mm pin spacing; 2,50 mm²;
light gray