

**fischer** 

**FAZ II Plus.**  
The power  
anchor for highest  
demands.



# FAZ II Plus.

## Powerful & flexible.

The distinctive edge holds the expansion clip in position even with reinforcement hits, thus ensuring **safe installation**.

Quick and easier assembly **without the need for drill hole cleaning (M8-M24)**.

With a choice of pre-assembled **normal washer or large washer GS** and with washer **HBS** in compliance with wood construction standard DIN 1052 (not pre-assembled).

With the new assessment (ETA), the tensile strengths increase decisively. As a result, **fewer fixing points and anchors are required**.

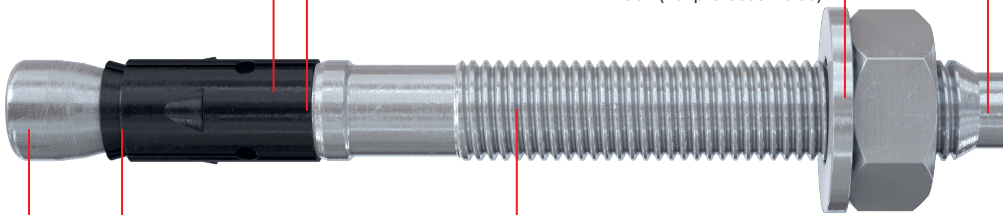

The interaction of cone and expansion clip significantly increases load-bearing capacity and makes **minimum edge distance and axial spacing possible**.

Numerous approval certificates for different substrate materials (concrete C12/15-C80/90, steel fiber concrete, solid sand-lime brick) **increase the number of applications and fields of use**.

The sizes of the special cap nut version (M10 and M12) can be used for the **application on sophisticated design**. They are also implemented in the ETA assessment.

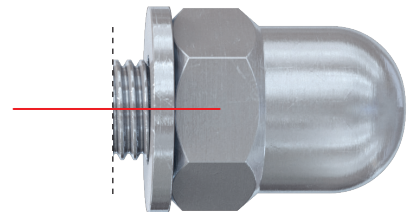

### Building materials

Suitable for building materials, such as

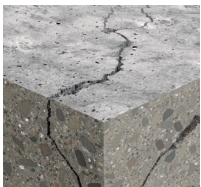

Cracked concrete

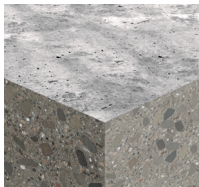

Uncracked concrete



Steel fiber concrete

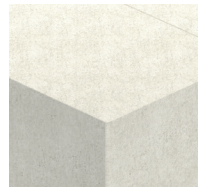

Solid sand-lime brick

### Approvals



ETA-19/0520  
for cracked concrete



ESR-2948  
See ICC-ES  
Evaluation Report  
at www.icc-es.org



aBG steel fiber  
concrete



APPROVED  
from M10



M8 - M20



Seismic C2



ZTV



RWS  
1.350°C



Fire resistance  
classification  
R120

# FAZ II Plus.

## The power anchor for dynamic applications.

Quick and easy installation for higher efficiency as a perfect alternative to injection systems for dynamic stress.

The new ETA confirms the use of the FAZ II Plus for dynamic loads for diameters M16-M24.

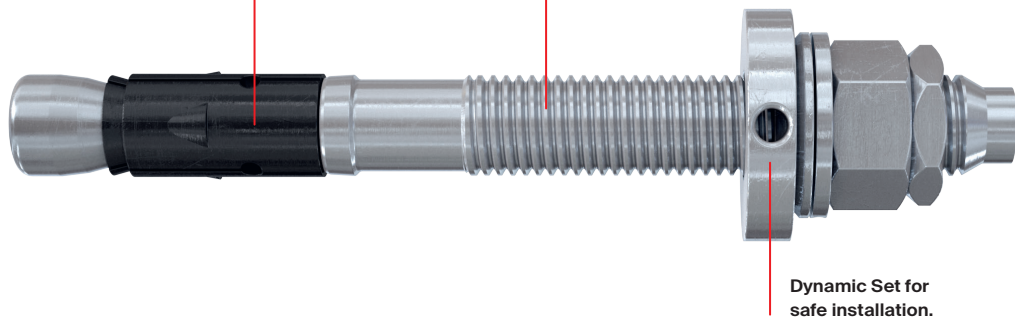

Dynamic Set for safe installation.

### Your advantages at a glance

- The new ETA confirms the use of the FAZ II Plus for dynamic loads for diameters M16-M24 (galvanised steel or stainless steel).
- The fast installation process of the FAZ II Plus provides an efficient fixing solution for dynamic applications with low load cycles with an immediately loadable fixing point.
- Easy and safe installation with Dynamic Set.

### Functioning

- The FAZ II is suitable for pre-positioned and push-through installation.
- For dynamic loads, an additional „dynamic set“ is used, which is filled with injection mortar (compressive strength  $\geq 50\text{N/mm}^2$  e.g.: FIS V, FIS EM Plus, FIS HB or FIS SB) after installation.

### Approvals



ETA-20/0897  
for dynamic load in  
cracked concrete

# Performance features at a glance

## Service life 120 years



### Lasts for eternity:

An external independent assessment confirms the service life of anchorages up to 120 years. Thus, the FAZ II Plus outlasts a whole century and is perfectly suited for large, long-lasting construction projects (M10-M16).

## Seismic applications in earthquake zones



### Always on the safe side with FAZ II Plus:

The FAZ II Plus allows the absorption of high seismic loads of performance category C1 and C2 for diameters M10-M24 with and without the use of the filling disc FFD at installation.

## Dynamic



### Perfect alternative to injection systems for dynamic stress:

The fast installation process of the FAZ II Plus provides an efficient fixing solution for dynamic applications with low load cycles with an immediately loadable fixing point.

## Installation without drill hole cleaning



### The partner for fast installations:

The ETA covers the use of hollow drills and diamond core bits. An expert opinion regulates the assembly without drill hole cleaning (M8-M24). This simplifies installation and speeds up the process for efficiency on the construction site.

## Variable embedment depths

Enables most accurate adaption on the loads (M6 - M20).

### 1. Maximum load with 60 mm embedment depth FAZ II Plus 10 R

- Maximum permissible tension load of 6,2 kN and shear load of 15,1 kN.

### 2. Fast installation thanks to minimum embedment depth FAZ II Plus 10 R

- 40 mm embedment depth = permissible tension load of 4,1 kN and shear load of 10,8 kN.

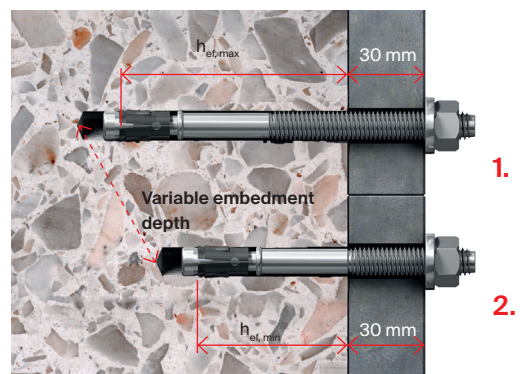



# FiXperience. Safe and reliable.

The fischer design Software FiXperience gives you safe and reliable support in dimensioning your projects whether you are a planner, structural engineer or craftsman. FiXperience is set up modularly

and useable for a variety of applications. The program includes an engineering software with special application modules:



**C-FIX**  
The anchor design program for steel and bonded anchor in concrete, as well as injection systems for masonry. Now with the new FEM design tool for the realistic design of anchorages.



**MORTAR-FIX**  
To determine the injection resin volume for bonded anchors in concrete and masonry.



**WOOD-FIX**  
For the calculation of on-rafter insulation systems and joints in structural timber engineering.



**RAIL-FIX**  
For the design of fixings for railings on reinforced concrete slabs and staircases.



**INSTALL-FIX**  
For the design and dimensioning of MEP installation systems.



**FACADE-FIX**  
For the design of façade fixings with timber sub-structure.



**REBAR-FIX**  
For the design of post-installed rebars in reinforced concrete.



**CHANNEL-FIX**  
For the design of cast-in channels and inserts.



**Electronic planner folder**  
All important documents and records from fischer in one program.

Register on the **myfischer portal** to use **FiXperience online** or **download FiXperience** for free.

# Installation

## Mounting FAZ II Plus in concrete

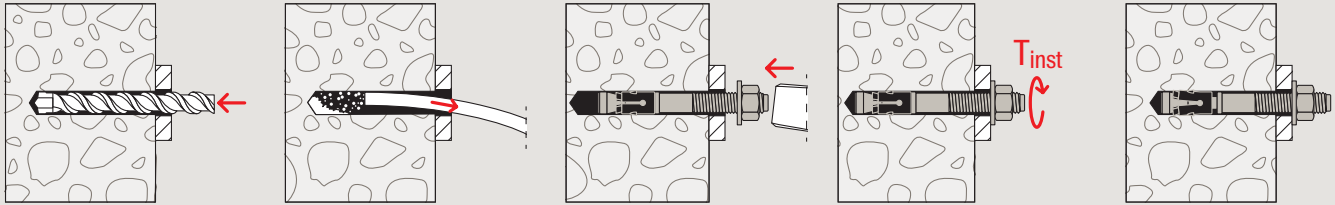

## Push trough installation of the cup nut version with setting gauge

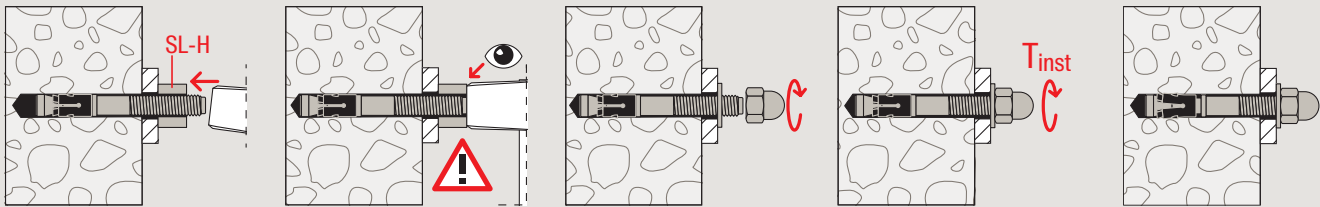

## Mounting without drill hole cleaning

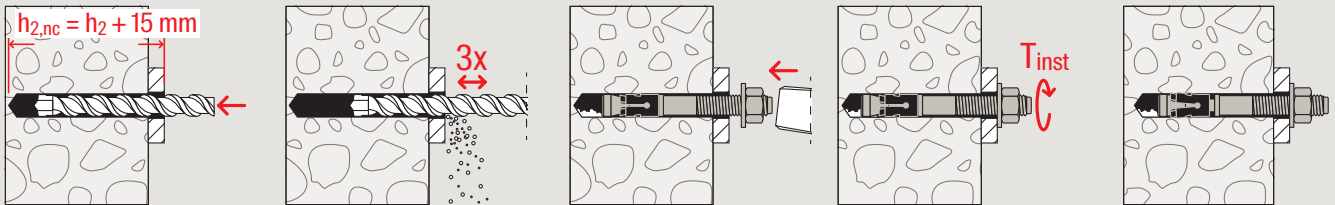

## Mounting with Dynamic Set

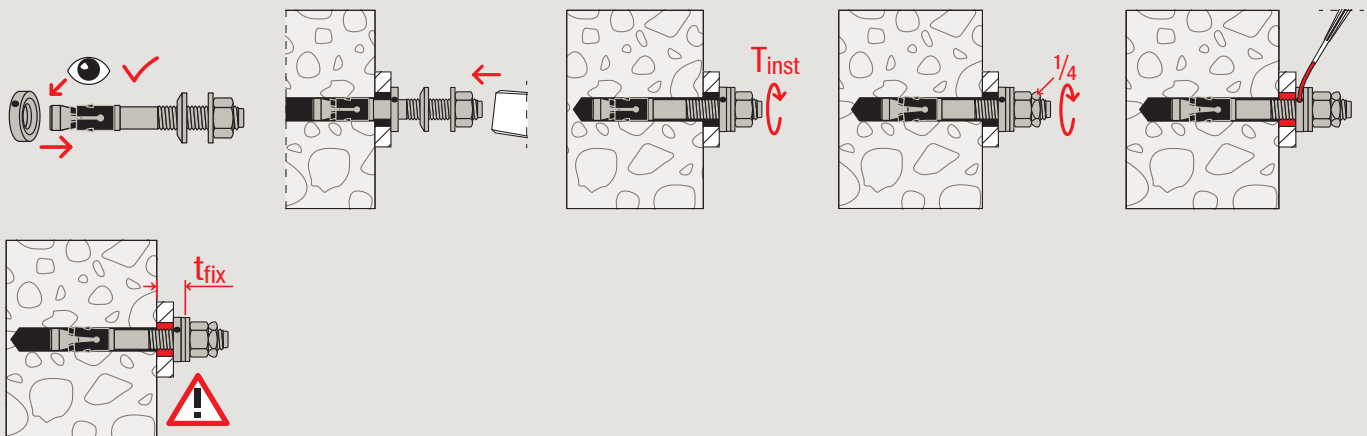

# Applications

## Design examples

### Processing of thin or slim components, balcony railings under thin concrete plate

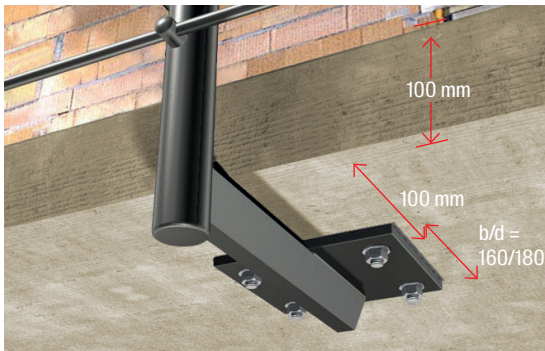

#### Basic conditions

- Fixing to the underside of the balcony
- Rail load 0.5 kN/m
- Length of balcony 2.500 mm
- Rail height 1.000 mm
- Post distance 1.000 mm
- Each anchor plate 4 pieces FAZ II Plus 10/10 K R

### Installation of cable trays with suspended supports

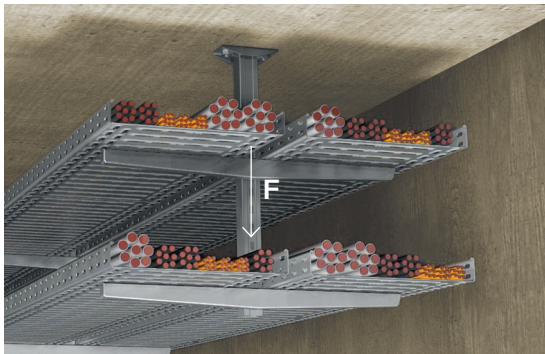

#### Basic conditions

- Cable trays
- Distance between anchors 120 mm
- Distance between the suspended supports 2500 mm
- Anchor plate 60 x 150 mm
- Thickness of concrete ceiling 100 mm
- Each anchor plate 2 pieces FAZ II Plus 10/10 K

# Applications



FAZ II Plus with dynamic loads  
(M16-M24).

## Dynamic applications



Elevator



Lifting platform



Conveyor belt



FAZ II Plus standard version with nut and washer  
made of galvanised steel for indoor use.

## Pipeline installation

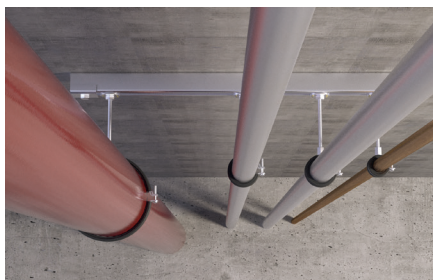

Pipe suspensions

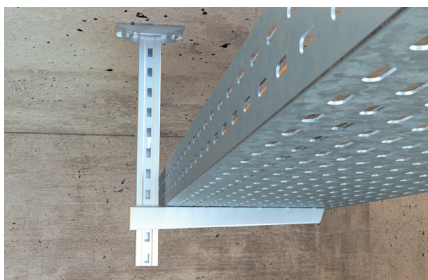

Cable trays



FAZ II Plus made of stainless steel R  
for outdoor use with or without cap nut.



Cap nut version in stainless steel  
for outdoor use.

## Railing fixings



Railing anchorages





FAZ II Plus GS version with large stainless steel washer for substructures with slotted holes outdoors.

**Facade construction**



Facade substructures

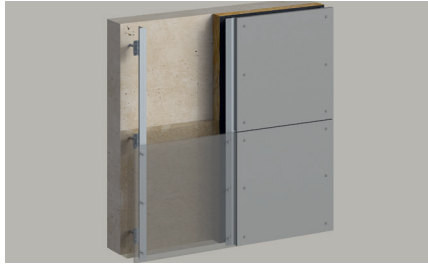

Rainscreen facades

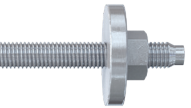

FAZ II Plus HBS Version gvz. with large washer according to timber construction standard DIN 1052.

**Wood construction**



Sleeper anchorages



Canopy on wall



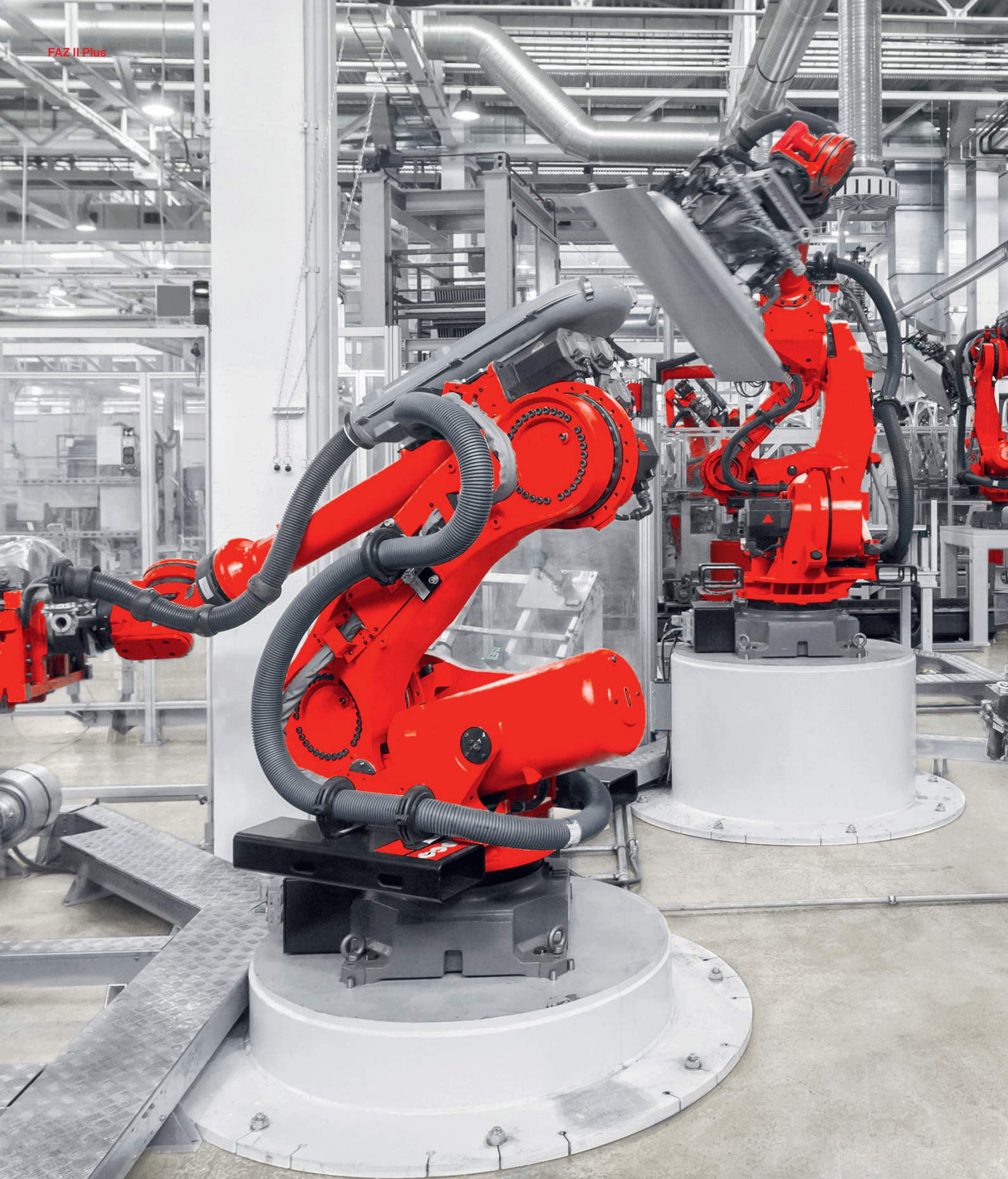

**Dynamic  
fixing solutions.**

The appropriate system for every application.

[www.fischer-international.com](http://www.fischer-international.com)

# Assortment

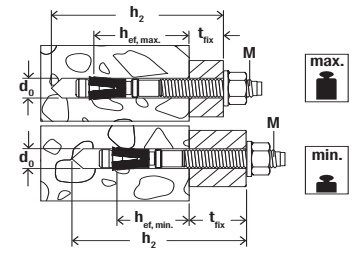

Bolt anchor FAZ II Plus (Standard version)



Bolt anchor FAZ II Plus

Item	Art.-No.			Approval			Drill diameter $d_0$ [mm]	Min. drill hole depth for push-through installation $h_2$ [mm]	Anchor length $l$ [mm]	Standard embedment depth with respective usable length <sup>3)</sup>		Minimum embedment depth with respective usable length		Thread $\varnothing$ x length [mm]	Sales unit [pcs]
	Steel, zinc-plated gvz	stainless steel R	highly corrosion-resistant steel HCR	ETA	ICC	Seismic C1/C2 <sup>1)</sup>				$h_{ef,stand.}$ [mm]	$t_{fix}$ [mm]	$h_{ef,min}$ [mm]	$t_{fix}$ [mm]		
FAZ II Plus 6/10	564572	564607	—	●	—	—	6	60	65	40	10	—	—	M 6 x 25	50
FAZ II Plus 6/20	564573	564608	—	●	—	—	6	70	75	40	20	—	—	M 6 x 35	50
FAZ II Plus 8/10	564574	564609	—	●	●	C1	8	68	75	45	10	35 <sup>2)</sup>	20	M 8 x 38	50
FAZ II Plus 8/10	—	—	564635	●	●	C1	8	68	75	45	10	35 <sup>2)</sup>	20	M 8 x 38	10
FAZ II Plus 8/30	564575	564610	—	●	●	C1	8	88	95	45	30	35 <sup>2)</sup>	40	M 8 x 58	50
FAZ II Plus 8/30	—	—	564636	●	●	C1	8	88	95	45	30	35 <sup>2)</sup>	40	M 8 x 58	10
FAZ II Plus 8/50	564576	564611	564637	●	●	C1	8	108	115	45	50	35 <sup>2)</sup>	60	M 8 x 78	50
FAZ II Plus 8/100	564577	—	—	●	●	C1	8	158	165	45	100	35 <sup>2)</sup>	110	M 8 x 128	25
FAZ II Plus 8/160	564578	—	—	●	●	C1	8	218	225	45	160	35 <sup>2)</sup>	170	M 8 x 100	20
FAZ II Plus 10/10	564579	564612	—	●	●	C1/C2	10	85	95	60	10	40	30	M 10 x 53	50
FAZ II Plus 10/10	—	—	564638	●	●	C1/C2	10	85	95	60	10	40	30	M 10 x 53	10
FAZ II Plus 10/20	564580	—	—	●	●	C1/C2	10	95	105	60	20	40	40	M 10 x 63	25
FAZ II Plus 10/20	—	564613	—	●	●	C1/C2	10	95	105	60	20	40	40	M 10 x 63	50
FAZ II Plus 10/30	564581	—	—	●	●	C1/C2	10	105	115	60	30	40	50	M 10 x 73	25
FAZ II Plus 10/30	—	564614	—	●	●	C1/C2	10	105	115	60	30	40	50	M 10 x 73	50
FAZ II Plus 10/30	—	—	564639	●	●	C1/C2	10	105	115	60	30	40	50	M 10 x 73	10
FAZ II Plus 10/50	564582	564615	—	●	●	C1/C2	10	125	135	60	50	40	70	M 10 x 93	20
FAZ II Plus 10/70	—	564616	—	●	●	C1/C2	10	145	155	60	70	40	90	M 10 x 113	20
FAZ II Plus 10/80	564583	—	—	●	●	C1/C2	10	155	165	60	80	40	100	M 10 x 123	20
FAZ II Plus 10/100	564584	564617	—	●	●	C1/C2	10	175	185	60	100	40	120	M 10 x 143	20
FAZ II Plus 10/160	564585	564618	—	●	●	C1/C2	10	235	245	60	160	40	180	M 10 x 193	20
FAZ II Plus 12/10	564586	564619	—	●	●	C1/C2	12	98	110	70	10	50	30	M 12 x 61	20
FAZ II Plus 12/10	—	—	564640	●	●	C1/C2	12	98	110	70	10	50	30	M 12 x 61	10
FAZ II Plus 12/20	564587	564620	—	●	●	C1/C2	12	109	120	70	20	50	40	M 12 x 71	20
FAZ II Plus 12/30	564588	564621	—	●	●	C1/C2	12	119	130	70	30	50	50	M 12 x 81	20
FAZ II Plus 12/30	—	—	564641	●	●	C1/C2	12	119	130	70	30	50	50	M 12 x 81	10
FAZ II Plus 12/50	564589	564622	—	●	●	C1/C2	12	139	150	70	50	50	70	M 12 x 101	20
FAZ II Plus 12/60	—	564623	—	●	●	C1/C2	12	149	160	70	60	50	80	M 12 x 111	20
FAZ II Plus 12/80	564590	—	—	●	●	C1/C2	12	169	180	70	80	50	100	M 12 x 131	20
FAZ II Plus 12/100	564591	564624	—	●	●	C1/C2	12	189	200	70	100	50	120	M 12 x 151	20
FAZ II Plus 12/160	564592	—	—	●	●	C1/C2	12	249	260	70	160	50	180	M 12 x 186	10

<sup>1)</sup> Only with maximum embedment depth

<sup>2)</sup> With minimum embedment depth only for statically indeterminate systems

<sup>3)</sup> Maximum anchorage depth see ETA

# Assortment

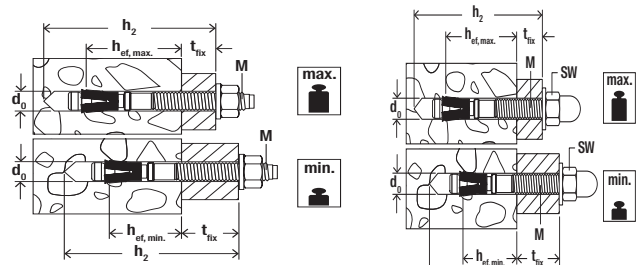

Bolt anchor FAZ II Plus (Standard version) / Bolt anchor FAZ II Plus H (version with cap nut)



Bolt anchor FAZ II Plus

Bolt anchor FAZ II Plus H

Item	Art.-No.			Approval			Drill diameter $d_0$ [mm]	Min. drill hole depth for push-through installation $h_2$ [mm]	Anchor length $l$ [mm]	Standard embedment depth with respective usable length <sup>3)</sup>		Min. anchoring depth with related working length		Thread $\emptyset \times$ length [mm]	Sales unit [pcs]
	Steel, zinc-plated gvz	Stainless steel R	Highly corrosion-resistant steel HCR	ETA	ICC	Seismic C1/C2 <sup>1)</sup>				$h_{ef,stand.}$ [mm]	$t_{fix}$ [mm]	$h_{ef,min}$ [mm]	$t_{fix}$ [mm]		
FAZ II Plus 12/160	—	564625	—	●	●	C1/C2	12	249	260	70	160	50	180	M 12 x 186	20
FAZ II Plus 12/200	564593	—	—	●	●	C1/C2	12	289	300	70	200	50	220	M 12 x 186	10
FAZ II Plus 16/5	564594	—	—	●	●	C1/C2	16	113	128	85	5	65	25	M 16 x 64	10
FAZ II Plus 16/5	—	564626	—	●	●	C1/C2	16	113	128	85	5	65	25	M 16 x 64	20
FAZ II Plus 16/25	—	564627	—	●	●	C1/C2	16	133	148	85	25	65	45	M 16 x 84	10
FAZ II Plus 16/25	564595	—	—	●	●	C1/C2	16	133	148	85	25	65	45	M 16 x 84	10
FAZ II Plus 16/25	—	—	564642	●	●	C1/C2	16	133	148	85	25	65	45	M 16 x 84	10
FAZ II Plus 16/50	564596	—	564643	●	●	C1/C2	16	158	173	85	50	65	70	M 16 x 109	10
FAZ II Plus 16/50	—	564628	—	●	●	C1/C2	16	158	173	85	50	65	70	M 16 x 109	20
FAZ II Plus 16/60	—	564629	—	●	●	C1/C2	16	168	183	85	60	65	80	M 16 x 119	20
FAZ II Plus 16/100	564597	564630	—	●	●	C1/C2	16	208	223	85	100	65	120	M 16 x 159	10
FAZ II Plus 16/160	564598	—	—	●	●	C1/C2	16	268	283	85	160	65	180	M 16 x 189	10
FAZ II Plus 16/200	564599	—	—	●	●	C1/C2	16	308	323	85	200	65	220	M 16 x 189	10
FAZ II Plus 16/250	564600	—	—	●	●	C1/C2	16	358	373	85	250	65	270	M 16 x 100	10
FAZ II Plus 16/300	564601	—	—	●	●	C1/C2	16	408	423	85	300	65	320	M 16 x 100	10
FAZ II Plus 20/30	564602	—	—	●	●	C1/C2	20	160	172	100	30	—	—	M 20 x 54	5
FAZ II Plus 20/30	—	564631	—	●	●	C1/C2	20	160	172	100	30	—	—	M 20 x 54	4
FAZ II Plus 20/60	564603	—	—	●	●	C1/C2	20	190	202	100	60	—	—	M 20 x 84	5
FAZ II Plus 20/60	—	564632	—	●	●	C1/C2	20	190	202	100	60	—	—	M 20 x 84	4
FAZ II Plus 20/160	564604	—	—	●	●	C1/C2	20	290	302	100	160	—	—	M 20 x 100	5
FAZ II Plus 24/30	564605	—	—	●	●	C1/C2	24	189	205	125	30	—	—	M 24 x 58	5
FAZ II Plus 24/30	—	564633	—	●	●	C1/C2	24	189	205	125	30	—	—	M 24 x 58	4
FAZ II Plus 24/60	564606	—	—	●	●	C1/C2	24	219	235	125	60	—	—	M 24 x 88	5
FAZ II Plus 24/60	—	564634	—	●	●	C1/C2	24	219	235	125	60	—	—	M 24 x 88	4
FAZ II Plus 10/10 H	564687	564691	—	●	—	C1/C2	10	85	95	60	10	40	30	M 10 x 53	20
FAZ II Plus 10/20 H	564688	564692	—	●	—	C1/C2	10	95	105	60	20	40	40	M 10 x 63	20
FAZ II Plus 12/10 H	564689	564693	—	●	—	C1/C2	12	99	109	70	10	50	30	M 12 x 61	20
FAZ II Plus 12/20 H	564690	564694	—	●	—	C1/C2	12	109	119	70	20	50	40	M 12 x 71	20

<sup>1)</sup> Only with maximum embedment depth

<sup>2)</sup> With minimum embedment depth only for statically indeterminate systems

<sup>3)</sup> Maximum anchorage depth see ETA

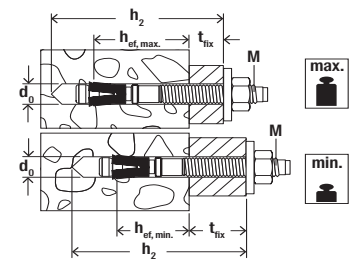

Bolt anchor FAZ II Plus GS (with large washer) / Bolt anchor FAZ II Plus HBS (washer compliant to timber construction standard DIN 1052)



Bolt anchor FAZ II Plus GS

Bolt anchor FAZ II Plus HBS

Item	Art.-No.		Approval		Drill diameter $d_0$ [mm]	Min. drill hole depth for push-through installation $h_2$ [mm]	Anchor length $l$ [mm]	Standard embedment depth with respective usable length <sup>3)</sup>		Minimum embedment depth with respective usable length		Thread $\emptyset$ x length [mm]	Washer (outer diameter x thickness) [mm]	Sales unit [pcs]
	Steel, zinc-plated gvz	Stainless steel R	ETA	Seismic C1/C2 <sup>1)</sup>				$h_{ef,stand.}$ [mm]	$t_{fix}$ [mm]	$h_{ef,min}$ [mm]	$t_{fix}$ [mm]			
FAZ II Plus 8/10 GS	564644	564663	●	C1	8	68	75	45	10	35 <sup>2)</sup>	20	M 8 x 38	22 x 2.5	50
FAZ II Plus 8/30 GS	564645	564664	●	C1	8	88	95	45	30	35 <sup>2)</sup>	40	M 8 x 58	22 x 2.5	50
FAZ II Plus 10/10 GS	564646	564665	●	C1/C2	10	85	95	60	10	40	30	M 10 x 53	25 x 3	50
FAZ II Plus 10/30 GS	564647	—	●	C1/C2	10	105	115	60	30	40	50	M 10 x 73	25 x 3	25
FAZ II Plus 10/30 GS	—	564666	●	C1/C2	10	105	115	60	30	40	50	M 10 x 73	25 x 3	50
FAZ II Plus 12/10 GS	564648	564667	●	C1/C2	12	99	110	70	10	50	30	M 12 x 61	30 x 3	20
FAZ II Plus 12/20 GS	564649	—	●	C1/C2	12	109	120	70	20	50	40	M 12 x 71	30 x 3	20
FAZ II Plus 12/30 GS	564650	564668	●	C1/C2	12	119	130	70	30	50	50	M 12 x 81	30 x 3	20
FAZ II Plus 12/50 GS	564651	—	●	C1/C2	12	139	150	70	50	50	70	M 12 x 101	30 x 3	20
FAZ II Plus 12/80 GS	564652	—	●	C1/C2	12	169	180	70	80	50	100	M 12 x 131	44 x 4	20
FAZ II Plus 12/100 GS	564653	—	●	C1/C2	12	189	200	70	100	50	120	M 12 x 151	30 x 3	20
FAZ II Plus 12/100 GS	564654	—	●	C1/C2	12	189	200	70	100	50	120	M 12 x 151	44 x 4	20
FAZ II Plus 12/120 GS	564655	—	●	C1/C2	12	209	220	70	120	50	140	M 12 x 171	44 x 4	20
FAZ II Plus 12/120 GS	564656	—	●	C1/C2	12	209	220	70	120	50	140	M 12 x 171	30 x 3	20
FAZ II Plus 12/140 GS	564657	—	●	C1/C2	12	229	240	70	140	50	160	M 12 x 186	44 x 4	20
FAZ II Plus 12/160 GS	564658	—	●	C1/C2	12	249	260	70	160	50	180	M 12 x 186	44 x 4	20
FAZ II Plus 12/160 GS	—	564669	●	C1/C2	12	249	260	70	160	50	180	M 12 x 186	44 x 4	20
FAZ II Plus 12/180 GS	564659	—	●	C1/C2	12	269	280	70	180	50	200	M 12 x 186	44 x 4	20
FAZ II Plus 12/200 GS	564660	—	●	C1/C2	12	289	300	70	200	50	220	M 12 x 186	44 x 4	20
FAZ II Plus 16/160 GS	564661	—	●	C1/C2	16	269	283	85	160	65	180	M 16 x 189	56 x 5	10
FAZ II Plus 16/160 GS	—	564670	●	C1/C2	16	269	283	85	160	65	180	M 16 x 100	56 x 5	4
FAZ II Plus 16/200 GS	564662	—	●	C1/C2	16	308	323	85	200	65	220	M 16 x 189	56 x 5	10
FAZ II Plus 12/100 HBS	564683	—	●	C1/C2	12	189	205	70	100	50	120	M 12 x 151	58 x 6	20
FAZ II Plus 12/120 HBS	564684	—	●	C1/C2	12	209	225	70	120	50	140	M 12 x 171	58 x 6	20
FAZ II Plus 16/160 HBS	564685	—	●	C1/C2	16	268	278	85	160	65	180	M 16 x 189	68 x 6	10
FAZ II Plus 16/200 HBS	564686	—	●	C1/C2	16	308	328	85	200	65	220	M 16 x 189	68 x 6	10

<sup>1)</sup> Only with maximum embedment depth

<sup>2)</sup> With minimum embedment depth only for statically indeterminate systems

<sup>3)</sup> Maximum anchorage depth see ETA

# Assortment

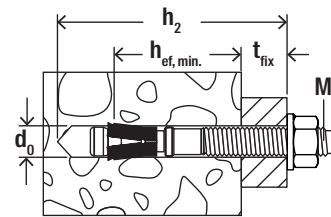

Bolt anchor FAZ II Plus K / Bolt anchor FAZ II Plus K GS (short version)



Bolt anchor FAZ II Plus K

Bolt anchor FAZ II Plus K / FAZ II Plus K GS

Item	Art.-No.		Approval		Drill diameter		Anchor length l [mm]	Minimum embedment depth with respective usable length		Thread Ø x length [mm]	Washer (outer diameter x thickness) [mm]	Sales unit [pcs]
	Steel, zinc-plated gvz	Stainless steel R	ETA	Seismic C1/C2 <sup>1)</sup>	d <sub>0</sub> [mm]	h <sub>2</sub> [mm]		h <sub>ef,min</sub> [mm]	t <sub>fix</sub> [mm]			
FAZ II Plus 8/5 K	564671	564676	●	C1	8	53	60	35 <sup>1)</sup>	5	M 8 x 23	16 x 1.6	50
FAZ II Plus 10/10 K	564672	564677	●	C1/C2	10	65	75	40	10	M 10 x 33	20 x 2.0	50
FAZ II Plus 10/20 K	564673	—	●	C1/C2	10	75	85	40	20	M 10 x 43	20 x 2.0	25
FAZ II Plus 10/20 K	—	564678	●	C1/C2	10	75	85	40	20	M 10 x 43	20 x 2.0	50
FAZ II Plus 12/10 K	564674	564679	●	C1/C2	12	79	90	50	10	M 12 x 41	24 x 2.5	20
FAZ II Plus 12/20 K	564675	564680	●	C1/C2	12	89	100	50	20	M 12 x 51	24 x 2.5	20
FAZ II Plus 10/10 K GS	564681	—	●	C1/C2	10	65	75	40	10	M 10 x 33	25 x 3.0	50
FAZ II Plus 12/10 K GS	564681	—	●	C1/C2	12	79	90	50	10	M 12 x 41	30 x 3.0	20

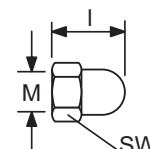

Cap nut FAZ II Plus



Cap nut FAZ II Plus

Item	Art.-No.		Approval	Thread Ø x length [mm]	Cap nut height [mm]	Key width (SW) [mm]	Sales unit [pcs]
	Steel, zinc-plated gvz	Stainless steel R					
Cap nut FAZ II Plus M10 <sup>1)</sup>	569126	569127	●	M 10	23	17	20
Cap nut FAZ II Plus M12 <sup>1)</sup>	569128	569129	●	M 12	29	19	20

1) Can be combined with all bolt anchors FAZ II M10 and M12 in accordance with approval.

Accessories



Filling disk FFD



Bolt anchor-Setting tool FABS



Bolt anchor-Setting tool FA-ST II



Bolt anchor-Setting tool FA-ST II set

Item	Art.-No.	Inner-Ø [mm]	Outer-Ø [mm]	Contents [pcm]	Match	Sales unit [pcs]
FFD 26x12x6	538458	12	26	-	FAZ II Plus M8/M10	4
FFD 26x12x6 R	541986	12	26	-	FAZ II Plus M8/M10 R	4
FFD 30x14x6	538459	14	30	-	FAZ II Plus M12	4
FFD 30x14x6 R	541987	14	30	-	FAZ II Plus M12 R	4
FFD 38x19x7	538460	19	38	-	FAZ II Plus M16	4
FFD 38x19x7 R	541988	19	40	-	FAZ II Plus M16 R	4
FFD 46x23x8	538461	23	46	-	FAZ II Plus M20	4
FFD 46x23x8 R	541989	23	50	-	FAZ II Plus M20 R	4
FFD 54x28x10	538462	28	54	-	FAZ II Plus M24	4
FFD 55x28x10 R	541990	28	55	-	FAZ II Plus M24 R	4
FABS	077937	-	-	-	FAZ II Plus for diameter from M6 up to M12	1
FA-ST II M10	558790	-	-	SDS adapter; socket SW 17	FAZ II Plus M10	1
FA-ST II M12	558791	-	-	SDS adapter; socket SW 19	FAZ II Plus M12	1
FA-ST II M16	558792	-	-	SDS adapter; socket SW 24	FAZ II Plus M16	1
FA-ST II Set	558789	-	-	SDS adapter; je 1x socket SW 17, SW 19, SW 24	FAZ II Plus M10/M12/M16	1

fischer filling disc FFD

Optional e.g. for use under seismic loads C2 or to minimise the hole clearance:

The annular gap between bolt and attachment may be filled with mortar compressive strength  $\geq 50 \text{ N/mm}^2$  e.g. FIS V Plus, FIS EM Plus, FIS HB and FIS SB. The backfilling disc would be used in addition to the standard washer to be used. The thickness of the backfill disc must be taken into account for  $t_{fix}$ . The counterbore in the filling disk must point in the direction of the attachment part.

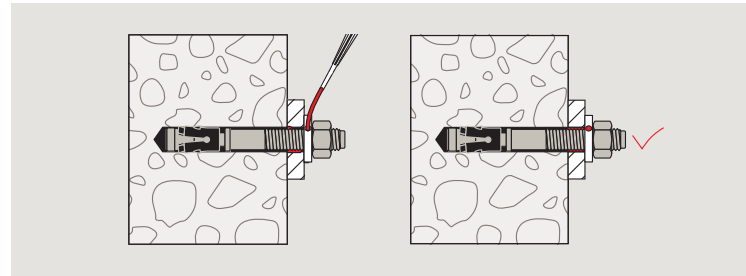

Dynamic Set

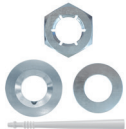

Dynamic Set

Item	Art.-No.	Outer-Ø [mm]	Thickness dynamic set	Min. fixture thickness $t_{fix}$	Match	Sales unit [pcs]
Dynamic Set M16	568785	38	11	15	FAZ II Plus M16	10
Dynamic Set M20	568786	46	13	20	FAZ II Plus M20	10
Dynamic Set M24	568787	54	17	24	FAZ II Plus M24	10
Dynamic Set M16 R	568788	40	11	15	FAZ II Plus M16 R	10
Dynamic Set M20 R	568789	50	13	20	FAZ II Plus M20 R	10
Dynamic Set M24 R	568790	55	17	24	FAZ II Plus M24 R	10

# Loads

## Bolt anchor FAZ II Plus

Permissible loads of a single anchor<sup>1)</sup> in normal concrete of strength class C20/25.

For the design the complete current assessment ETA-19/0520 of 21.02.2022 has to be considered.

Type	Material/ surface <sup>2)</sup>	Effective anchorage depth $h_{ef}$ [mm]	Minimum member thickness $h_{min}$ [mm]	Instal- lation torque $T_{inst}$ [Nm]	Cracked concrete				Non-cracked concrete			
					Permissible tension ( $N_{perm}$ ) and shear loads ( $V_{perm}$ ); minimum spacing ( $s_{min}$ ) and edge distances ( $c_{min}$ ) with reduced loads				Permissible tension ( $N_{perm}$ ) and shear loads ( $V_{perm}$ ); minimum spacing ( $s_{min}$ ) and edge distances ( $c_{min}$ ) with reduced loads			
					$N_{perm}^{3)}$ [kN]	$V_{perm}^{3)}$ [kN]	$s_{min}^{3)}$ [mm]	$c_{min}^{3)}$ [mm]	$N_{perm}^{3)}$ [kN]	$V_{perm}^{3)}$ [kN]	$s_{min}^{3)}$ [mm]	$c_{min}^{3)}$ [mm]
FAZ II Plus 6	gvz	40	80	8	0.7	4.3	35	40	5.0	4.3	35	40
	gvz	80	120	8	0.7	4.3	35	40	5.0	4.3	35	40
	R	40	80	8	0.7	5.0	35	40	5.0	5.0	35	40
	R	80	120	8	0.7	5.0	35	40	5.0	5.0	35	40
FAZ II Plus 8	gvz	35	80	20	2.6	8.5	35	40	4.8	9.3	40	40
	gvz	90	140	20	3.8	9.3	35	40	6.7	9.3	40	40
	R	35	80	20	2.6	8.5	35	40	4.8	10.1	40	40
	R	90	140	20	3.8	10.1	35	40	6.7	10.1	40	40
FAZ II Plus 10	gvz	40	80	45	4.1	10.8	40	45	5.9	15.0	40	45
	gvz	100	150	45	6.2	15.0	40	45	9.5	15.0	40	45
	R	40	80	45	4.1	10.8	40	45	5.9	15.1	40	45
	R	100	150	45	6.2	15.1	40	45	9.5	15.1	40	45
FAZ II Plus 12	gvz	50	100	60	5.8	18.0	50	55	8.3	21.1	50	55
	gvz	125	190	60	9.5	21.1	50	55	10.5	21.1	50	55
	R	50	100	60	5.8	18.0	50	55	8.3	24.1	50	55
	R	125	190	60	9.5	24.1	50	55	10.5	24.1	50	55
FAZ II Plus 16	gvz	65	140	110	8.6	27.5	65	65	12.3	39.1	65	65
	gvz	160	240	110	12.9	39.1	65	65	18.4	39.1	65	65
	R	65	140	110	8.6	27.5	65	65	12.3	39.3	65	65
	R	160	240	110	12.9	40.6	65	65	18.4	40.6	65	65
FAZ II Plus 20	gvz	100	160	200	16.4	47.4	95	85	23.4	47.4	95	95
	gvz	180	270	200	16.4	47.4	95	85	23.4	47.4	95	95
	R	100	160	200	16.4	52.5	95	85	23.4	61.7	95	95
	R	180	270	200	16.4	61.7	95	85	23.4	61.7	95	95
FAZ II Plus 24	gvz	125	200	270	22.9	73.3	100	100	32.7	73.3	100	135
	R	125	200	270	22.9	73.3	100	100	32.7	90.3	100	135

<sup>1)</sup> Design according to EN 1992-4:2018 (for static resp. quasi-static loads). The partial safety factors for material resistance as regulated in the ETA as well as a partial safety factor for load actions of  $\gamma_L = 1.4$  are considered. As a single anchor counts e.g. an anchor with a spacing  $s \geq 3 \times h_{ef}$  and an edge distance  $c \geq 1.5 \times h_{ef}$ . Accurate data see ETA.

<sup>2)</sup> Further steel grades, versions and technical data see ETA, e.g. for dry internal conditions, galvanised steel (gvz); for damp interiors and for outdoor use, stainless steel (R).

<sup>3)</sup> In the case of combinations of tension and shear loads, bending moments with reduced or minimum spacing and edge distances (anchor groups), the design must be carried out in accordance with the provisions of the complete ETA and the provisions of the EN 1992-4:2018. We recommend using our anchor design software C-FIX.



**Bolt anchor FAZ II Plus dynamic**

Design values for cyclic fatigue loading<sup>1)</sup> of a single anchor in cracked or non-cracked normal concrete of strength class C20/25<sup>2)</sup>.  
For the design the complete current assessment ETA-20/0897 of 20.12.2022 has to be considered.

Type	Material/ surface	Effective ancho- rage depth  $h_{ef}$ [mm]	Mini- mum member thick- ness  $h_{min}$ [mm]	Instal- lation torque  $T_{inst}$ [Nm]	Cracked concrete				Non-cracked concrete			
					Design values of tension ( $\Delta N_{Ed,max}$ ) and shear loads ( $\Delta V_{Ed,max}$ ); minimum spacing ( $s_{min}$ ) and edge distances ( $c_{min}$ ) with reduced loads				Design values of tension ( $\Delta N_{Ed,max}$ ) and shear loads ( $\Delta V_{Ed,max}$ ); minimum spacing ( $s_{min}$ ) and edge distances ( $c_{min}$ ) with reduced loads			
					$\Delta N_{Ed,max}$ <sup>3)</sup> [kN]	$\Delta V_{Ed,max}$ <sup>3)</sup> [kN]	$s_{min}$ <sup>3)</sup> [mm]	$c_{min}$ <sup>3)</sup> [mm]	$\Delta N_{Ed,max}$ <sup>3)</sup> [kN]	$\Delta V_{Ed,max}$ <sup>3)</sup> [kN]	$s_{min}$ <sup>3)</sup> [mm]	$c_{min}$ <sup>3)</sup> [mm]
<b>FAZ II Plus 16</b>	gvz	65	140	110	6.0	4.7	65	65	6.4	4.7	65	65
	gvz	85	140	110	6.4	4.7	65	65	6.4	4.7	65	65
	gvz	160	240	110	6.4	4.7	65	65	6.4	4.7	65	65
	R	65	140	110	3.1	6.0	65	65	3.1	6.0	65	65
	R	85	140	110	3.1	6.0	65	65	3.1	6.0	65	65
	R	160	240	110	3.1	6.0	65	65	3.1	6.0	65	65
<b>FAZ II Plus 20</b>	gvz	100	160	200	8.8	6.1	95	85	8.8	6.1	95	95
	gvz	180	270	200	8.8	6.1	95	85	8.8	6.1	95	95
	R	100	160	200	4.7	9.4	95	85	4.7	9.4	95	95
	R	180	270	200	4.7	9.4	95	85	4.7	9.4	95	95
<b>FAZ II Plus 24</b>	gvz	125	200	270	14.7	9.5	100	100	14.7	9.5	100	135
	R	125	200	270	6.9	13.6	100	100	6.9	13.6	100	135

<sup>1)</sup> The design values of the cyclic fatigue loading apply for load cycles  $> 10^6$  in accordance with design method I acc. to TR061 – for unknown static lower load. If the static lower load is known and / or for lower number of load cycles higher load values are possible. The partial safety factors as regulated in the design standard are considered. As a single anchor counts e.g. an anchor with a spacing  $s \geq 3 \times h_{ef}$ . Drill hole cleaning acc. to assessment.

<sup>2)</sup> For higher concrete strength classes up to C50/60 higher permissible loads may be possible. - see assessment. The concrete is assumed to be standard-reinforced.

<sup>3)</sup> In the case of combinations of tensile loads and shear loads, with reduced or minimum spacing and edge distances (anchor groups) the design must be carried out in accordance with the provisions of the complete assessment.

**fischer hollow drill bit.  
For drilling with low dust  
as well as for efficient and  
approved anchoring.**

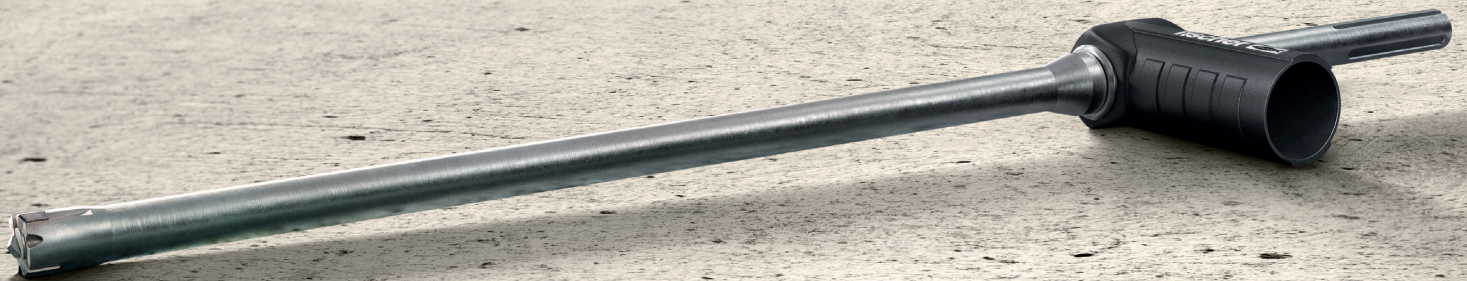

# fischer Service.

## Our 360° service to you.

From software solutions, to training, to personal consulting. As a reliable partner, we are always happy to assist you with words and deeds.



FiXperience

## Design Software FiXperience Suite.

The fischer design Software FiXperience gives you safe and reliable support in measuring your projects whether you are a planner, structural engineer or craftsman. Measuring has never been so simple!

Test it now and download it for free:  
[www.fischer-international.com/fixperience](http://www.fischer-international.com/fixperience)



## fischer PRO. The Mobile Guide to Fixing Solutions for Professionals.

The fischer PRO App is a mobile guide to fixing solutions offering professionals the opportunity to quickly and easily find out about products, identify the right fixing solution through the digital guide and/or find a local dealer. Download now from Apple App Store or Google Play Store.

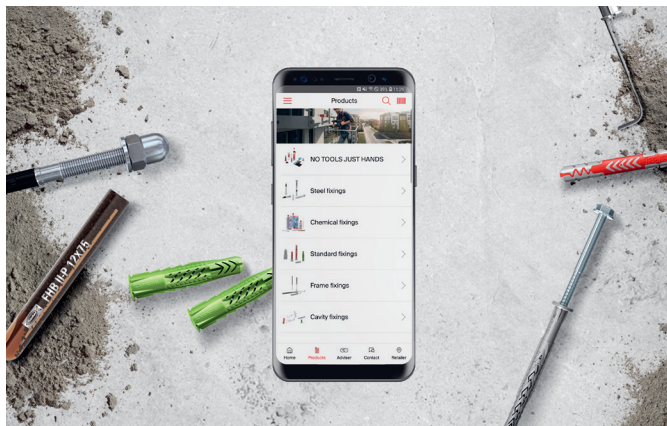

Dealer:

[www.fischer-international.com](http://www.fischer-international.com)



**fischer stands for**

Fixing Systems  
Automotive  
fischertechnik  
Consulting  
Electronic Solutions

---

**fischerwerke GmbH & Co. KG**  
Klaus-Fischer-Straße 1 · 72178 Waldachtal  
Germany  
P +49 7443 12-0  
[www.fischer-international.com](http://www.fischer-international.com) · [info@fischer.de](mailto:info@fischer.de)

---