

# Shower system with single-lever shower mixer without hand shower - Brushed Platinum SERIES SPECIFIC

26 024 661 Product version from 10/1/2023



- shower with fixed riser projection 450mm
- pivotable 180°
- overhead shower: rain flow
- rain shower Ø 300 mm
- rain shower with anti-scale system
- max. rainshower flow 14 l/min
- Function from: 10 l/min
- shower holder with rosette Ø 78mm
- slide-on rosettes Ø 55 mm
- 1500 mm metal shower hose
- height of fittings up to top edge of elbow 2280mm
- height of fittings up to rain shower (bottom edge) 1940mm
- automatic diverter for fixed-riser shower/hand shower
- Pipe diameter 20 mm
- quick clearing
- WRAS

**This article does not include a hand shower!**

**Water carrying concealed rough parts on lower wall fixing.**

**Recommended spacing from bottom edge of shower stem to floor 92 mm.**



**Intrinsic protection against back flow.**

This article does not include a hand shower!

Water carrying concealed rough parts on lower wall fixing.

Recommended spacing from bottom edge of shower stem to floor 92 mm.

Intrinsic protection against back flow.

	Brushed Platinum	26 024 661-06
	Chrome	26 024 661-00
	Platinum	26 024 661-08
	Dark Chrome	26 024 661-19
	Light Gold (PVD)	26 024 661-26
	Brushed Light Gold (PVD)	26 024 661-27
	Brushed Durabronze (23kt Gold)	26 024 661-28
	Matte Black	26 024 661-33
	Brushed Gold (PVD)	26 024 661-37
	Brushed Dark Brass (PVD)	26 024 661-39
	Brushed Bronze (PVD)	26 024 661-42
	Brushed Dark Bronze (PVD)	26 024 661-43
	Brushed Champagne (22kt Gold)	26 024 661-46
	Champagne (22kt Gold)	26 024 661-47
	Brushed Chrome	26 024 661-93
	Brushed Dark Platinum	26 024 661-99

## Shower system with single-lever shower mixer without hand shower - Brushed Platinum SERIES SPECIFIC

26 024 661 Product version from 10/1/2023

### Required miscellaneous

	<b>Concealed wall mounting -</b> ●min. recess depth 78 mm ●max. recess depth 103 mm	35 003 970 90
---	---	---------------

### Required miscellaneous

	<b>Hand shower - Brushed Platinum</b>	28 015 979-06
---	---------------------------------------	---------------

### Required miscellaneous

	<b>Hand shower 120 mm - Brushed Platinum</b> ●Four settings: COMPACT RAIN, COMPACT SOFT FLOW, COMPACT AQUAPRESSURE FLOW, COMPACT CASCADE, max. flow rate l/min (at 3 bar) ●spray head Ø 120mm ●Hand shower see page {PAGE}	28 012 979-06
---	---	---------------

### Required miscellaneous

	<b>Hand shower FlowReduce 120 mm - Brushed Platinum</b>	28 012 979-06 0010
---	---	-----------------------

### Required miscellaneous

	<b>Hand shower - Brushed Platinum</b>	28 017 979-06
---	---------------------------------------	---------------

### Required miscellaneous

	<b>Hand shower 130 mm - Brushed Platinum</b>	28 016 979-06
---	--	---------------

### Required miscellaneous

	<b>SERIES-VARIOUS Hand shower FlowReduce - Brushed Platinum</b>	28 029 979-06 0010
---	---	-----------------------

### Required miscellaneous

	<b>SERIES-VARIOUS Hand shower FlowReduce - Brushed Platinum</b>	28 025 979-06 0010
---	---	-----------------------

### Required miscellaneous

	<b>Hand shower FlowReduce 100 mm - Brushed Platinum</b>	28 018 979-06 0010
---	---	-----------------------

### Required miscellaneous

	<b>Hand shower 100 mm - Brushed Platinum</b>	28 018 979-06
---	--	---------------

### Required miscellaneous

	<b>Hand shower FlowReduce 130 mm - Brushed Platinum</b>	28 016 979-06 0010
---	---	-----------------------

### Required miscellaneous

	<b>SERIES-VARIOUS Hand shower FlowReduce - Brushed Platinum</b>	28 027 979-06 0010
---	---	-----------------------

**Shower system with single-lever shower mixer without hand shower - Brushed Platinum** SERIES SPECIFIC

26 024 661 Product version from 10/1/2023  
mm [inch]

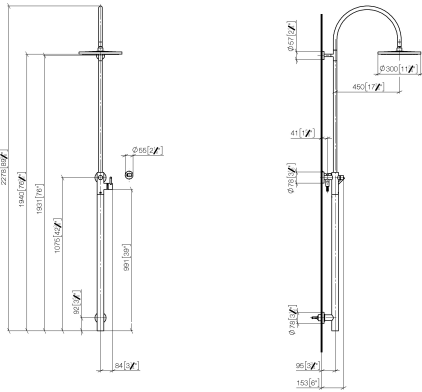

**Flow rate chart**

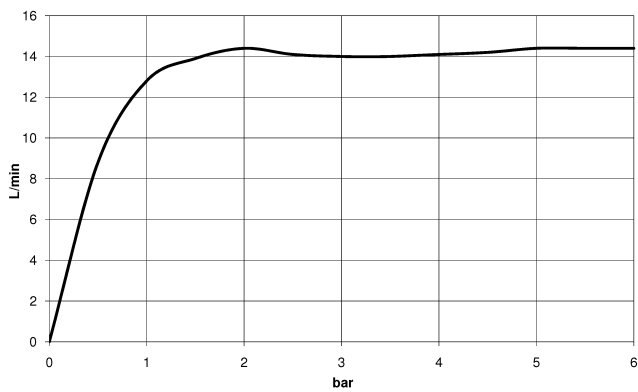

**Codes & Standards**

DIN 4109

EN 1717

ISO 3822

Scottish Water  
Byelaws

UK Water Supply  
Regulations

Ü-Zeichen



Shower system with single-lever shower mixer without hand shower - Brushed Platinum SERIES SPECIFIC

---

26 024 661 Product version from 10/1/2023

Certificates and sustainability

---

Belgaqua\_21-023-2 WRAS\_2212

LGA\_29

EPD-DOR-20230287 Belgaqua\_25-345-2  
-IBA1-EN  
Environmental.prod  
uct-declarat

# Shower system with single-lever shower mixer without hand shower - Brushed Platinum SERIES SPECIFIC

26 024 661 Product version from 10/1/2023

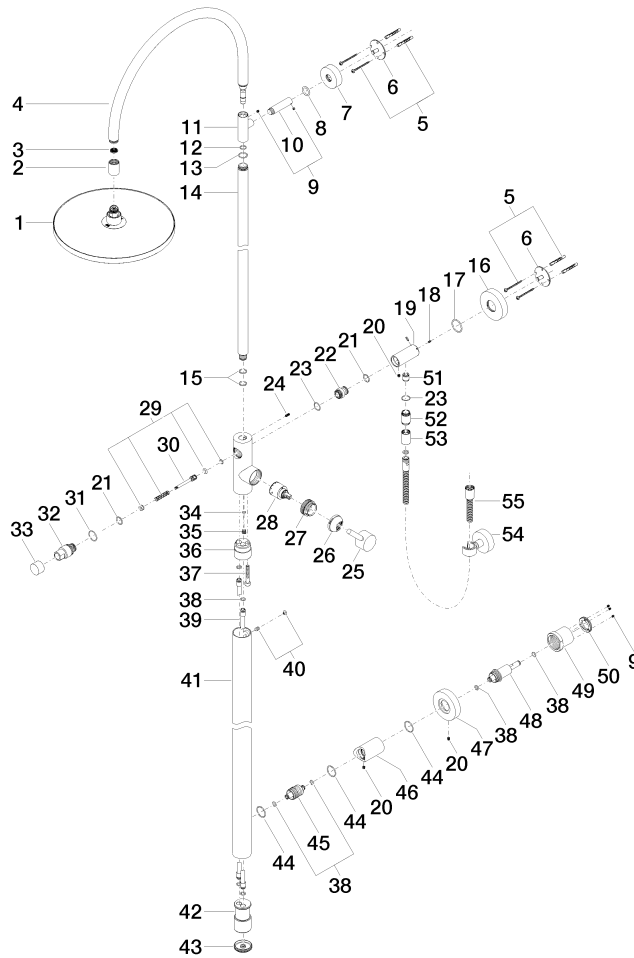

## Spare parts list

No.	Item Number	Name	Quantity used	Delivery time
15	90 14 10 055 00 90	O-Ring EPDM 70 15,0 x 2,0 mm -	2.00	14
47	09 27 88 008-06	Rosette Ø 78 x 18 mm - Brushed Platinum	1.00	-
Spare part can no longer be ordered, please order the replacement item				
17	09 14 10 101 90	O-Ring EPDM 70 30,0 x 2,5 mm -	1.00	14
30	09 31 09 102 20-06	Pull rod for diverter Ø 12 x 70 mm - Brushed Platinum	1.00	-
Spare part can no longer be ordered, please order the replacement item				
45	09 24 04 215 20 90	Nipple Ø 28,5 x 60 mm -	1.00	14
21	90 14 10 010 00 90	O-Ring EPDM 70 17,0 x 2,0 mm -	2.00	14
52	09 24 03 115 20-06	Nipple Ø 22 x 33 mm - Brushed Platinum	1.00	20
54	28 050 920-06	CIRCLE Wall bracket - Brushed Platinum	1.00	-
Spare part can no longer be ordered, please order the replacement item				
8	09 14 10 006 90	O-Ring 18,0 x 3,5 mm -	1.00	14
35	09 31 20 027 10-00	Plug M8 x 1 - Chrome	1.00	20
29	90 16 02 023 00 90	Diverter Repair kit, bath deck mounting 15 x 50 x 15 mm	1.00	14
2	09 24 03 163 20-06	Connection Ø 25 x 32 mm - Brushed Platinum	1.00	20
18	09 31 11 061 90	Mounting Threaded pin with hexagon socket with cup point M4 x 10 mm -	2.00	14
6	09 30 11 103 90	Holder Ø 53 x 19 mm -	2.00	-

## Shower system with single-lever shower mixer without hand shower - Brushed Platinum SERIES SPECIFIC

26 024 661 Product version from 10/1/2023

Spare part can no longer be ordered, please order the replacement item

40	04 31 20 034 00 90	Plug Cover with threaded pin -	1.00	14
49	09 21 02 128 90	Cover/sleeve Clamp sleeve Ø 50 x 46 mm -	1.00	14
37	09 30 30 111 90	Mounting Cylinder head screw with hexagon socket M8 x 50 mm -	1.00	14
34	09 14 10 132 90	O-Ring EPDM 70 6,0 x 1,5 mm -	1.00	14
48	09 24 04 210 10 90	Nipple Ø 33 x 105 mm -	1.00	14
43	09 21 02 132-06	Cover Ø 44 x 8 mm - Brushed Platinum	1.00	-

Spare part can no longer be ordered, please order the replacement item

27	09 24 04 341 90	nut	1.00	82
32	09 21 34 081 20-06	Diverter Ø 30 x 56 mm - Brushed Platinum	1.00	20
25	90 20 66 017 00-06	Handle Lever 52 x 117 x 35 mm - Brushed Platinum	1.00	20
12	90 14 10 077 00 90	O-Ring EPDM 70 12,0 x 2,0 mm -	1.00	14
13	09 14 10 122 90	O-Ring EPDM 70 18,6 x 2,0 mm -	1.00	14
38	09 14 10 139 90	O-Ring EPDM 70 9,0 x 2,0 mm -	6.00	14
20	09 31 11 049 90	Mounting Threaded pin with hexagon socket with cup point M6 x 6 mm -	3.00	14
44	90 14 10 063 00 90	O-Ring EPDM 70 26,0 x 2,0 mm -	3.00	14
26	09 28 30 042-06	Cover Ø 43 x 19,9 mm - Brushed Platinum	1.00	20
22	09 24 03 162 20 90	Nipple Ø 25 x 30 mm -	1.00	14
36	09 24 03 149 10-06	Connection Ø 41,9 x 40 mm - Brushed Platinum	1.00	-

Spare part can no longer be ordered, please order the replacement item

5	05 30 31 025 00 90	Mounting Bolt Round head 4,5 x 60 mm -	2.00	14
53	90 21 02 069 00-06	Cover/sleeve M20 x 1 - Brushed Platinum	1.00	20
23	90 14 10 032 00 90	O-Ring 18,1 x 1,6 mm -	2.00	14
9	90 31 11 030 00 90	Mounting Threaded pin with hexagon socket with cup point M5 x 5 mm -	1.00	14
51	90 23 01 141 00 90	Back-flow preventer -	1.00	14
7	09 27 89 000-06	Rosette Ø 57 x Ø 19 x 18 mm - Brushed Platinum	1.00	-

Spare part can no longer be ordered, please order the replacement item

11	09 17 11 049-06	Connection T-piece Ø 25 x 75 mm - Brushed Platinum	1.00	-
----	-----------------	--	------	---

Spare part can no longer be ordered, please order the replacement item

55	90 30 02 072 00-06	Metal shower hose 1/2" x 3/8" x 1250 mm - Brushed Stainless Steel / Platinum Matt	1.00	20
16	09 27 88 010-06	Rosette Ø 78 x Ø 30,3 x 18 mm - Brushed Platinum	1.00	20
50	09 24 77 002 90	Mounting Clamp nut Ø 40 x 6 mm -	1.00	14
31	09 14 10 112 90	O-Ring 24,0 x 2,0 mm -	1.00	14
10	09 11 10 083-06	Connection Ø 18 x 70 mm - Brushed Platinum	1.00	-

Spare part can no longer be ordered, please order the replacement item

42	09 17 11 024 20 90	Connection Distributor, shower pipe Ø 42 x 55 mm -	1.00	-
----	--------------------	--	------	---

Spare part can no longer be ordered, please order the replacement item

3	09 23 01 039 90	Sieve seal Ø 19 x 5,5 mm -	1.00	14
4	90 28 22 082 00-06	Pipe for spray set 925 x 463 x 25 mm - Brushed Platinum	1.00	-

Spare part can no longer be ordered, please order the replacement item

33	09 20 88 002-06	Pull button Ø 30 x 20 mm - Brushed Platinum	1.00	20
14	04 28 22 134 20-06	Spout Ø 25 x 800 mm - Brushed Platinum	1.00	20
1	04 12 05 091 00-06	Rainshower round Ø 300 mm - Brushed Platinum	1.00	20
28	90 15 05 064 00 90	Single-lever mixer cartridge Ø 35 mm x 58,6 mm -	1.00	-

Spare part can no longer be ordered, please order the replacement item

9015050460090 Single-lever mixer cartridge Ø 35 mm x 58,6 mm -



## Shower system with single-lever shower mixer without hand shower - Brushed Platinum SERIES SPECIFIC

26 024 661	Product version from 10/1/2023			
46	09 11 10 080 20-06	Connection Ø 40 x 68 mm - Brushed Platinum	1.00	20
39	04 28 22 038 00 90	Holder Spray holder for deck-mounted fittings -	2.00	14
24	09 31 11 024 90	Mounting Threaded pin with hexagon socket with cup point M5 x 12 mm -	1.00	14
19	09 11 10 081 20-06	Connection with shower outlet Ø 30 x 69 mm - Brushed Platinum	1.00	20
41	04 28 22 034 00-06	Pipe Ø 46 x 955 mm - Brushed Platinum	1.00	-
Spare part can no longer be ordered, please order the replacement item				