

Edition 400

31582300100 Waschtischunterbau

PRODUKT



ZEICHNUNG

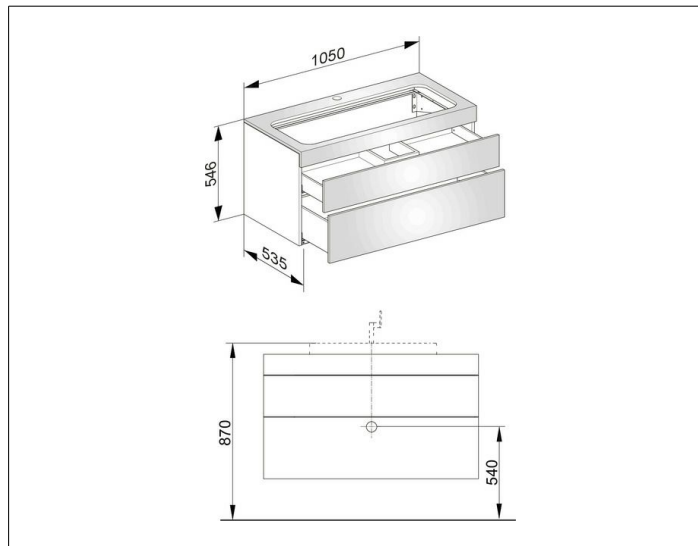

OBERFLÄCHE

weiß/Glas weiß klar

ABMESSUNG

1050 x 546 x 535 mm