

Edition 400

31582150000 Waschtischunterbau

PRODUKT



ZEICHNUNG

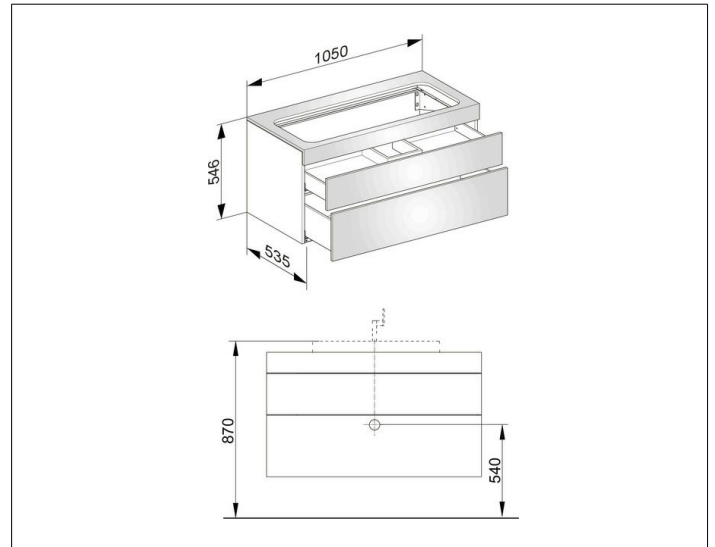

OBERFLÄCHE

anthrazit/Glas anthrazit satiniert

ABMESSUNG

1050 x 546 x 535 mm