

Productinformatieblad

Specificaties



TeSys GV4 - Vermogensschakelaar - Magnetisch - 3.5A - 3P - Kabelschoen

GV4LE03N6

EAN Code: 3606481309761

Prijs: 306,00 EUR

Hoofd

range	Tesys deca
range of product	Tesys GV4
device short name	GV4L
productnaam	TeSys GV4
product of component type	Motor vermogensschakelaar
device applicatie	Motorbeveiliging
trip unit technology	Magnetisch Elektronisch

Complementair

poles description	3P
utilisation category	A In overeenstemming met IEC 60947-2 AC-3 In overeenstemming met IEC 60947-4-1
bedieningspositie	Eender welke positie
motorvermogen kW	0,55 kW om 400...415 V AC 50/60 Hz 0,75 kW om 400...415 V AC 50/60 Hz 0,75 kW om 500 V AC 50/60 Hz 1,1 kW om 500 V AC 50/60 Hz 1,1 kW om 660...690 V AC 50/60 Hz 1,5 kW om 660...690 V AC 50/60 Hz 1,5 kW om 500 V AC 50/60 Hz 2,2 kW om 660...690 V AC 50/60 Hz 1,1 kW om 400...415 V AC 50/60 Hz
breaking capacity	100 kA Icu om 220...240 V AC 50/60 Hz In overeenstemming met IEC 60947-2 50 kA Icu om 380...415 V AC 50/60 Hz In overeenstemming met IEC 60947-2 50 kA Icu om 440 V AC 50/60 Hz In overeenstemming met IEC 60947-2 15 kA Icu om 525 V AC 50/60 Hz In overeenstemming met IEC 60947-2 8 kA Icu om 660...690 V AC 50/60 Hz In overeenstemming met IEC 60947-2 25 kA Icu om 500 V AC 50/60 Hz In overeenstemming met IEC 60947-2
control type	Omschakelen
In toegekende stroomsterkte	3,5 A
magnetische uitschakelstroom	21...49 A
Ue toegekende bedrijfspanning	690 V AC 50/60 Hz In overeenstemming met IEC 60947-2
Ui toegekende isolatiespanning	800 V AC 50/60 Hz In overeenstemming met IEC 60947-2
Ith conventionele thermische stroom in vrije lucht	115 A In overeenstemming met IEC 60947-4-1
Uimp nom. schokgolfspanning	8 kV In overeenstemming met IEC 60947-2
vermogensdissipatie per pool	6,1 W
mechanical durability	40000 cycles

De weergegeven prijs is de adviesprijs in euro excl. BTW. Deze kan onderhevig zijn aan korting. Neem contact op met uw lokale distributeur of detailhandel voor de daadwerkelijke prijs

elektrische duurzaamheid	5000 cycles voor AC-3 om 415 V sluiten 5000 cycles voor AC-3 om 415 V openen
maximale bedrijfsfrequentie	25 cyc/h
nominale werking	Continu In overeenstemming met IEC 60947-4-1
aansluitingssteek	27 mm zonder dwarsbalken 35 mm met verbreders
aansluitingen - aansluitklemmen	Schoenen-ringklemmen
aanspanmoment	9 N.m voor kabel 16...95 mm ² 5 N.m voor kabel 1,5...10 mm ²
mechanische stevigheid	Trillingen: +/- 1 mm 2...13,2 Hz In overeenstemming met IEC 60068-2-6 Trillingen: 0.7 gn 13,2...100 Hz In overeenstemming met IEC 60068-2-6 Schokken: 15 Gn 11 ms In overeenstemming met IEC 60068-2-27
hoogte	155 mm
breedte	81 mm
diepte	116 mm
gewicht product	1,5 kg
kleur	Grijs (RAL 7016)
suitability for isolation	Ja In overeenstemming met IEC 60947-1

Omgeving

standards	EN/IEC 60947-2 EN/IEC 60947-4-1
product certifications	IEC CCC EAC EU-RO MR
weerbestedigheid	In overeenstemming met IACS E10
IK beschermingsgraad	IK07 In overeenstemming met IEC 62262
pollution degree	3
IP beschermingsgraad	IP40 In overeenstemming met IEC 60529
ambient air temperature for storage	-50...85 °C
vuurbestedigheid	960 °C In overeenstemming met IEC 60695-2-11
bedrijfshoogte	5000 m
ambient air temperature for operation	-25...70 °C

Verpakkingseenheid

Eenheidstype van verpakking 1	PCE
Aantal eenheden in verpakking 1	1
verpakking 1 hoogte	12,5 cm
verpakking 1 breedte	9 cm
verpakking 1 lengte	22 cm
verpakking_1_gewicht	1,576 kg

contractuele waarborg

Garantie (in maanden)	18
------------------------------	----

Schneider Electric wil tegen 2050 de Net Zero-status hebben bereikt via partnerschappen in de toeleveringsketen, materialen met een lagere impact en circulariteit via onze doorlopende campagne "Use Better, Use Longer, Use Again" om de levensduur van producten en de recycleerbaarheid te verlengen.

[Uitleg van Environmental Data >](#)

[Hoe evalueren we de duurzaamheid van producten? >](#)

Milieuoetafdruk

Totale levenscyclus ecologische voetafdruk	113 kg CO2 eq.
Koolstofvoetafdruk van de fabricagefase [A1–A3]	10 kg CO2 eq.
Koolstofvoetafdruk van de distributiefase [A4]	0.4 kg CO2 eq.
Koolstofvoetafdruk van de installatiefase [A5]	0.4 kg CO2 eq.
Koolstofvoetafdruk van de gebruiksfase [B2, B3, B4, B6]	99 kg CO2 eq.
Koolstofvoetafdruk van de einde-levensfase [C1–C4]	3 kg CO2 eq.
Milieu Profiel	Milieuprofiel van het product

Use Better

Materialen en verpakking

Pakket met gerecycleerd karton	Ja
Verpakkingen zonder kunststof	Ja
SCIP-nummer	1b259a2c-3a3c-401a-acdd-f0837efd4018
RoHS-richtlijn van de EU	Conform
REACH-verordening	Referentie bevat geen SVHC boven drempelwaarde
Halogeenvrije status	Product met halogeenvrije kunststof onderdelen
PVC-vrij	Ja

Use Longer

Levensduurverlenging

Reparatie	Nee
-----------	-----

Use Again

Herverpakken en herfabriceren

Percentage mogelijke recycleerbaarheid	49
Circulair Profiel	Informatie over einde levensduur
Terugname	No
WEEE-label	 Het product moet op markten van de Europese Unie worden afgevoerd volgens specifieke afvalinzamelingsregels en mag nooit in een gewone vuilnisbak terecht komen.

Performance Curves

Tripping Curves for GV4L and GV4LE Combined with Thermal Overload Relay LRD or LR9

Average Operating Times at 20 °C Related to Multiples of the Setting Current

GV4L02 and GV4LE02 to 12 with LRD05 to LRD14, GV4L80 and GV4LE80 with LRD3363

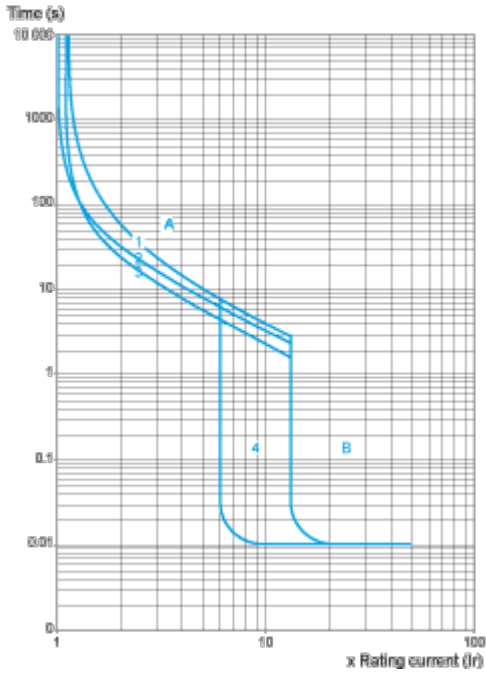

- 1 3 poles from cold state
- 2 2 poles from cold state
- 3 3 poles from hot state
- 4 6...14 Ir
- A Thermal overload relay protection zone
- B GV4L protection zone

GV4L25 and GV4LE25 with LRD 318, LRD325 GV4L50 AND GV4LE50 with LRD 332, LRD 340, LRD 350

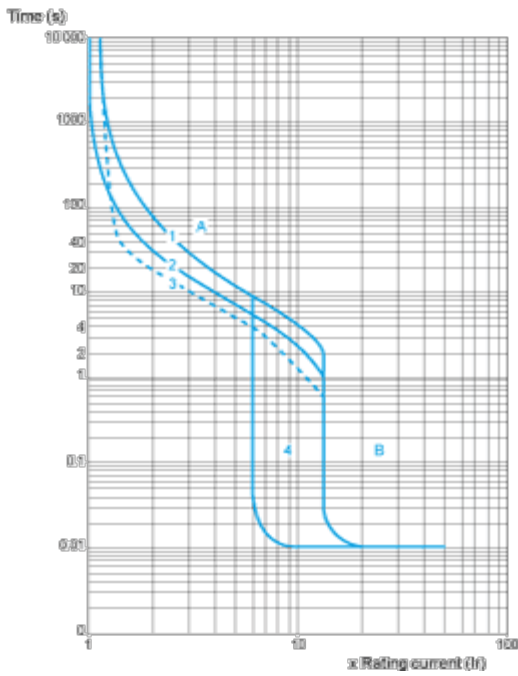

- 1 3 poles from cold state
- 2 2 poles from cold state
- 3 3 poles from hot state
- 4 6...14 Ir
- A Thermal overload relay protection zone
- B GV4L protection zone

GV4L115 and GV4LE115 with Class 10 LR9F5367, LR9D5369 and Class 20 LR9D5567, LR9F5569

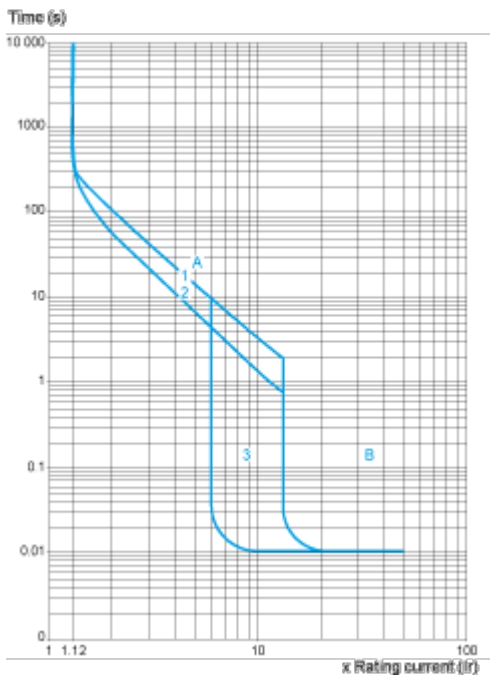

- 1 Cold state curve
- 2 Hot state curve
- 3 6...14 Ir

Current Limitation on Short-Circuit for GV4L, GV4LE (3-Phase 400/415 V)

Dynamic Stress

$I_{peak} = f(\text{prospective } I_{sc})$ at $1.05 U_e = 435 \text{ V}$

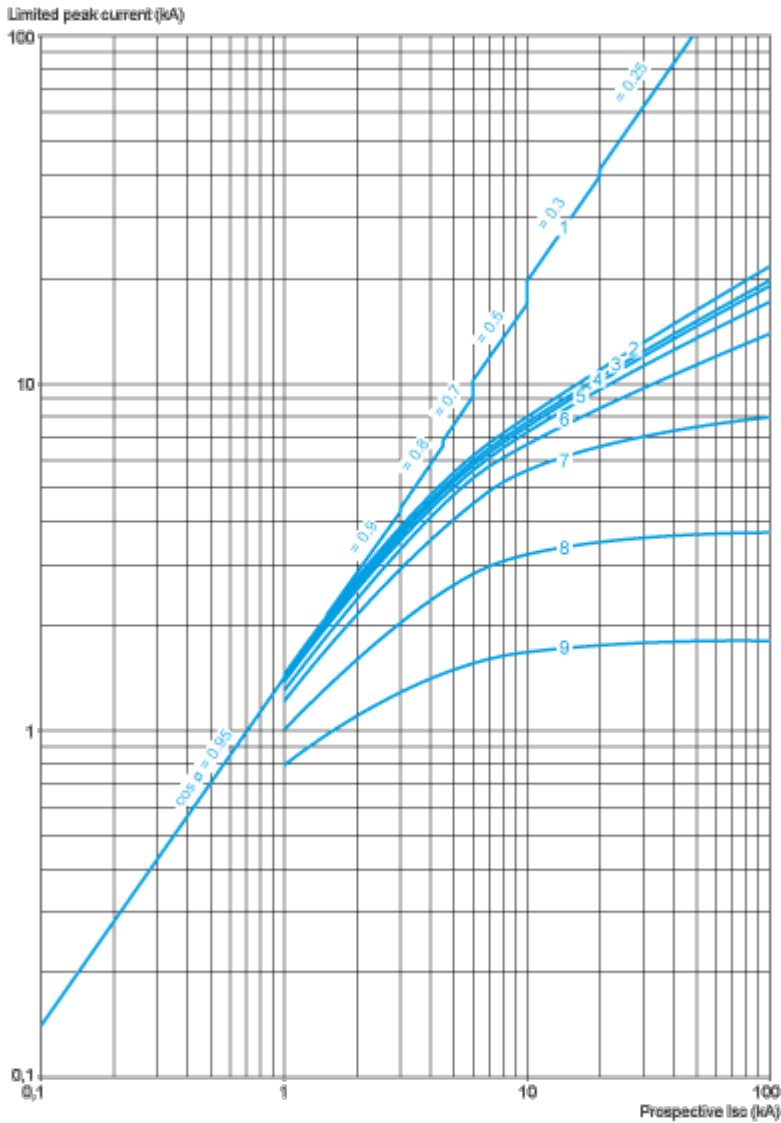

- 1 Maximum peak current
- 2 GV4L115
- 3 GV4L80
- 4 GV4L50
- 5 GV4L25
- 6 GV4L12
- 7 GV4L07
- 8 GV4L03
- 9 GV4L02

Current Limitation on Short-Circuit for GV4L, GV4LE + Thermal Overload Relay LRD or LR9 (3-Phase 400/415 V)

Dynamic Stress

$I_{peak} = f(\text{prospective } I_{sc})$ at $1.05 U_e = 435 \text{ V}$

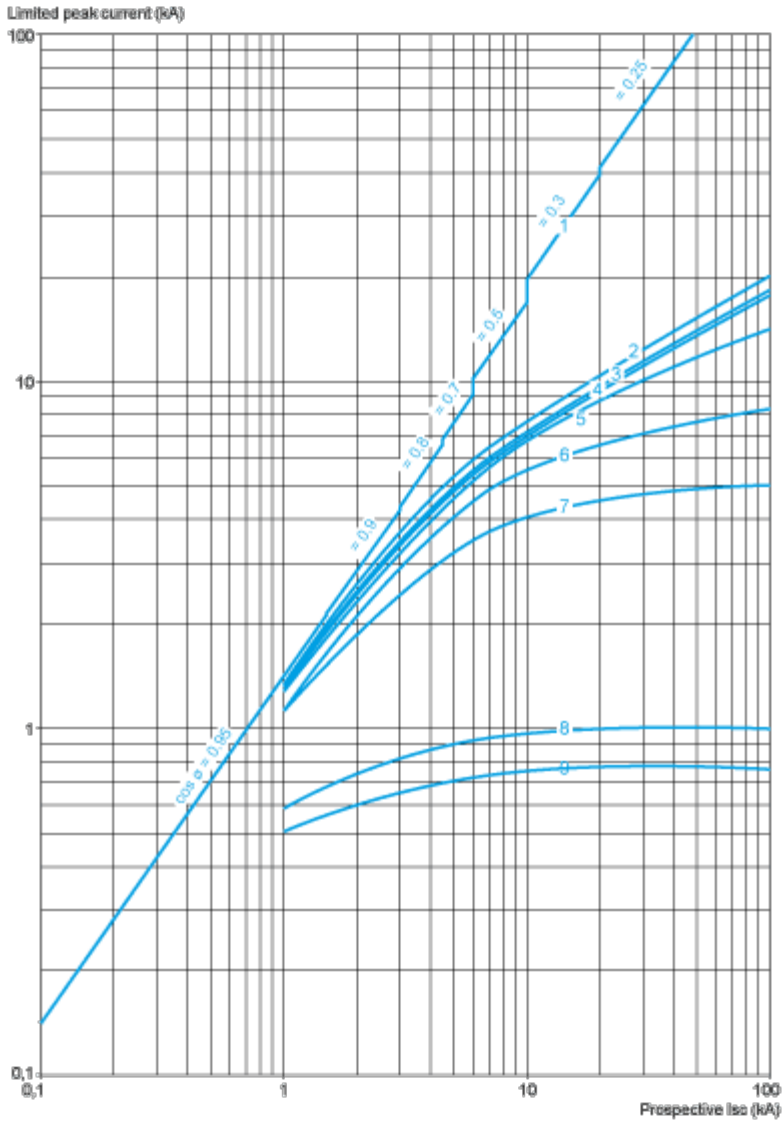

- 1 Maximum peak current
- 2 GV4L115 + LR9D5367 or LR9F5367
- 3 GV4L80 + LRD3361
- 4 GV4L50 + LRD340
- 5 GV4L25 + LRD325
- 6 GV4L12 + LRD313
- 7 GV4L07 + LRD12
- 8 GV4L03 + LRD07
- 9 GV4L02 + LRD07

Thermal Limit on Short-Circuit for GV4L, GV4LE

Thermal Limit in A²s

Sum of I²dt = f (prospective Isc) at 1.05 Ue = 435 V

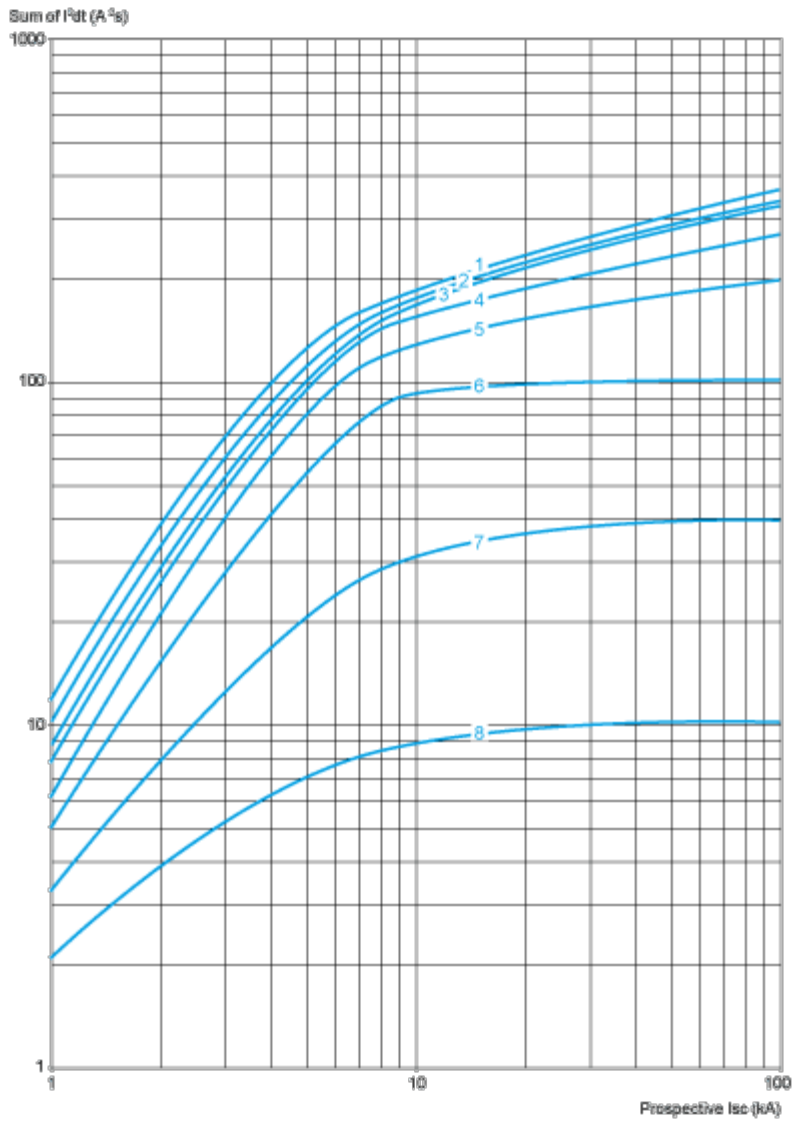

- 1 GV4L115
- 2 GV4L80
- 3 GV4L50
- 4 GV4L25
- 5 GV4L12
- 6 GV4L07
- 7 GV4L03
- 8 GV4L02

Current Limitation on Short-Circuit for GV4L, GV4LE + Thermal Overload Relay LRD or LR9

Thermal Limit in kA in the Magnetic Operating Zone

Sum of $I^2dt = f$ (prospective I_{sc}) at $1.05 U_e = 435 V$

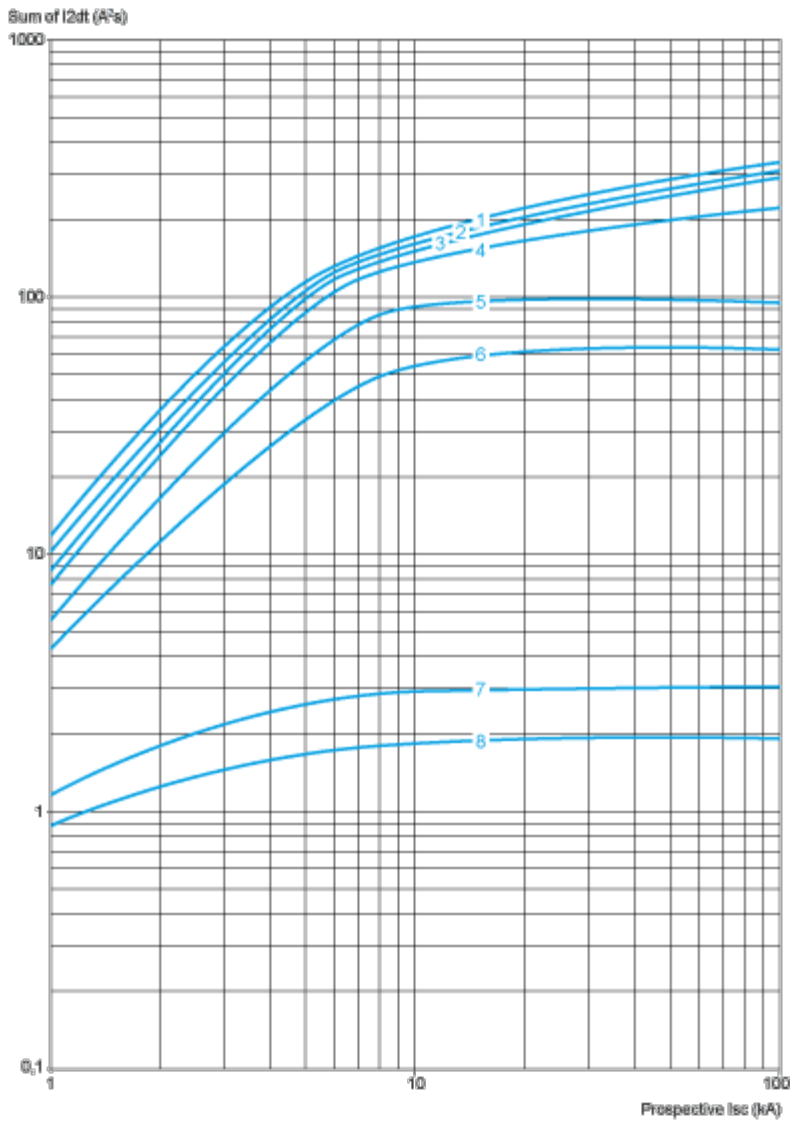

- 1 GV4L115 + LR9D5367 or LR9F5367
- 2 GV4L80 + LRD3361
- 3 GV4L50 + LRD340
- 4 GV4L25 + LRD325
- 5 GV4L12 + LRD313
- 6 GV4L07+ LRD12
- 7 GV4L03+ LRD07
- 8 GV4L02 + LRD07

Dimensions Drawings

GV4 with Toggle: GV4LE, GV4PE, GV4PEM

With EverLink® Connector

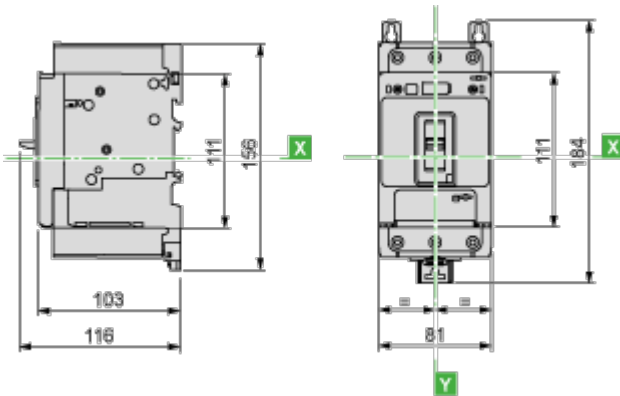

With Crimp Lug Connector

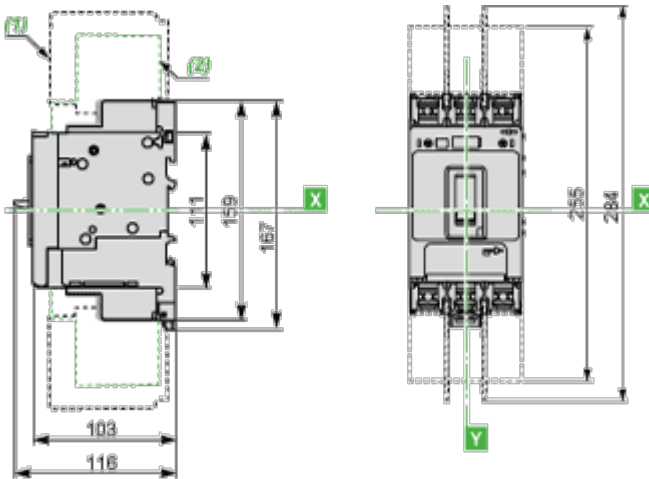

- (1) Interphases barriers
- (2) Long terminal shield

GV4 with Rotary Handle: GV4L, GV4P, or GV4LE, GV4PE, GV4PEM with GV4ADN01, GV4ADN02 Direct Mounting Rotary Handle

Dimensions

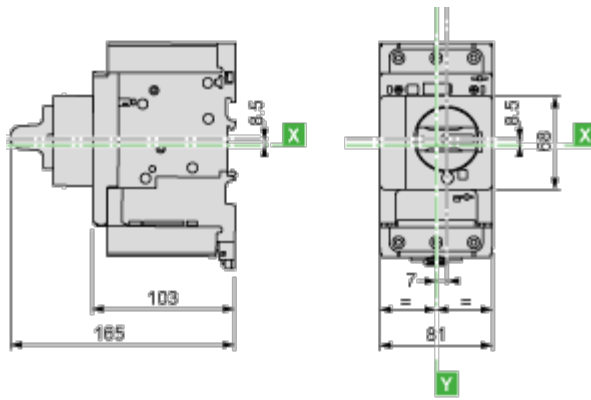

GV4L, GV4P, GV4LE, GV4PE, GV4PEM

Panel Mounting with M4 Screws

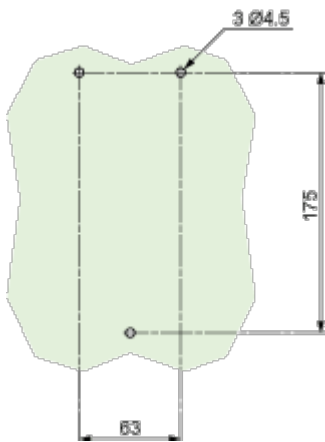

Door Cut-Out for Rotary Handle

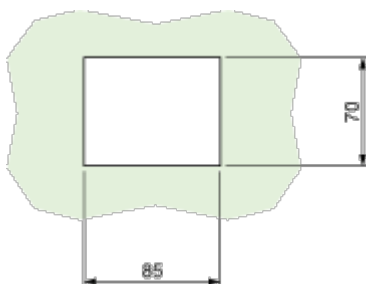

Minimum Safety Clearance

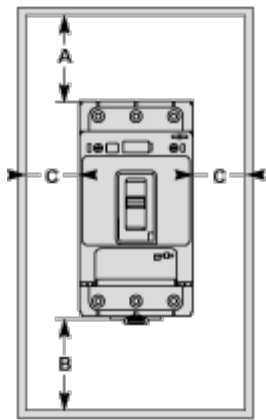

Toggle-type, rotary handle-type: identical clearance values.

	Safety Clearance (mm)					
	Painted Sheet Metal			Bare Sheet Metal		
	A	B	C	A	B	C
No accessory	30	0	0	40	0	5
Interphase barriers	0	0	0	0	0	5
Long terminal shield	0	0	0	0	0	5

Connections and Schema

Magnetic Motor Circuit Breakers
GV4L, GV4LE

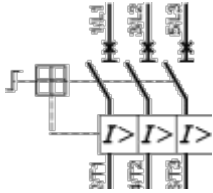

Offer Marketing Illustration

Product benefits / Features



TeSys Deca Motor Circuit Breakers

Range Accessories



Auxiliary contact



Energy sensor



Voltage release



Long terminal shield



EvertLink terminal block



Spreaders



Sealing accessories



Torque limiting breakaway bits

Offer Marketing Illustration

Product benefits / Features

TeSys Deca Motor Circuit Breakers



Increase safety

Featuring EverLink technology, double rotary contact system, and Reflex tripping mechanism to ensure your operations run smoothly and securely.



Improve efficiency

With a compact design, hassle-free installation with one-click spring terminal accessories, while easy monitoring with visible auxiliaries.



Save time

Simple to specify, install and use for all applications and easy access to facilitate maintenance on site.



Offer Marketing Illustration

Product benefits / Features

TeSys Deca Motor Circuit Breakers

Technical Benefits



- Combines a circuit breaker and overload relay in a single device.
- Gives great detection accuracy, as well as alarming and advanced protections for refs.
- Magnetic, electronic thermal-magnetic, or electronic thermal magnetic versions with advanced protection.
- Patented EverLink creep-compensating technology.
- Spring-based system ensures a long lasting connection.
- Electronic core for high-accuracy, wide settings, dual motor class 10/20.