

Productinformatieblad

Specificaties



Harmony XVB7 - Modulaire torenverlichting - lichtmodule - rood - Ø70mm - knipperlicht - gekleurde lens

XVB7C54

EAN Code: 3606487129363

Prijs: 85,00 EUR

Hoofd

range of product	Harmony XVB7
product of component type	Lichtmodule
samenstelling apparaat	Standaardlens
device short name	XVB7
bevestigingsdiameter	70 mm
type signalering	Flitsend
Lichtkleur	LED, rood
materiaal	PC (polycarbonaat)
gewicht product	0,105 kg
montagepositie	Recht/omgekeerd

Complementair

Knipperfrequentie	1 Hz
levensduur in uren	50000 h
Ue toegekende bedrijfsspanning	24 V AC/DC
nominale operationele spanningsgrenzen	21,6...26,4 V AC/DC
stroomverbruik	40 mA om 24 V AC 45 mA om 24 V DC
inschakelstroom	0,5 A
beschermingsklasse elektrische schokken	Klasse II
[Ui] rated insulation voltage	50 V
[Uimp] rated impulse withstand voltage	0,5 kV

Omgeving

pollution degree	2
omgevingstemperatuur voor werking	-25...60 °C
ambient air temperature for storage	-40...70 °C
IP-beschermingsgraad	IP66
Classificaties omgevingstype	Alleen type 4/4X/12/13 binnengebruik
trillingsweerstand	6 gn, amplitude = +/- 0,5 mm (f = 10...500 Hz)in bedrijf

De weergegeven prijs is de adviesprijs in euro excl. BTW. Deze kan onderhevig zijn aan korting. Neem contact op met uw lokale distributeur of detailhandel voor de daadwerkelijke prijs

schokbestendigheid	30 gn (duur = 6 ms) voor in bedrijf
standards	UL 60947-5-1 IEC 60947-5-1 CSA C22.2 Nr 60947-5-1
product certifications	cULus CCC RCM UKCA CE

Verpakkingseenheid

Eenheidstype van verpakking 1	PCE
Aantal eenheden in verpakking 1	1
verpakking 1 hoogte	6,500 cm
verpakking 1 breedte	7,300 cm
verpakking 1 lengte	7,500 cm
verpakking_1_gewicht	105,000 g
Eenheidstype van verpakking 2	S03
Aantal eenheden in verpakking 2	60
verpakking 2 hoogte	30 cm
verpakking 2 breedte	30 cm
verpakking 2 lengte	40 cm
verpakking 2 gewicht	6,777 kg

contractuele waarborg

Garantie (in maanden)	18
------------------------------	----

Schneider Electric wil tegen 2050 de Net Zero-status hebben bereikt via partnerschappen in de toeleveringsketen, materialen met een lagere impact en circulariteit via onze doorlopende campagne "Use Better, Use Longer, Use Again" om de levensduur van producten en de recycleerbaarheid te verlengen.

[Uitleg van Environmental Data >](#)

[Hoe evalueren we de duurzaamheid van producten? >](#)

Milieuoetafdruk

Totale levenscyclus ecologische voetafdruk	13 kg CO2 eq.
Koolstofvoetafdruk van de fabricagefase [A1–A3]	1 kg CO2 eq.
Koolstofvoetafdruk van de distributiefase [A4]	0 kg CO2 eq.
Koolstofvoetafdruk van de installatiefase [A5]	0 kg CO2 eq.
Koolstofvoetafdruk van de gebruiksfase [B2, B3, B4, B6]	11 kg CO2 eq.
Koolstofvoetafdruk van de einde-levensfase [C1–C4]	0.1 kg CO2 eq.
Milieu Profiel	Milieuprofiel van het product

Use Better

Materialen en verpakking

Pakket met gerecycleerd karton	Ja
Verpakkingen zonder kunststof	Ja
RoHS-richtlijn van de EU	Conform door vrijstelling
REACH-verordening	Referentie bevat zorgwekkende stoffen (SVHC) boven drempelwaarde

Use Longer

Levensduurverlenging

Reparatie	Nee
-----------	-----

Use Again

Herverpakken en herfabriceren

Percentage mogelijke recycleerbaarheid	87
Circulair Profiel	Informatie over einde levensduur
Terugname	Ja
WEEE-label	 Het product moet op markten van de Europese Unie worden afgevoerd volgens specifieke afvalinzamelingsregels en mag nooit in een gewone vuilnisbak terechtkomen.

Dimensions Drawings

Dimensions

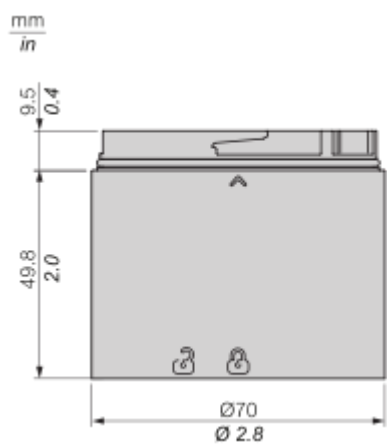

Mounting and Clearance

Mounting Overview



Drawing	Part Number	Part Description
---------	-------------	------------------

A1, A6, A11	XVB7C21B...	24V Base Direct / Tube & Cover
A1, A7, A11	XVB7C31	IO Link Base Direct / Tube & Cover
A1, A8, A11	XVB7C51	USB Base Direct / Tube & Cover
A1, A9, A11	XVB7C61	M12 Base Direct / Tube & Cover
A1, A10, A11	XVB7C21M...	AC Base Direct / Tube & Cover
A2	XVB7C9S...	2 Tones Buzzer
A2	XVB7C9T	8 Tones Buzzer
A2	XVB7C9SS	Self-Adjust Sounder 1 Tone
A3	XVB7L2...	Beacon Steady Lens
	XVB7L6...	Beacon Flashing Lens
A4	XVB7C9V	Editable Voice Alarm
A5	XVB7C2...	Steady Lens
	XVB7C5...	Blinking Lens
	XVB7C6...	Flashing Lens
	XVB7CR...	Rotating Lens
	XVB7CM9	Multi-function Clear lens
A12	XVZ00	1/2" NPT Adapter
A13	XVZ02...	Plastic Fixing Plate With Pole
A14	XVZ100	Alu Ø25mm Pole 100mm Length
A15	XVZ250	Alu Ø25mm Pole 250mm Length
A16	XVZ400	Alu Ø25mm Pole 400mm Length
A17	XVZ800	Alu Ø25mm Pole 800mm Length
A18	XVZ100T	L Bracket Alu Ø25mm Pole 100mm
A19	XVZ250T	L Bracket Alu Ø25mm Pole 250mm
A20	XVZ01...	Plastic Fixing Plate
A21	XVZ11	Metal Fixing Plate
A22	XVZ06...	Plastic Foldable Bracket
A23	XVZ09	Plastic Wall Mount Bracket

A24	XVZ07	Side Entry Adapter
A25	XVZ08	Magnetic Adapter

Technical Illustration

Dimensions



Offer Marketing Illustration

Product benefits / Features

Technical Benefits

Harmony XVB7

Conformity with IEC, CUL and CCC standards, as well as CE marking

Up to IP66 and type 4X protection ratings

High shock and vibration resistance up to 6g



Energy efficient LED with operating life up to 50,000 hours

Save up to 75% wiring time with M12 connection and push-in terminal

High brightness level with illuminance up to 3000cd/m²

Offer Marketing Illustration

Product benefits / Features

Features

Harmony XVB7



Sustainability: high brightness with low power consumption realized via energy efficient LED



Elevated design with a modern twist to enhance machine aesthetic



Modular design for adaptability, ease of maintenance and low inventory



Wide base variety with the option to be connected via USB & IO-link base



Adjustable and customizable sounder with maximum sound pressure of up to 102dB

Image of product / Alternate images

Alternative

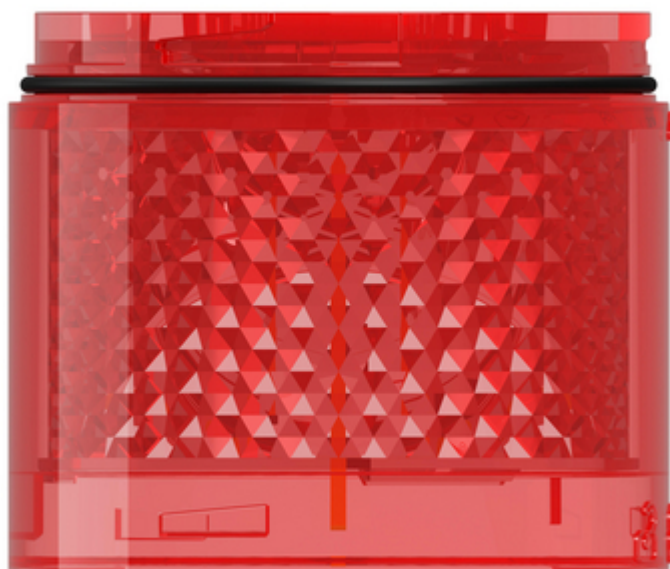
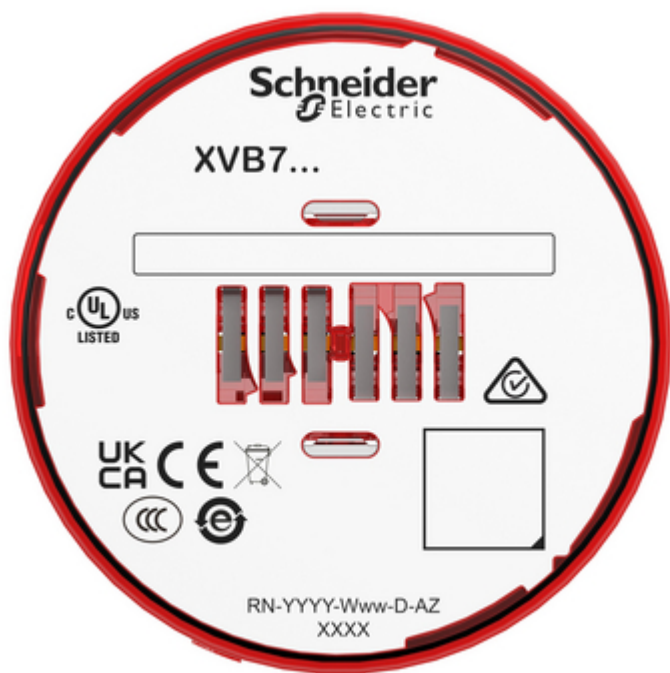

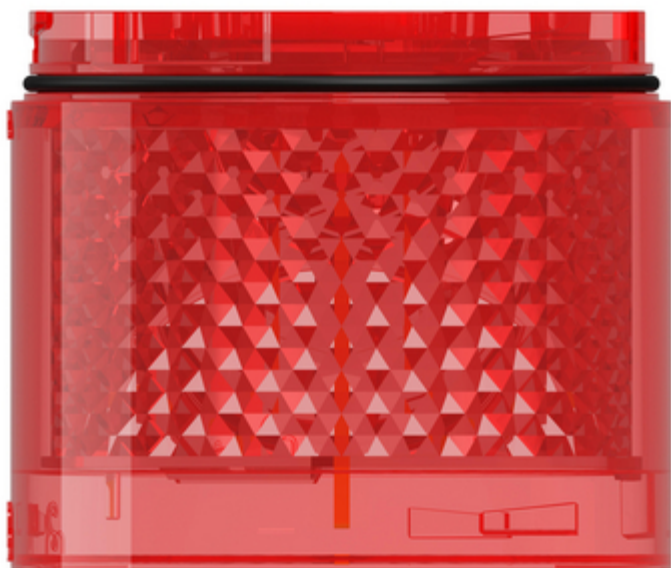
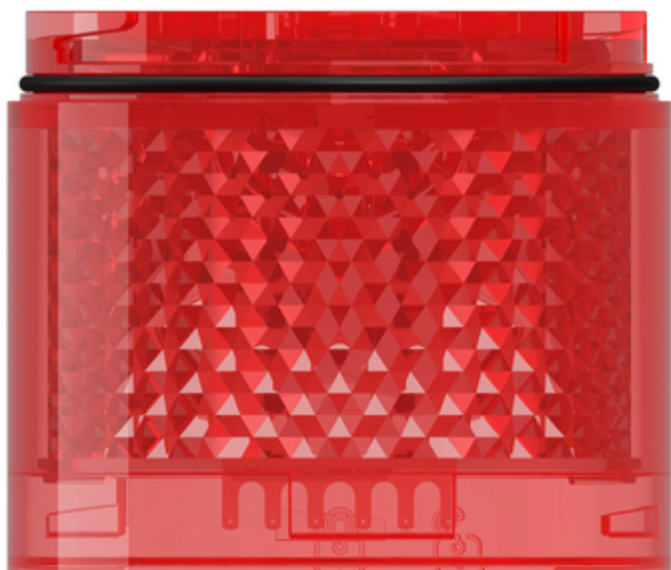

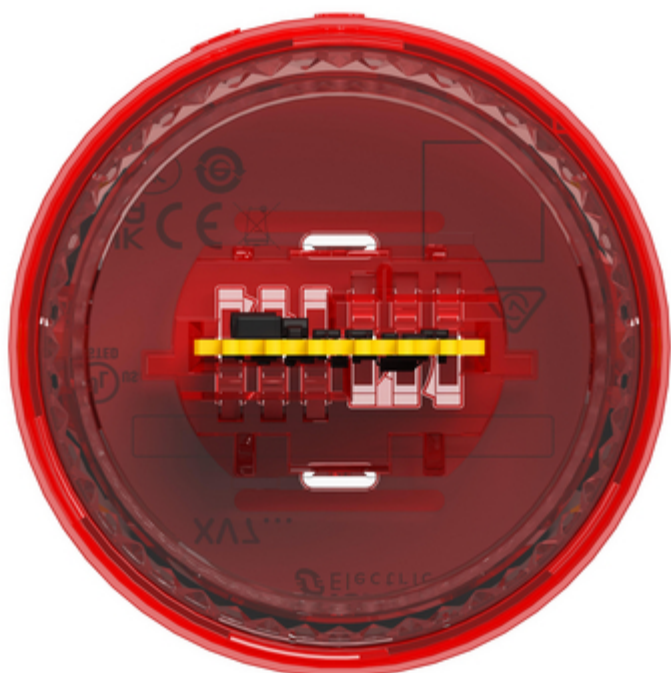
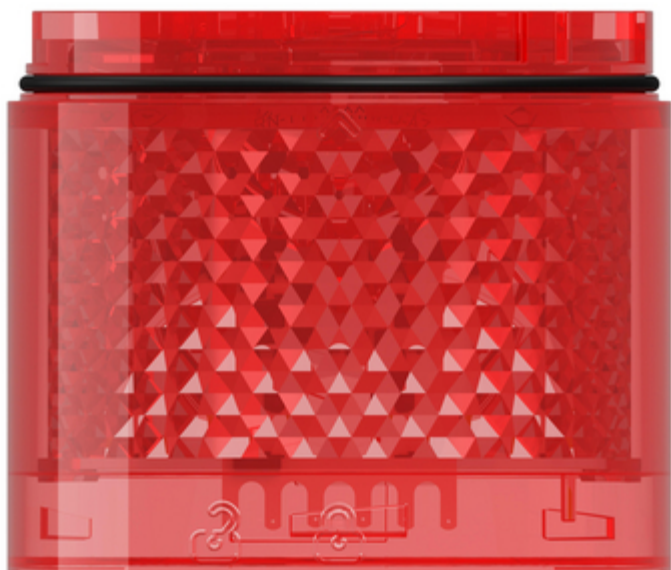

Image of product in real life situation

