

INSTALLATION AND OPERATING INSTRUCTION

## Automatic control unit OMD800

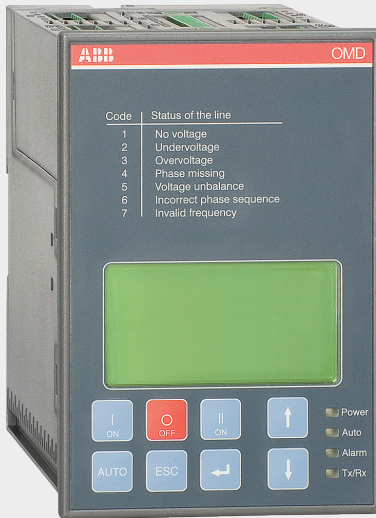

**AUTOMATIC CONTROL UNIT, OMD800**

---

# Table of contents

<b>1</b>	<b>Introduction</b>	<b>05</b>
<b>1.1</b>	<b>Use of symbols</b>	<b>05</b>
<b>1.2</b>	<b>Explanations of abbreviations and terms</b>	<b>05</b>
<b>2</b>	<b>Product overview</b>	<b>06</b>
<b>2.1</b>	<b>Typical applications</b>	<b>07–08</b>
<b>3</b>	<b>Description</b>	<b>09</b>
<b>3.1</b>	<b>OMD800 switching sequence</b>	<b>09</b>
<b>3.1.1</b>	<b>Line 1 priority</b>	<b>09</b>
<b>3.1.2</b>	<b>No line priority</b>	<b>10</b>
<b>3.1.3</b>	<b>Line 2 priority</b>	<b>11</b>
<b>3.1.4</b>	<b>Manual back switching mode</b>	<b>12</b>
<b>4</b>	<b>Installation</b>	<b>13</b>
<b>4.1</b>	<b>Dimensional drawings</b>	<b>13</b>
<b>4.2</b>	<b>Mounting</b>	<b>14</b>
<b>4.2.1</b>	<b>Door mounting</b>	<b>14–15</b>
<b>4.2.2</b>	<b>DIN-rail mounting</b>	<b>16–17</b>
<b>5</b>	<b>Connecting</b>	<b>18</b>
<b>5.1</b>	<b>Power circuit</b>	<b>18</b>
<b>5.2</b>	<b>Control circuit</b>	<b>19</b>
<b>5.2.1</b>	<b>Control circuit diagram OMD800 with motorized OTM40...125_CMA_</b>	<b>19</b>
<b>5.2.2</b>	<b>Control circuit diagram OMD800 with motorized OTM160...2500_CM_</b>	<b>20–21</b>
<b>5.2.3</b>	<b>OMD800 outputs</b>	<b>22</b>
<b>5.2.4</b>	<b>OMD800 inputs</b>	<b>22</b>
<b>6</b>	<b>Operating</b>	<b>23</b>
<b>6.1</b>	<b>Automatic control unit OMD800 in Manual Mode</b>	<b>23–25</b>
<b>6.2</b>	<b>Automatic control unit OMD800 in Automatic Mode</b>	<b>25</b>

<b>7</b>	<b>Using automatic control unit OMD800</b>	<b>26</b>
<b>7.1</b>	<b>Interface</b>	<b>26</b>
<b>7.1.1</b>	<b>Keypad</b>	<b>26</b>
<b>7.1.2</b>	<b>LEDs</b>	<b>27</b>
<b>7.2</b>	<b>Configuration</b>	<b>28</b>
<b>7.2.1</b>	<b>Menu browsing keys</b>	<b>28</b>
<b>7.2.2</b>	<b>Display</b>	<b>29–53</b>
<b>7.2.3</b>	<b>OMD800 communication via Modbus</b>	<b>53–61</b>
<b>8</b>	<b>Technical data of the automatic control unit OMD800</b>	<b>62</b>
<b>9</b>	<b>Troubleshooting OMD800</b>	<b>63–65</b>
<b>9.1</b>	<b>Explanations of internal faults OMD800</b>	<b>66</b>
<b>9.2</b>	<b>Change-over switch does not respond</b>	<b>66</b>
<b>9.3</b>	<b>Missing of both lines</b>	<b>66</b>
<b>10</b>	<b>Accessories</b>	<b>67</b>
<b>10.1</b>	<b>Fastener</b>	<b>67</b>
<b>10.2</b>	<b>Cover plate</b>	<b>68–69</b>

# 1 Introduction

This manual describes the installation and the basic operation of the OMD800 automatic control unit. The instructive part is followed by a section on available accessories.

## 1.1 Use of symbols



**Hazardous voltage:** warns about a situation where a hazardous voltage may cause physical injury to a person or damage to equipment.



**General warning:** warns about a situation where something other than electrical equipment may cause physical injury to a person or damage to equipment.



**Caution:** provides important information or warns about a situation that may have a detrimental effect on equipment.



**Information:** provides important information about the equipment.

## 1.2 Explanations of abbreviations and terms

<b>OMD</b>	The control unit of automatic transfer switching equipment, common type name for the automatic control unit
<b>OMD800</b>	The automatic control unit, high version with communication and display
<b>DPS</b>	Dual power source
<b>Modbus RTU</b>	Bus communication protocol
<b>LN1-Switch I</b>	Power supply line, eg. the primary line
<b>LN2-Switch II</b>	Power supply line, eg. the secondary line used in emergency cases
<b>Test sequence</b>	A sequence to test the functionality of the OMD and the connected change-over switch
<b>Ts</b>	Switching delay
<b>Tt</b>	Delay on transfer
<b>Ds</b>	Dead band I to II delay
<b>TBs</b>	Back switching delay
<b>DBs</b>	Dead band II to I delay
<b>Gs</b>	Generator stop delay

## 2 Product overview

The automatic transfer switch concept is applied to any application requiring switching from the primary power line to secondary power line to ensure the supply of loads.

The OMD800 has two sensors to monitor two power lines; both sensors are able to work with single phase or three-phase lines. This unit can be supplied with an external auxiliary power supply. Monitoring, configuration and control are possible via Modbus RTU connection. The OMD800 has a graphic display where the user is able to check the settings and get all the information about status of the OMD800.

**Analysing the voltage, frequency and the phase balance. Includes the generator START / STOP command. Communication via Modbus. DI/DO.**

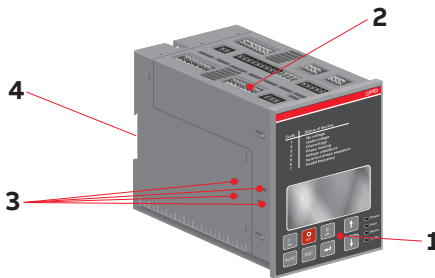

**Figure 2.1** Automatic control unit OMD800

- 1 User interface consists of display, LEDs and keypad
- 2 Connectors to connect automatic control unit with application and motorized change-over switch
- 3 Places for fasteners, used when OMD800 is mounted on the door
- 4 Place for DIN rail

## 2.1 Typical applications

### A. Mains – Generator line

In case of loss of the primary power line, the OMD800 device manages the switching to the emergency power line equipped with a genset system.

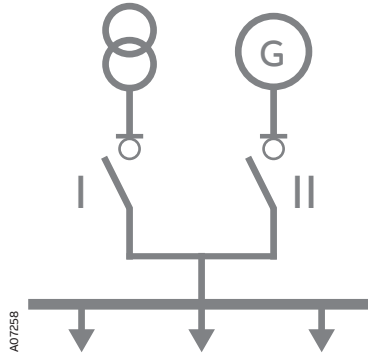

Figure 2.2 Mains - Generator line

### B. Mains a – Mains b

In case of loss of the primary power line, the OMD800 device manages the switching to a secondary power line used as an emergency source.

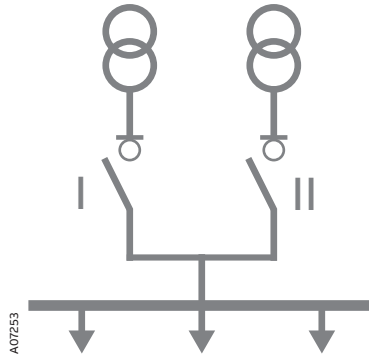
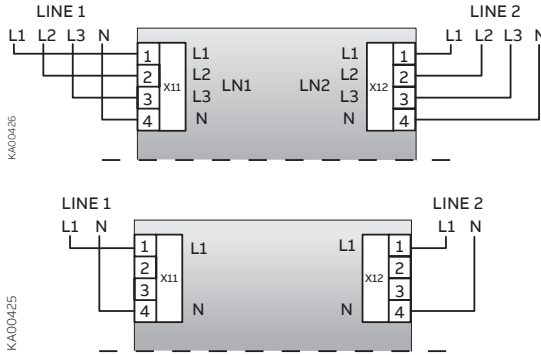

Figure 2.3 Mains a – Mains b

Automatic control unit type OMD800 is designed for single and three-phase distribution systems in diverse applications. OMD800 is supplied from Line 1 and Line 2 and can be used without external power supply.

**AUTOMATIC CONTROL UNIT, OMD800**



**Figure 2.4 OMD800 have the capability to monitor two three-phase power lines, both able to work with single phase, too.**

OMD800 has an external auxiliary power supply possibility for guarantying an uninterrupted power supply for the device in the case where the Line 1 and Line 2 are not available.

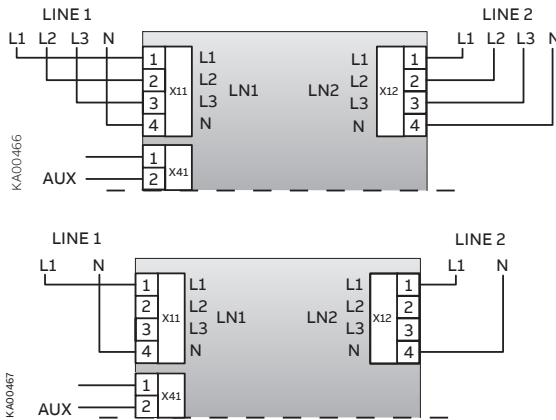

**Figure 2.5 An external 24...110 Vdc auxiliary power supply**

From the display, user can choose whether the N-line is connected or not.

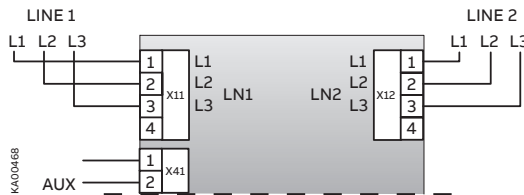

**Figure 2.6 The circuit diagram, when N-line is not connected**

## 3 Description

### 3.1 OMD800 switching sequence

#### 3.1.1 Line 1 priority

The switching sequence of OMD800 can be summarized in following steps:

- ▶ An anomaly occurs on the Line 1
- ▶ Switching delay
- ▶ Generator start
- ▶ Delay on transfer
- ▶ If Pre-transfer signal active: Pre-transfer signal output on,  
Pre-transfer I to II delay
- ▶ Change-over switch (Switch I) to the position O
- ▶ Dead band I to II delay
- ▶ Change-over switch (Switch II) to the position II
- ▶ If Pre-transfer signal active: Pre-transfer signal output off

And the back switching sequence can be summarized in the following steps:

- ▶ The Line 1 will start the normal functioning
- ▶ Back switching delay
- ▶ If Pre-transfer signal active: Pre-transfer output on,  
Pre-transfer II to I delay
- ▶ Change-over switch (Switch II) to the position O
- ▶ Dead band II to I delay
- ▶ Change-over switch (Switch I) to the position I
- ▶ If Pre-transfer signal active: Pre-transfer output off
- ▶ Generator stop delay
- ▶ Generator stop

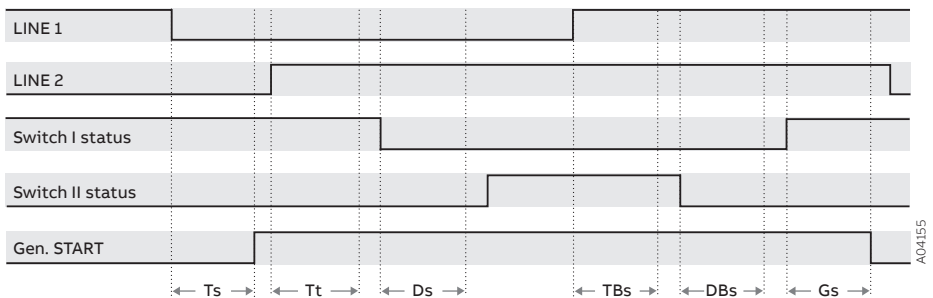

Ts: Switching delay, Tt: Delay on transfer, Ds: Dead band I to II, TBs: Back switching delay, DBs: Dead band II to I, Gs: Generator stop delay

**Figure 3.1** Automatic Switching Sequences in OMD800

**3.1.2 No line priority**

The switching sequence of OMD800 can be summarized in following steps:

- ▶ An anomaly occurs on the Line 1
- ▶ Switching delay
- ▶ Generator start
- ▶ Delay on transfer
- ▶ If Pre-transfer signal active: Pre-transfer signal output on, Pre-transfer I to II delay
- ▶ Change-over switch (Switch I) to the position O
- ▶ Dead band I to II delay
- ▶ Change-over switch (Switch II) to the position II
- ▶ If Pre-transfer signal active: Pre-transfer signal output off

And the back switching sequence can be summarized in the following steps:

- ▶ The Line 1 will start the normal functioning
- ▶ An anomaly occurs on the Line 2
- ▶ Switching delay
- ▶ If Pre-transfer signal active: Pre-transfer output on, Pre-transfer II to I delay
- ▶ Change-over switch (Switch II) to the position O
- ▶ Dead band II to I delay
- ▶ Change-over switch (Switch I) to the position I
- ▶ If Pre-transfer signal active: Pre-transfer output off
- ▶ Generator stop delay
- ▶ Generator stop

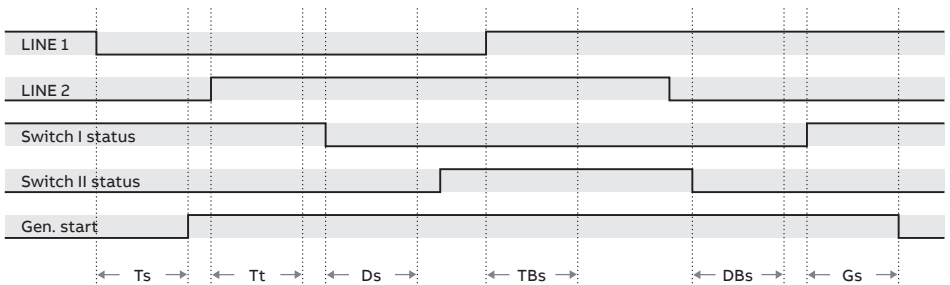

Ts: Switching delay, Tt: Delay on transfer, Ds: Dead band I to II, TBs: Back switching delay, DBs: Dead band II to I, Gs: Generator stop delay

**Figure 3.2 Automatic Switching Sequence, no line priority**

### 3.1.3 Line 2 priority

The switching sequence of OMD800 can be summarized in following steps:

- ▶ An anomaly occurs on the Line 2
- ▶ Switching delay
- ▶ If Pre-transfer signal active:               Pre-transfer output on,  
  Pre-transfer II to I delay
- ▶ Change-over switch (Switch II) to the position O
- ▶ Dead band II to I delay
- ▶ Change-over switch (Switch I) to the position I
- ▶ If Pre-transfer signal active:               Pre-transfer output off

And the back switching sequence can be summarized in the following steps:

- ▶ The Line 2 will start the normal functioning
- ▶ Back switching delay
- ▶ If Pre-transfer signal active:               Pre-transfer signal output on,  
  Pre-transfer I to II delay
- ▶ Change-over switch (Switch I) to the position O
- ▶ Dead band I to II delay
- ▶ Change-over switch (Switch II) to the position II
- ▶ If Pre-transfer signal active: Pre-transfer signal output off

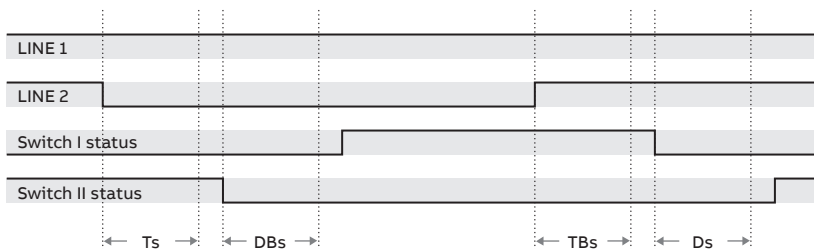

Ts: Switching delay, DBs: Dead band II to I, TBs: Back switching delay, Ds: Dead band I to II

**Figure 3.3 Automatic Switching Sequence, Line 2 priority**



Please note that generator cannot be in use, when priority is set to Line 2 (see page 34 Generator usage).



# 4 Installation

## 4.1 Dimensional drawings

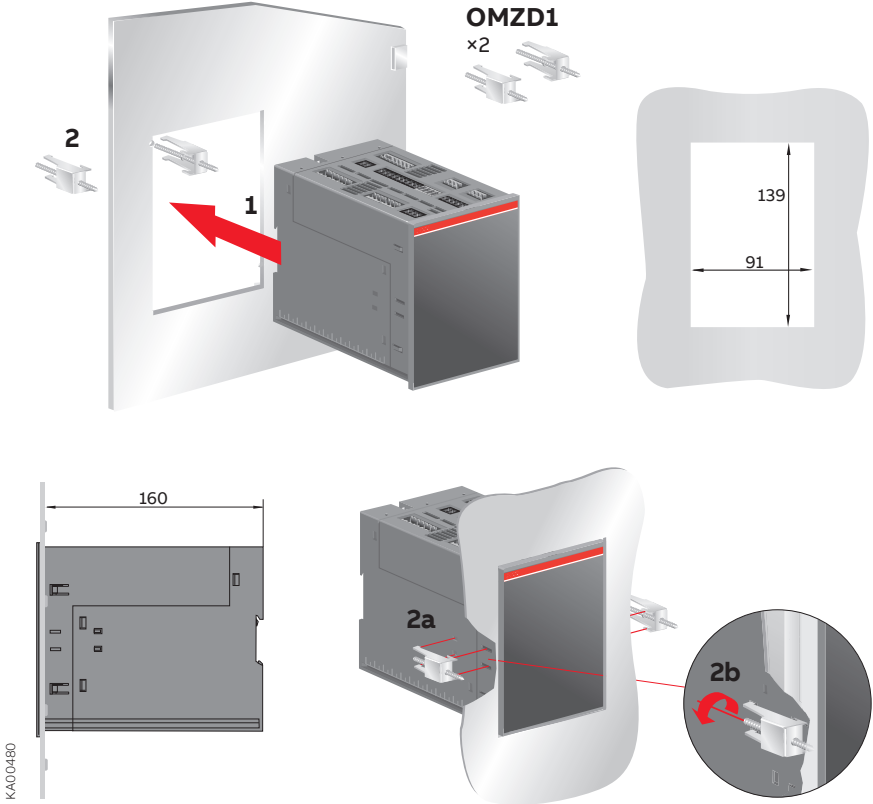
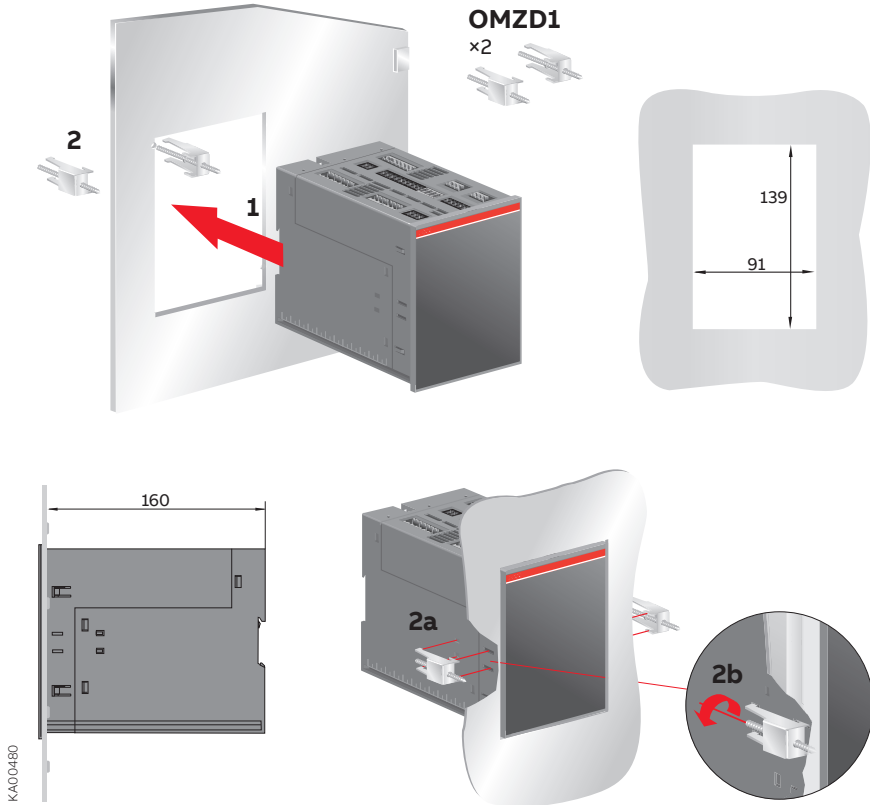

Figure 4.1 OMD800, dimensions of the device

**4.2 Mounting**

**4.2.1 Door mounting**

The automatic control unit OMD800 can be mounted on the door with the fastener OMZD1, see Accessories, Section 10. Door drilling according to Figure 4.2. As an optional extra you can use the cover plate OMZC2 on the door for OMD800, see Figure 4.3 on next page and Accessories, Section 10.



**Figure 4.2** Automatic control unit OMD800, door mounting, door drilling

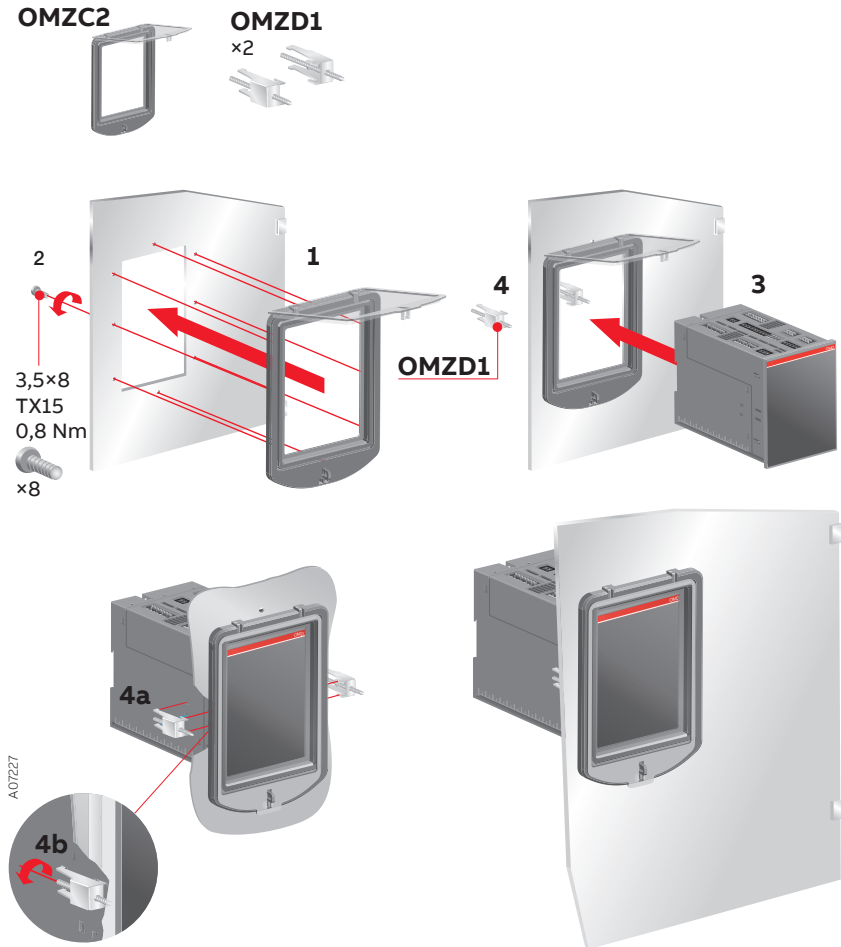

**Figure 4.3** Automatic control unit OMD800, door mounting with the cover plate, door drilling for the cover plate OMZC2, see Accessories, Section 10

**4.2.2 DIN-rail mounting**

The automatic control unit OMD800 can be mounted on the 35 mm DIN-rail, see the Figure 4.4. Door drilling, if needed, according to Figure 4.4. As an optional extra you can use the cover plate OMZC2 on the door for OMD800, see Figure 4.5 and Accessories, Section 10.

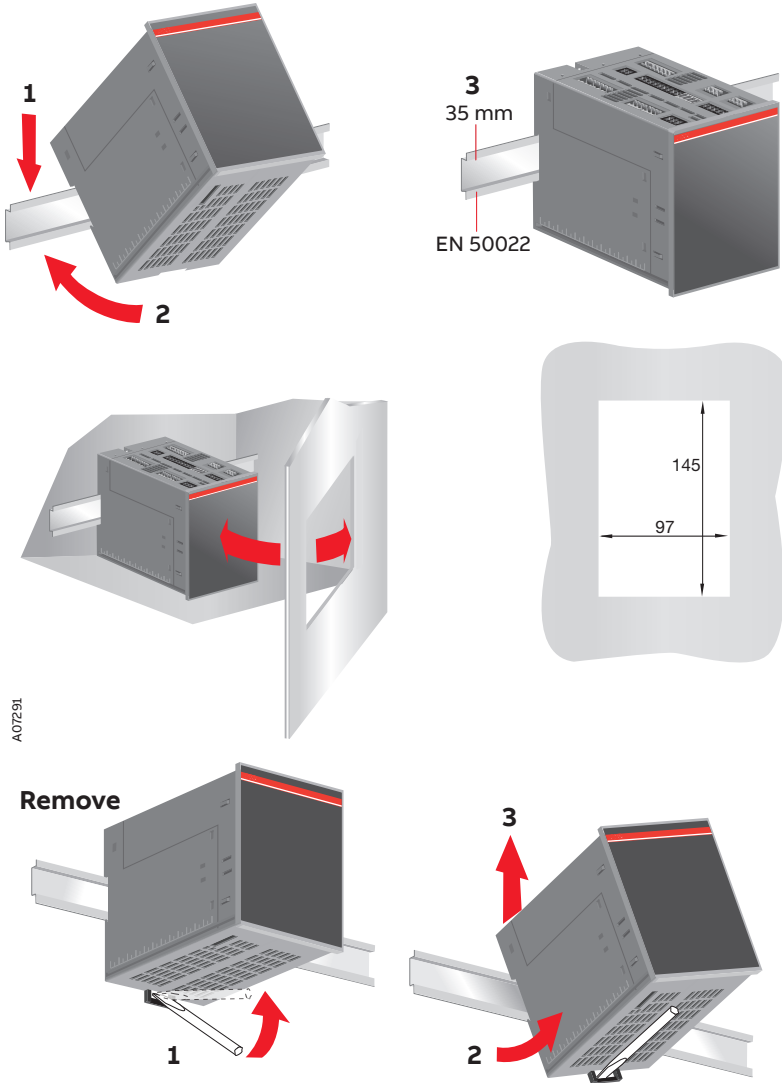

**Figure 4.4 Automatic control unit OMD800, DIN-rail mounting, door drilling**

OMZC2

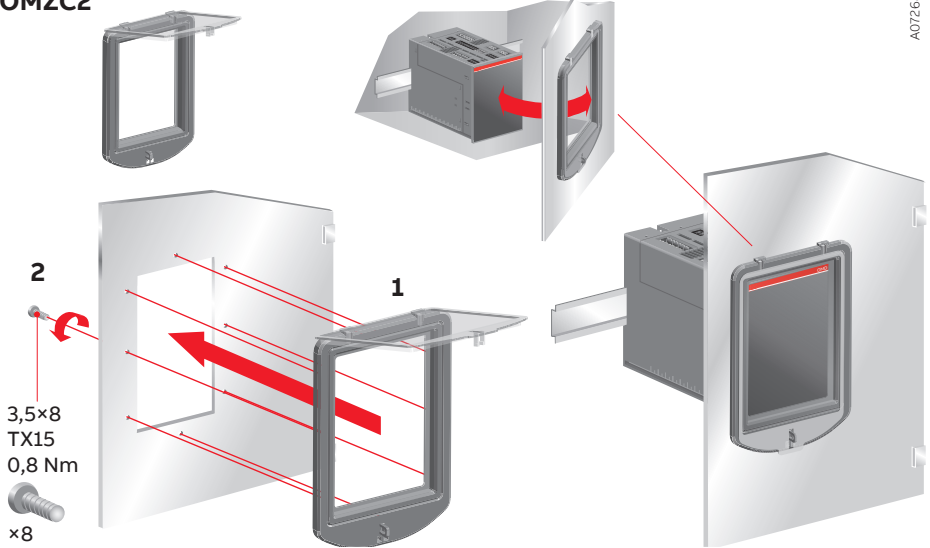

Figure 4.5 Automatic control unit OMD800, DIN-rail mounting with the cover plate, door drilling for the cover plate OMZC2, see Accessories, Section 10

---

# 5 Connecting



Only an authorised electrician may perform the electrical installation and maintenance of OTM\_ automatic transfer switches. Do not attempt any installation or maintenance actions when an OTM\_ automatic transfer switch is connected to the electrical mains.

Before starting work, make sure that the switch is de-energised.

---

## 5.1 Power circuit

### Operating and measuring voltage area on 3 phase system:

Main voltage:	100 Vac - 480 Vac ( $\pm 20\%$ )
Phase voltage:	57.7 Vac - 277 Vac ( $\pm 20\%$ )
AUX voltage:	24 Vdc - 110 Vdc (-10 to +15 %)
Frequency:	50 Hz - 60 Hz ( $\pm 10\%$ )

### Operating and measuring voltage area on 1 phase system:

Phase voltage:	57,7 Vac - 240 Vac ( $\pm 20\%$ )
AUX voltage:	24 Vdc - 110 Vdc (-10 to +15 %)
Frequency:	50 Hz - 60 Hz ( $\pm 10\%$ )

Phase setting, see the Section 7.

If 1 phase system is used and the voltage level is between 57,7 Vac - 109 Vac the auxiliary power supply (AUX) must be used.

5.2 Control circuit

5.2.1 Control circuit diagram OMD800 with motorized OTM40...125\_CMA

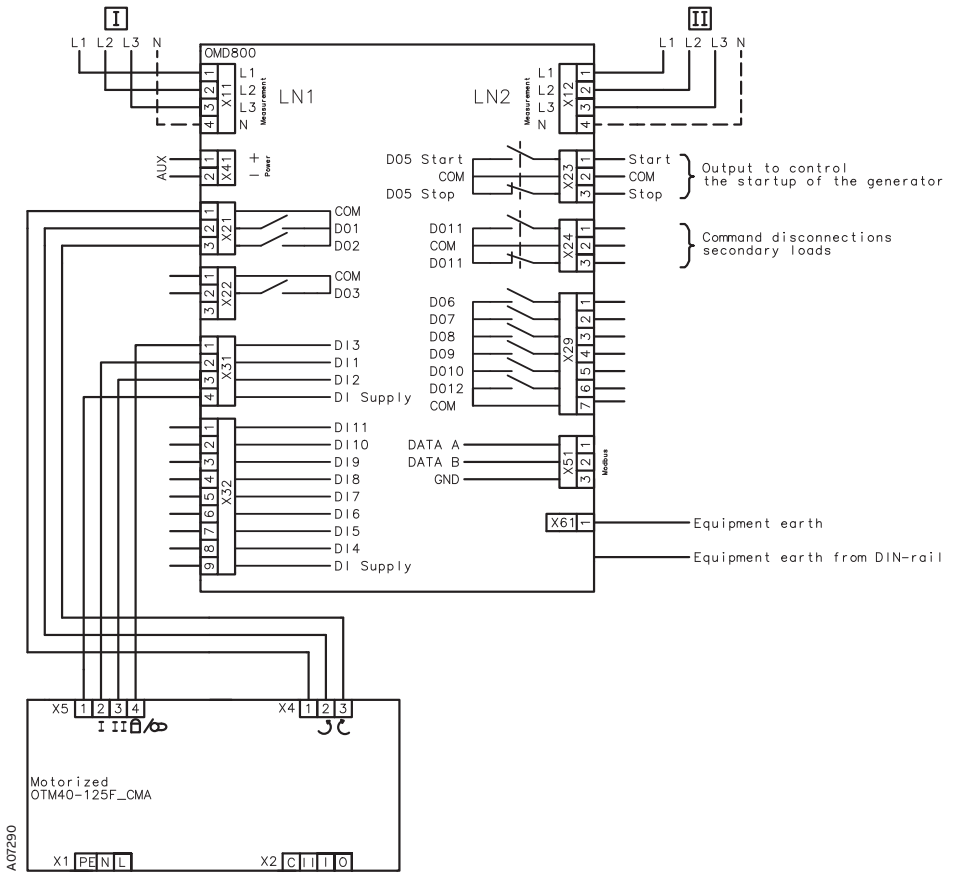

Figure 5.1 Control circuit diagram OMD800 with motorized OTM40...125\_CMA\_

5.2.2 Control circuit diagram OMD800 with motorized OTM160...2500\_CM\_

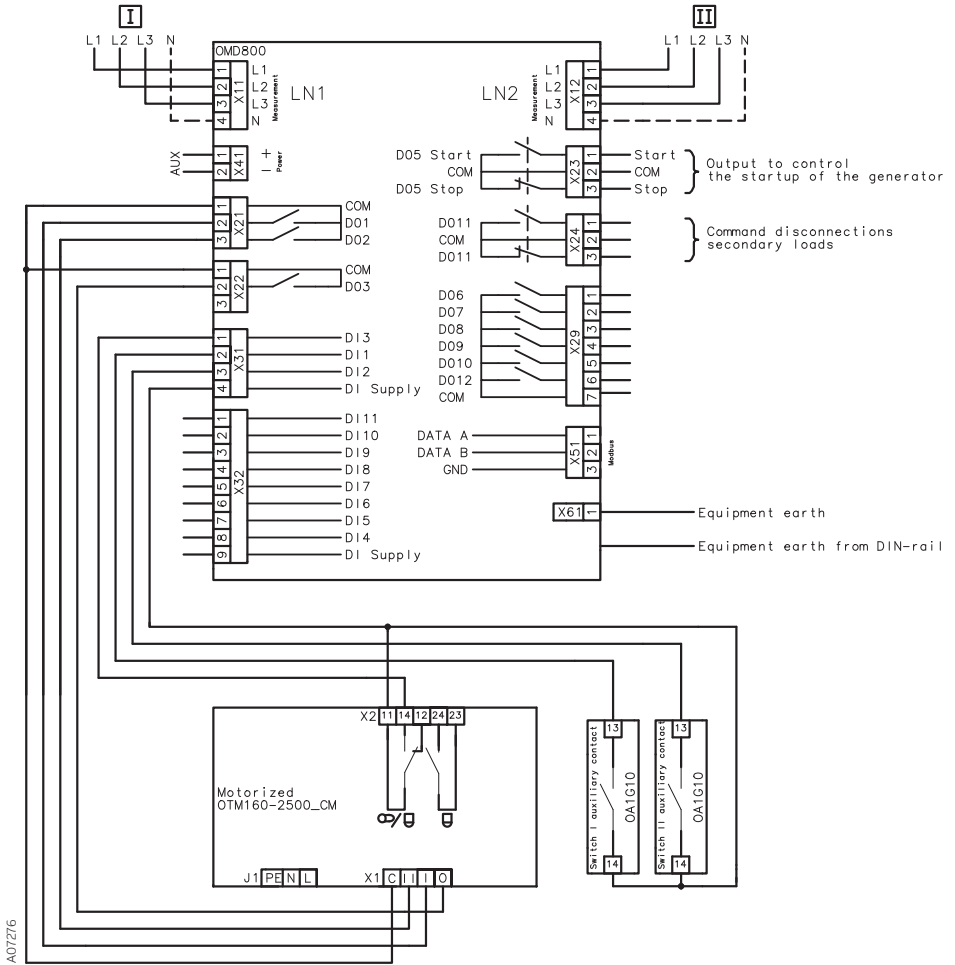
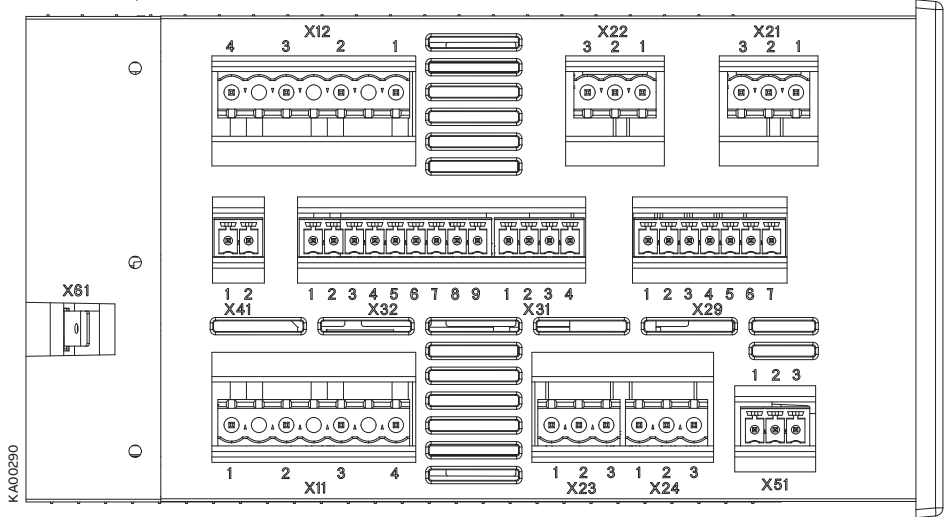

Figure 5.2 Control circuit diagram OMD800 with motorized OTM160...2500\_CM\_

**Connectors, OMD800**



**Figure 5.3 Connectors, OMD800**

Con- nec- tor	Description	Con- nec- tor	Description
X11:1	Supply I: L1	X29:1	Emergency/Alarm, NO (Programmable)
X11:2	Supply I: L2	X29:2	Line I Status, NO (Programmable)
X11:3	Supply I: L3	X29:3	Line II Status, NO (Programmable)
X11:4	Supply I: N	X29:4	Change-over Switch Alarm, NO (Programmable)
X12:1	Supply II: L1	X29:5	Manual Mode, NO (Programmable)
X12:2	Supply II: L2	X29:6	Disconnect Secondary Loads, NO
X12:3	Supply II: L3	X29:7	(Programmable) Common
X12:4	Supply II: N	X31:1	Manual / Alarm input from handle
X41:1	AUX +	X31:2	Status of switch I auxiliary contact
X41:2	AUX -	X31:3	Status of switch II auxiliary contact
X21:1	Voltage supply from motor operator OME_	X31:4	Voltage supply from the automatic control unit
X21:2	Common	X32:1	Status of Secondary Loads, NO
X21:3	Output to close switch I or open switch II NO	X32:2	(Programmable)
X22:1	Voltage supply from motor operator OME_	X32:3	External Generator Start, NO (Programmable)
X22:2	Common	X32:4	Force Commutation, NO (Programmable)
X22:3	Output for O command with switch type OTM160...2500_CM_ NO	X32:5	Generator Alarm, NO (Programmable)
	Reserved	X32:6	Remote Control to O, NO (Programmable)
X23:1	Output to control the start of the generator,	X32:7	Inhibit Switching I to II, NO (Programmable)
X23:2	NO	X32:8	Remote Control to II, NO (Programmable)
X23:3	Common	X32:9	Remote Control to I, NO (Programmable)
X24:1	Command disconnection secondary loads,		Voltage supply from the automatic control unit
X24:2	NO	X51:1	Modbus DATA B
X24:3	Common	X51:2	Modbus DATA A
	Command disconnection secondary loads,	X51:3	Modbus GND
	NC	X61	Equipment earth

**Table 5.1 Connectors OMD800**

### 5.2.3 OMD800 outputs

#### 5.2.3.1 Opening/closing command to change-over switches, X21 (DO1-DO2) and X22 (DO3)

These outputs command the change-over switch to open and close Switch I or Switch II. To guarantee the highest-level safety OMD800 monitors the correct operation of the change-over switch after a command has been sent. If the feedback of the switch status is not received within 3 seconds of the sending of the command, the device considers it as a failed command and operates as follows:

- ▶ An alarm is generated: DO6 and DO9 activate.
- ▶ Alarm LED is blinking and the alarm is written to Alarm/Event Log
- ▶ Alarm is set off by pushing the AUTO key. After that the device is always in the Manual Mode to prevent unwanted operation of the change-over switch.

Exactly the same operations are performed on the secondary line (LN2-Switch II) during the back switching sequence.

#### 5.2.3.2 Gen-Set start/stop, X23 (DO5)

Gen-Set start and stop is handled by a bistable relay. When the relay contact Start (X23:1) is closed, the generator is started. When the relay contact Stop (X23:3) is closed, the generator is stopped.

#### 5.2.3.3 Connect/disconnect command to secondary loads, X24 (DO11)

See Secondary Load parameter, Section 7.2.2.3.

#### 5.2.3.4 Programmable digital outputs, X29 (DO6-DO10 and DO12)

These outputs can be configured by the user. User can choose the function and the contact type for each of these outputs. For configuration see Section 7.2.2.3. Default configuration is shown in Section 5.2.2, Table 5.1.

### 5.2.4 OMD800 inputs

#### 5.2.4.1 Switch status input, X31:2 (DI1), X31:3 (DI2)

These two inputs are connected to change-over switch auxiliary contacts. Input X31:2 (DI1) is connected to LN1-Switch I and input X31:3 (DI2) is connected to LN2-Switch II (Switch I / II open = input inactive, Switch I / II closed = input active). Auxiliary contacts are in-built in motorized OTM40...125\_CMA\_. If OMD800 is used with motorized OTM160...2500\_CM\_, use always type OA1G10 auxiliary contacts with DI1 and DI2. See the wiring diagrams on Figure 5.1 and Figure 5.2.

#### 5.2.4.2 Force manual, X31:1 (DI3)

When the handle is attached this input is closed and OMD800 is forced to Manual Mode. To set the OMD800 back to the Automatic Mode the handle must be removed and the AUTO key pushed (Auto LED is ON).

#### 5.2.4.3 Programmable digital inputs, X32 (DI4...DI11)

These inputs can be configured by the user. User can choose function and contact type for each of these inputs. For configuration, see Section 7.2.2.4. Default configuration is shown in Section 5.2.2, Table 5.1.

## 6 Operating



Never open any covers on the product. There may be dangerous external control voltages inside the automatic control unit even if the voltage is turned off.



Never handle control cables when the voltage of the automatic control unit or external control circuits are connected.



Exercise sufficient caution when handling the unit.

### 6.1 Automatic control unit OMD800 in Manual Mode

Selecting the automatic control unit OMD800 to the Manual Mode:

- Make sure that power LED is ON, see the Figure 4.1/①.
- If Auto LED is OFF /②, the automatic control unit is in Manual Mode.
- If the Auto LED is ON, push the AUTO key once /③. The Auto LED switches to OFF and the automatic control unit OMD800 is in Manual Mode /④.

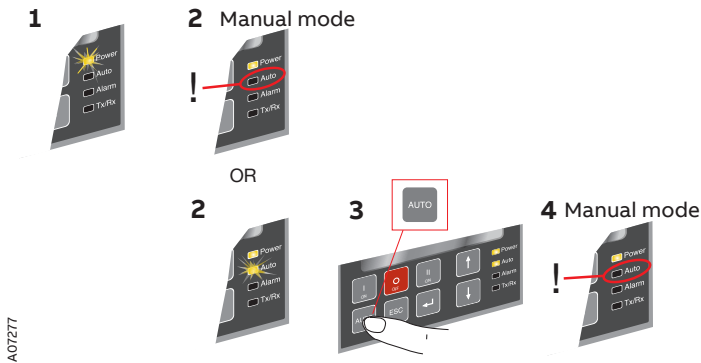
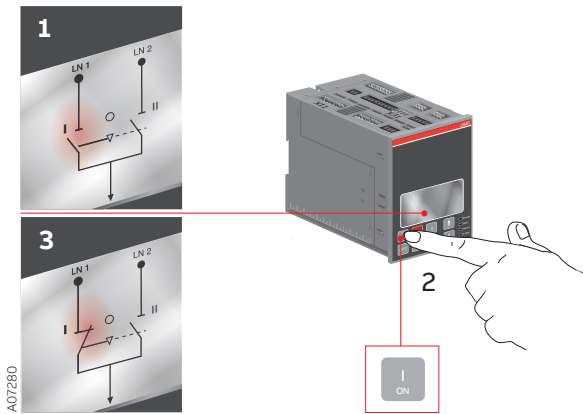

Figure 6.1 Selecting the automatic control unit OMD800 to Manual Mode

To select the operating line by the automatic control unit OMD800 in Manual Mode:

- a. Push the appropriate I, O or II key.
- b. When pushing the I-key (see the Figure 6.2/②), the I-switch will be in the ON position (the status and the line indication, see the Figure 6.2/③) and the II-switch will be in the OFF position. If the I-switch is already in the ON position, pushing the I-key does not have any influence.
- c. When pushing the O-key, the I-switch will be in the OFF position. The II-switch remains in the OFF position.
- d. When pushing the II-key, the II-switch will be in the ON position and the I-switch will be in the OFF position.
- e. If you push the I-key while the II-switch is in the ON position, first the II-switch opens (OFF position) and then the I-switch closes its contacts (ON position).



**Figure 6.2** Selecting the switch to operate, the switch status and the chosen line indication in display terminal in OMD800



If a new command is given before the switch has reached the position of the previous command, the fuse (F1) of the motor operator may operate.

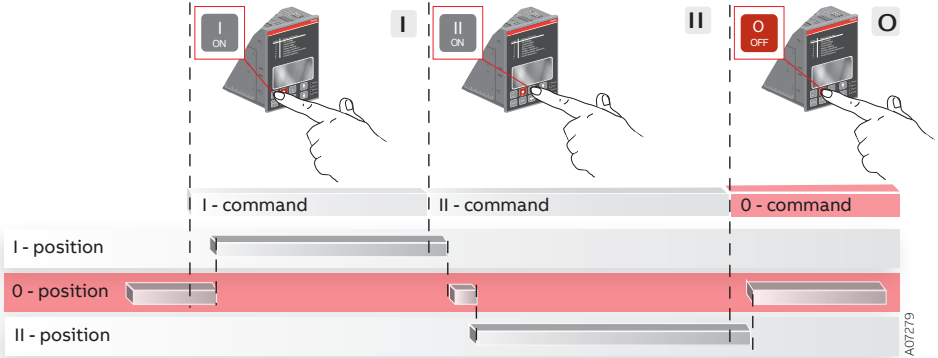

**Figure 6.3** Manual Mode control

Pushing of the O-key (= O-command) will override the commands of the other keys. For example, if you simultaneously give an O-command and another command (I or II), the motorized change-over switch OTM\_C is driven to the position O.

## 6.2 Automatic control unit OMD800 in Automatic mode

Selecting the automatic control unit OMD800 to the Automatic Mode:

- a. Make sure that power LED is ON. If Auto LED is ON/①, the automatic control unit is in Automatic Mode.
- b. If Auto LED is OFF/①, push the Auto key once/②, the Auto LED switches ON and the automatic control unit OMD800 is in Automatic Mode/③

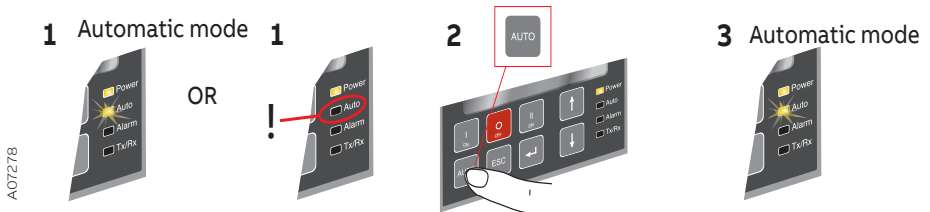

**Figure 6.4** Selecting the automatic control unit OMD800 to Automatic Mode

See the OMD800 Automatic Mode operation in Section 7.

# 7 Using automatic control unit

## 7.1 Interface



Figure 7.1 Interface of OMD800

### 7.1.1 Keypad



Figure 7.2 Keypad of OMD800

### AUTO

Selecting the automatic control unit OMD800 to the manual or automatic mode. An active alarm is set off by pushing the AUTO key.

### O key

Setting the motorized change-over switch OTM\_C to the OFF position in manual and auto mode; both switches (I and II) are in the OFF position. After pressing the O-key the automatic control unit OMD800 is always in manual mode.

### I key

Setting in manual mode the motorized change-over switch OTM\_C to position I, when the I-switch will be in the ON position and the II-switch will be in the OFF position.

### II key

Setting in manual mode the motorized change-over switch OTM\_C to position II, when the II-switch will be in the ON position and the I-switch will be in the OFF position.

### 7.1.2 LEDs

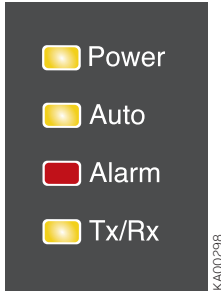

Figure 7.3 LEDs on OMD800

#### Alarm

A red Alarm LED signals an external alarm. Alarm status is explained in the Table 7.1. An active alarm is set off by pushing the AUTO key.

Alarm Status	LED Indication
Handle attached	ON
Switching logic alarm	Blinking
No alarm	OFF

Table 7.1 Alarm status indication

NOTE: When the handle is removed, the automatic control unit will stay in Manual Mode and the Alarm LED will be OFF.



When the Alarm LED is ON or blinking, check the state of the motorized change-over switch and repair the possible fault situation. An active alarm is set off by pushing the AUTO key.

#### Auto

A green Auto LED signals the automatic or the manual mode. When the automatic control unit OMD800 is in automatic mode, the Auto LED is ON. When the device is in manual mode, the Auto LED is OFF. In test sequence the Auto LED is blinking.

#### Power

A green Power LED signals the power status. When power is ON, the Power LED is ON. The automatic control unit OMD800 will remain in standby state at least one minute after power failure. A blinking Power LED indicates standby mode.

#### Tx/Rx

A green Tx/Rx LED signals the state of communication bus. When the LED is blinking, the automatic control unit OMD800 is sending data to the bus.

---

## 7.2 Configuration

### 7.2.1 Menu browsing keys

There are four menu browsing keys to operate the automatic control unit OMD800 from the display.



Enter is used to enter a new menu page and to accept function



ESC is used to exit a menu page



UP is used to move one step up on the menu



DOWN is used to move one step down on the menu



The default password is 0001.

### 7.2.2 Display

The display is a graphic display with following menu pages:

#### 7.2.2.1 Default page

From default page the user can monitor following statuses:

- Status of the change-over switch
- Status of the monitored lines
- Status of the generator
- Status of the secondary load
- Status of the Modbus Local/Remote parameter
- Name and residual value of delay times

Line 1 and Line 2 statuses are shown as a graphic picture, where graphic LEDs and a specific line status code indicate the status of the lines. When the LED is ON, there is voltage on the line and no status code is shown. In the case of an anomaly, the LED is OFF and the status code indicates what is at fault. Status codes are defined in the Table 7.2.

Code	Status of the line	Explanation
1	No voltage	Value of voltage on the line is under 10% of the Rated Voltage
2	Undervoltage	Value of voltage is under defined settings
3	Overvoltage	Value of voltage is over defined settings
4	Phase missing	There is one or more phases missing
5	Voltage unbalance	Difference between lowest and highest phase voltage is higher than defined setting
6	Incorrect phase sequence	Order of phases is incorrect
7	Invalid frequency	Value of frequency is out of defined settings

Table 7.2 Line status codes

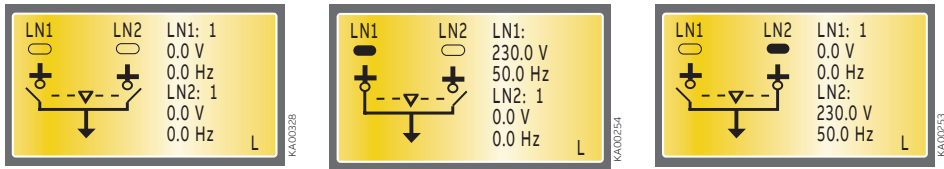

Figure 7.4 The Default pages show the status of the change-over switch and the monitored lines

When the generator is started, the letter G and the “arrow up” symbol are shown on the default page. When the generator is stopped, the letter G and the “arrow down” symbol are shown on the default page. If the letter G is blinking on the default page, there is an active generator alarm. When the generator is not used, there is no symbol on the default page. Generator Usage, see Section 7.2.2.3.

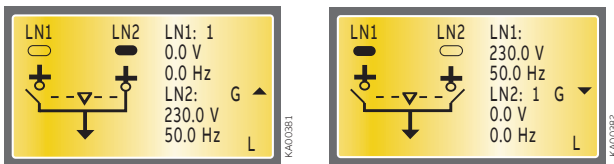
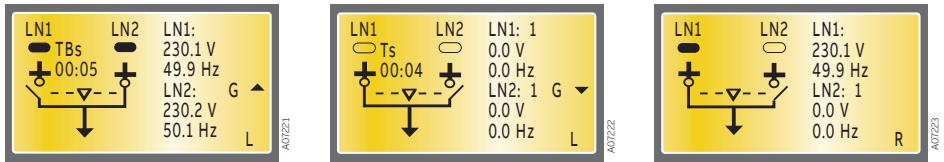

Figure 7.5 The Default pages show the status of the generator; started or stopped

During delay the name of the delay and residual time is shown in default page. When the device is used in Local –mode, the letter L is in the default page in right lower corner. If the device is used in Remote – mode, the letter R is shown in the default page in right lower corner.



**Figure 7.6** The default pages show the name and residual value of the Delay Times and the status of the Modbus Local/Remote parameter

When Secondary Load parameter is set to Opening Only or Opening and Closing the status of the device used for controlling the secondary load is shown on the default page. Please notice that the status (open/closed) of the secondary load-controlling device on the display is related to the status of the corresponding digital input. E.g. when the corresponding digital input (DI 11 as default) is activated, the display shows that secondary loads are connected. If the corresponding digital input is de-activated, the display shows that the secondary loads are disconnected.

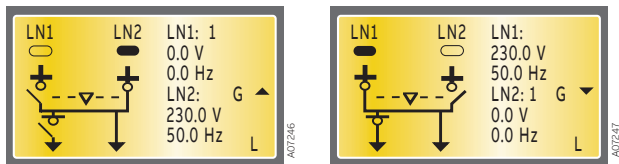

**Figure 7.7** The Default pages show the status of secondary load; open or closed

**7.2.2.2 Main Menu page**

From Default page is entered to Main Menu page by pushing the ENTER key. Main Menu page is the main page that allows entering in all the configuration subpages:

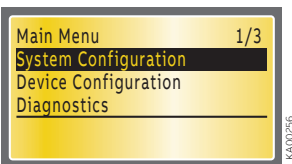

**Figure 7.8** The Main Menu page allows the entering in all the configuration subpages

### 7.2.2.3 System Configuration

In the System Configuration subpage user can configure parameters of the monitored lines; see Table 7.3. The parameter selection and its value changes are made by using UP, DOWN and ENTER keys. The System Configuration subpage requires a password. Password consists of 4 numbers, it is given by UP, DOWN and ENTER keys. The default password is 0001. Please, change the default password to your own. The password is valid one minute after leaving the password protected subpage. If the password is forgotten or lost, please, contact product support.

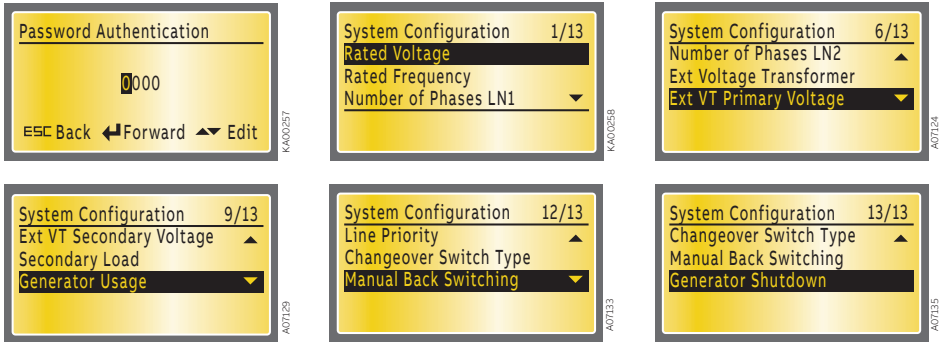

Figure 7.9 System Configuration requires a password

Parameter	Values
Rated Voltage	100/57 V - 115/66 V - 120/70 V - 208/120 V - 220/127 V - 230/132 V - 240/138 V - 277/160 V - 347/200 V - 380/220 V - 400/230 V - 415/240 V - 440/254 V - 480/277 V
Rated Frequency	50 Hz and 60 Hz
Number of Phases LN1	3 phases with N / 3 phases without N / 1 phase
Number of Phases LN2	3 phases with N / 3 phases without N / 1 phase
Ext. Voltage Transformer	Absent / Present
Ext. VT Primary Voltage	100/57 V - 115/66 V - 120/70 V - 208/120 V - 220/127 V - 230/132 V - 240/138 V - 277/160 V - 347/200 V - 380/220 V - 400/230 V - 415/240 V - 440/254 V - 480/277 V - 500/288 V - 550/317 V - 600/347 V - 660/380 V - 690/400 V - 910/525 V - 950/550 V - 1000/577 V - 1150/660 V
Ext. VT Secondary Voltage	100/57 V - 115/66 V - 120/70 V - 208/120 V - 220/127 V - 230/132 V - 240/138 V - 277/160 V - 347/200 V - 380/220 V - 400/230 V - 415/240 V - 440/254 V - 480/277 V
Secondary Load	Not Used / Opening Only / Opening And Closing / Opening Pulse / Opening/Closing Pulse
Generator Usage	No Generator / Generator In Use
Line Priority	Line 1 – Switch I / Line 2 – Switch II / No Line Priority
Changeover Switch Type	Automatic OTM_C_D / Motorized OTM_C
Manual Back Switching	Off / On
Generator Shutdown	Off / On

Table 7.3 Parameters and values of the System Configuration

## Rated Voltage

Rated Voltage is the rated voltage of the system. Value is announced as main voltage/phase voltage, Volts. Factory setting is 400/230 V.

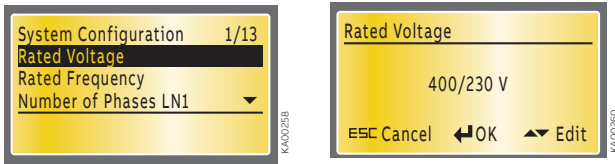

Figure 7.10 Rated Voltage, factory setting is 400/230 V

## Rated Frequency

Rated Frequency means assigned frequency of the system. Value is announced as Hertz. Factory setting is 50 Hz.

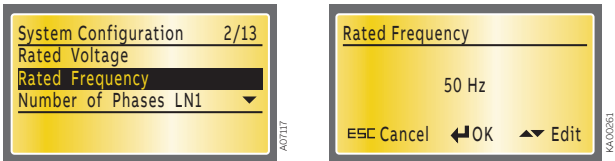

Figure 7.11 Rated Frequency, factory setting is 50 Hz

## Number of Phases LN1

In Line 1 user can choose between a one-phase and a three-phase system with or without N. Three-phase system with N is the default.

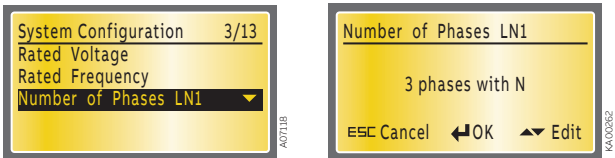

Figure 7.12 Number of phase LN1, 3 phases with N is the default

## Number of Phases LN2

In Line 2 user can choose between a one-phase and a three-phase system with or without N. Three-phase system with N is the default.

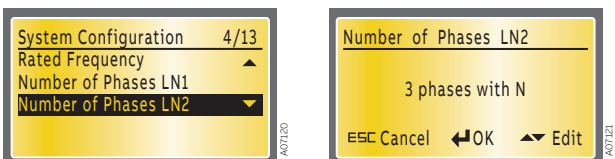

Figure 7.13 Number of phases LN2, 3 phases with N is the default

## External Voltage Transformer

User can choose whether the voltage transformers are used in measured lines or not. When the external voltage transformers are present user must set also parameters Ext VT Primary Voltage and Ext VT Secondary Voltage according to transformer ratio. Absent is the default.

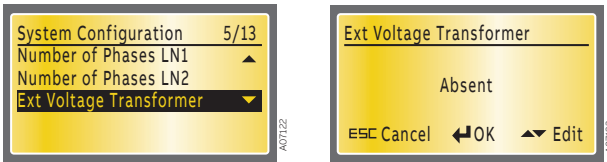

Figure 7.14 Ext Voltage Transformer, Absent is the default

## External Voltage Transformer Primary Voltage

If external voltage transformer is present user has to set primary voltage of the external voltage transformer. Primary voltage is set according to rated operational voltage of the system. Factory setting is 690/400 V.



Figure 7.15 Ext VT Primary Voltage, factory setting is 690/400V

## External Voltage Transformer Secondary Voltage

If external voltage transformer is present user has to set secondary voltage of the external voltage transformer. Secondary voltage is set according to transformer ratio. Factory setting is 400/230 V.



Figure 7.16 Ext VT Secondary Voltage, factory setting is 400/230V

## Secondary Load

User can choose whether secondary load is Not Used, Opening Only or Opening And Closing, Opening pulse or Opening/Closing Pulse. Not Used is the default. Secondary load open and close commands are controlled with output relay X24. Open command is sent during switching sequence and close command is sent during back switching sequence.

### Output relay X24 (see control circuit diagram, Section 5.2) operates in two cases:

1. Secondary Load parameter value is Opening Only or Opening Pulse and OMD800 automatic control unit performs switching sequence
2. Secondary Load parameter value is Opening and Closing or Opening/Closing Pulse and OMD800 automatic control unit performs switching sequence or back switching sequence

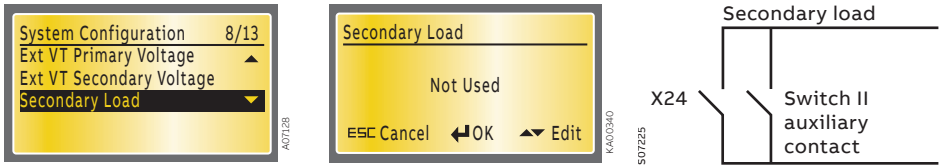

**Figure 7.17** Secondary Load, Not Used is the default



Output relay X24 de-activates in case of loss of power. If the device controlling the secondary load is powered it may close when the output relay X24 de-activates. Use Switch II auxiliary contact type OA1G10 in parallel with output relay X24 to prevent unwanted close command, see the rightmost figure above.

### Generator Usage

User can choose No Generator, when generator is not used or Generator in Use, when it is used in the Line 2 (LN 2) - Switch II. No Generator is the default.

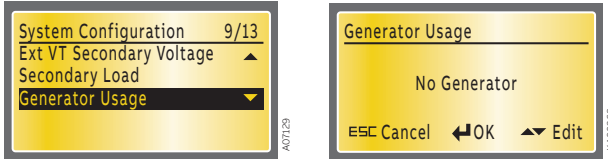

**Figure 7.18** Generator Usage, No Generator is the default



Generator should always be connected to the Line 2 (LN 2) - Switch II. When generator is in use, line priority can't be set to value Line 2 (LN 2) - Switch II.

### Line Priority

User can select the Line Priority to the Line 1 (LN 1) - Switch I, Line 2 (LN 2) - Switch II or No Line Priority. Line 1 (LN 1) - Switch I is the default.

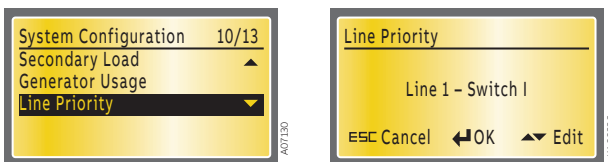

**Figure 7.19** Line Priority, Line 1 - Switch I is the default

## Changeover Switch Type

User can choose Changeover Switch Type between Automatic OTM\_C\_D and Motorized OTM\_C. Always use Automatic OTM\_C\_D when you have automatic transfer switch OTM\_C\_D or motorized OTM40...125\_CMA\_change-over switch in use. Choose Motorized OTM\_C when you have motorized OTM160...2500\_CM\_in use. Automatic OTM\_C\_D is the default.

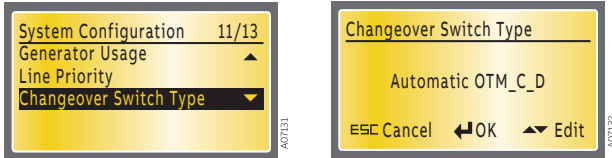

Figure 7.20 Changeover Switch Type, Automatic OTM\_C\_D is the default

## Manual Back Switching

With this parameter user can inhibit the automatic back switching sequence for example while performing maintenance on Line 1. The switch is changed to position O, if the Line 2 fails. Off is the default.

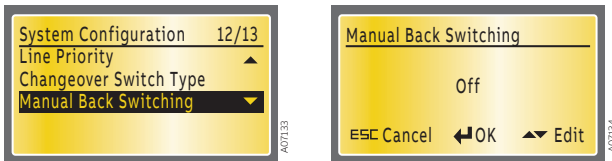

Figure 7.21 Manual Back Switching, Off is the default

## Generator Shutdown

With this parameter user can choose between two strategies how OMD800 operates after receiving a generator alarm. If the Generator Shutdown is set to On, the generator stop command will be sent immediately after receiving the generator alarm. In this case also back switching delay is overridden and the back switching to Line 1 will take place immediately. If the Line 1 is not available the switch will change to position O. If the Generator Shutdown is set to Off, loads are supplied from generator line also after receiving a generator alarm. In this case user is informed about the generator alarm by blinking the letter G on the default page Off is the default.

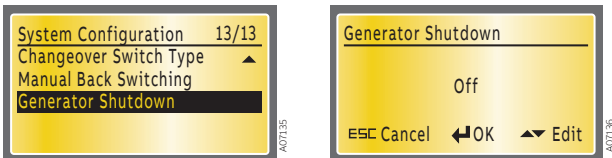

Figure 7.22 Generator Shutdown, Off is the default

### 7.2.2.4 Device Configuration

In the Device Configuration subpage user can configure programmable digital inputs and outputs, the thresholds and hysteresis for voltage and frequency, the delay times and the MODBUS communication protocol. User can also select the language and change the password in this subpage. The attribute selection and its value changes are made by using UP, DOWN and ENTER keys.

The Device Configuration subpage requires a password. Password consists of 4 numbers, it is given by UP, DOWN and ENTER keys. The default password is 0001. Please, change the default password to your own. The password is valid one minute after leaving the password-protected subpage. If the password is forgotten or lost, please, contact product support.

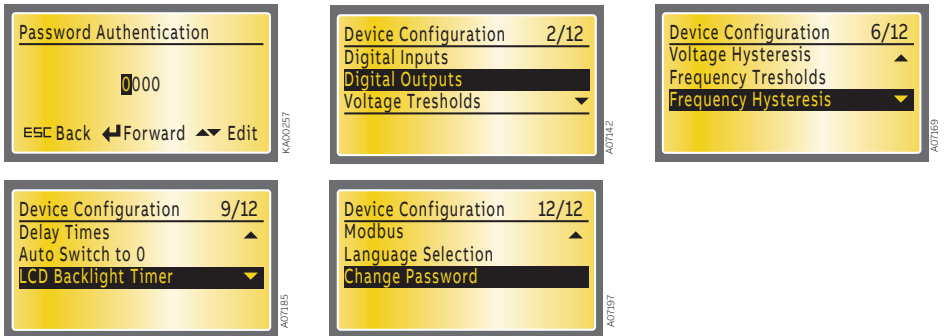

Figure 7.23 Device Configuration requires a password

Parameter	Values	
Digital Inputs	Digital Input 4	
	Digital Input 5	
	Digital Input 6	
	Digital Input 7	
	Digital Input 8	
	Digital Input 9	
	Digital Input 10	
	Digital Input 11	
	Digital Outputs	Digital Output 6
		Digital Output 7
		Digital Output 8
Digital Output 9		
Digital Output 10		
Digital Output 12		
Voltage Thresholds	Volt Threshold Min LN1, -30 %, -29 %, ..., -5 %	
	Volt Threshold Min LN2, -30 %, -29 %, ..., -5 %	
	Volt Threshold Max LN1, +5 %, +6 %, ..., +30 %	
	Volt Threshold Max LN2, +5 %, +6 %, ..., +30 %	
Voltage Hysteresis	Volt Hysteresis Min LN1, -29 %, -28 %, ..., -4 %	
	Volt Hysteresis Min LN2, -29 %, -28 %, ..., -4 %	
	Volt Hysteresis Max LN1, +4 %, +5 %, ..., +29 %	
	Volt Hysteresis Max LN2, +4 %, +5 %, ..., +29 %	
Frequency Thresholds	Freq Threshold Min LN1, -10 %, -9 %, ..., -1 %	
	Freq Threshold Min LN2, -10 %, -9 %, ..., -1 %	
	Freq Threshold Max LN1, +1 %, +2 %, ..., +10 %	
	Freq Threshold Max LN2, +1 %, +2 %, ..., +10 %	
Frequency Hysteresis	Freq Hysteresis Min LN1, -9.8 %, -9.6 %, ..., -0.8 %	
	Freq Hysteresis Min LN2, -9.8 %, -9.6 %, ..., -0.8 %	
	Freq Hysteresis Max LN1, +0.8 %, +1.0 %, ..., +9.8 %	
	Freq Hysteresis Max LN2, +0.8 %, +1.0 %, ..., +9.8 %	
Delay Times	Switching, 0...60 s	
	Delay on Transfer, 0...10 min	
	Pre-trans I to II, 0...120 s	
	Dead Band I to II, 0...60 s	
	Back Switching, 0...90 min	
	Pre-trans II to I, 0...120 s	
	Dead Band II to I, 0...60 s	
	Generator Stop, 0...30 min	
Auto Switch to O	Off	
	LN1 to O	
	LN2 to O	
	LN1 & LN2 to O	
LCD Backlight Timer	Always On / 1 sec, ..., 59 sec, 1 min, ..., 60 min	
Modbus	Modbus Address	
	Modbus Baud Rate	
	Modbus Stop Bits	
	Modbus Parity	
	Local / Remote	

Parameter	Values
Language Selection	English
	Deutsch
	Francais
	Italiano
	Espanol
	Suomi
	Russian
Change Password	Retype New Password
	INVALID PASSWORD
	PASSWORD CHANGED

**Table 7.4** Parameters and values of the Device Configuration

## Digital Inputs

User can configure Function and Contact Type (NO/NC) for Digital Inputs 4-11. Available functions are described in Table 7.5. Factory settings are described in Section .2.1.

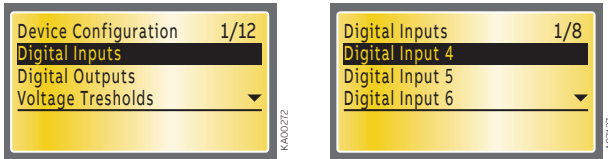
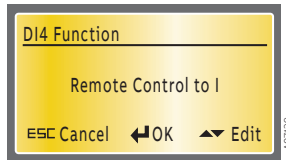
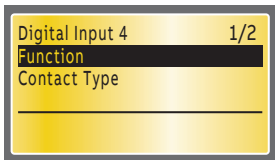

**Figure 7.24** Digital Inputs, user can configure Function (see Table 7.5) and Contact Type for Digital Inputs 4-11

### Digital Inputs 4-7, Function

Function	Description
No function	Digital input disabled
Emergency stop	Digital input to command changeover switch to position O in case of emergency, overrides all other commands
Inhibit switching I to II	Digital input to prevent switching from Line 1 to Line 2
Remote control to O	Digital input to command changeover switch to position O in AUTO mode
Remote control to I	Digital input to command changeover switch to position I in AUTO mode
Remote control to II	Digital input to command changeover switch to position II in AUTO mode
Inhibit remote control	Digital input to inhibit all remote control commands
Generator alarm	Digital input to indicate generator failure
Force commutation	Digital input to force switching from primary to secondary line in AUTO mode
External generator start	Digital input to start generator externally
Status of secondary loads	Digital input to connect feedback from secondary loads control device
Manual back switching mode	Digital input to prevent automatic switching to primary line
Remote reset	Digital input to reset active alarm
Line Priority I	Digital input to set priority to Line 1
Line Priority II	Digital input to set priority to Line 2
External Alarm	Digital input to indicate external alarm

**Table 7.5 The available Functions for Digital Inputs 4-11**



**Figure 7.25 Digital Input 4 - Function, Remote Control to I is the default**

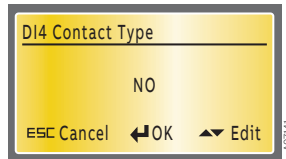
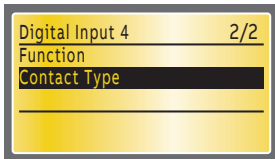

**Figure 7.26 Digital Input 4 – Contact Type, NO is the default**

## Digital Outputs

User can configure Function and Contact Type (NO/NC) for Digital Outputs 6-10 and Digital Output 12. Available functions are described in Table 7.6. Factory settings are described in Section 5.2.1.

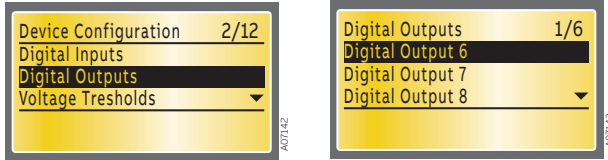

**Figure 7.27** Digital Outputs, user can configure Function and Contact Type for Digital Outputs 6-10 and Digital Output 12

## Digital Outputs 6-10 and 12, Function

Function	Description
No function	Digital output disabled
Emergency/alarm	Digital output to signal changeover switch control failure, handle attached, external fault or generator alarm.
Line I status	Digital output to signal status of the Line 1
Line II status	Digital output to signal status of the Line 2
Change-over switch alarm	Digital output to signal changeover switch control failure
Manual mode	Digital output to signal manual operating mode
Disconnect secondary loads <sup>1)</sup>	Digital output to control disconnection of the secondary loads
Pre-transfer Signal	Digital output to signal upcoming switching from I to II or from II to I
I Status	Digital output to signal switch position I
O Status	Digital output to signal switch position O
II Status	Digital output to signal switch position II

<sup>1)</sup> Digital outputs 6-10 and 12, Function Disconnect secondary loads can be only controlled via Modbus communication interface. This way user can have different loads which can be controlled independently via Modbus communication interface.

**Table 7.6** The available Functions for Digital Outputs 6-10 and 12

**Digital Outputs 6-10 and 12, Contact status**

Function	Function status	Contact type	Contact type
		NO	NC
		Contact status	
No function	Digital output disabled		
Emergency/alarm	Emergency/alarm (ON)	Closed	Open
	Emergency/alarm (OFF)	Open	Closed
Line 1 status	Line 1 status (OK)	Open	Closed
	Line 1 status (NOT OK)	Closed	Open
Line 2 status	Line 2 status (OK)	Open	Closed
	Line 2 status (NOT OK)	Closed	Open
Change-over switch alarm	Change-over switch alarm (ON)	Closed	Open
	Change-over switch alarm (OFF)	Open	Closed
Manual mode	Manual mode (ON)	Closed	Open
	Manual mode (OFF)	Open	Closed
Disconnect secondary loads <sup>1)</sup>	Disconnect secondary loads (ON)	Closed	Open
	Disconnect secondary loads (OFF)	Open	Closed
Pre-transfer signal	Pre-transfer sign (ON)	Closed	Open
	Pre-transfer signal (OFF)	Open	Closed
I Status	I Status (ON)	Closed	Open
	I Status (OFF)	Open	Closed
O Status	O Status (ON)	Closed	Open
	O Status (OFF)	Open	Closed
II Status	II Status (ON)	Closed	Open
	II Status (OFF)	Open	Closed

**Table 7.7 Digital Outputs 6-10 and 12, contact status**

<sup>1)</sup> Digital outputs 6-10 and 12, Function Disconnect secondary loads can be only controlled via Modbus communication interface. This way user can have different loads which can be controlled independently via Modbus communication interface.

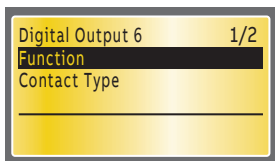

A07144

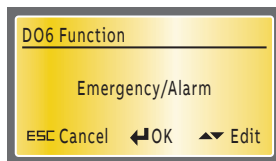

A07145

**Figure 7.28 Digital Output 6 - Function, Emergency/Alarm is the default**

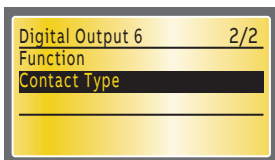

A07146

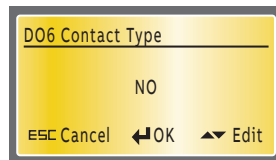

A07147

**Figure 7.29 Digital Output 6 - Contact Type, NO is the default**

### Voltage Thresholds

User can set separately Line 1 and Line 2 voltage thresholds both minimum and maximum values. Factory settings are min -20 % and max +20 %. On the Table 7.8 are shown values, which are valid when auxiliary power supply (AUX) is not used. Values of the Voltage Threshold Max LN1 and Voltage Threshold Max LN2 are also used as the voltage unbalance level.

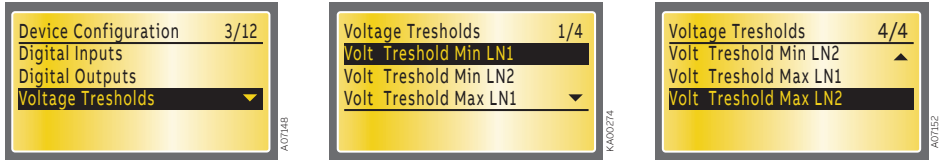

Figure 7.30 Voltage Thresholds (min and max) settings for Line 1 and Line 2

3 phases			1 phases		
Voltage / V	Voltage threshold		Voltage / V	Voltage threshold	
	Min	Max		Min	Max
100/57	-20 %	+30 %	208/120	-20 %	+30 %
115/66	-30 %	+30 %	220/127	-20 %	+30 %
120/70	-30 %	+30 %	230/132	-25 %	+30 %
208/120	-30 %	+30 %	240/138	-30 %	+30 %
220/127	-30 %	+30 %	277/160	-30 %	+30 %
230/132	-30 %	+30 %	347/200	-30 %	+30 %
240/138	-30 %	+30 %	380/220	-30 %	+30 %
277/160	-30 %	+30 %	400/230	-30 %	+30 %
347/200	-30 %	+30 %	415/240	-30 %	+30 %
380/220	-30 %	+30 %	440/254	-30 %	+30 %
400/230	-30 %	+30 %	480/277	-30 %	+20 %
415/240	-30 %	+30 %			
440/254	-30 %	+30 %			
480/277	-30 %	+20 %			

Table 7.8 Values for Voltage Thresholds suitable for different Rated Voltages in 3 phases and 1 phase system.



If the AUX is used, Min is -30 % and Max is according to this table.

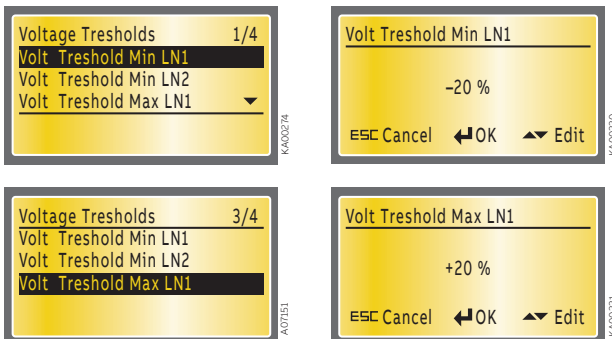

Figure 7.31 Voltage Threshold LN1, factory settings: min -20%, max 20%

### Voltage Hysteresis

User can set separately Line 1 and Line 2 voltage hysteresis both minimum and maximum values. Factory settings are min -19 % and max +19 %.



Figure 7.32 Voltage Hysteresis (min and max) settings for Line 1 and Line 2

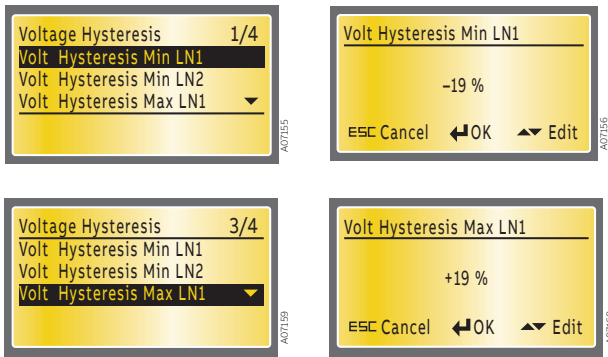

Figure 7.33 Voltage Hysteresis LN1, factory settings: min -19 %, max 19 %

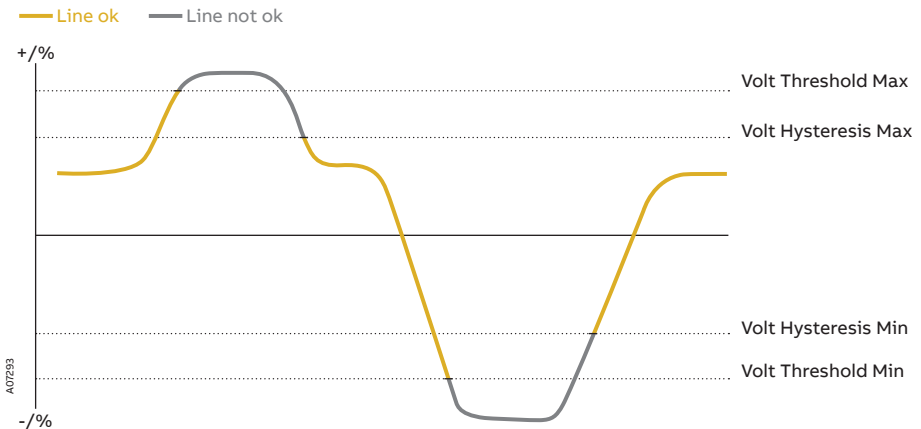

Figure 7.34 Interaction of the parameters Voltage Threshold and Voltage Hysteresis

### Frequency Thresholds

User can set separately Line 1 and Line 2 frequency thresholds both minimum and maximum values. Factory settings are min -1% and max 1%.

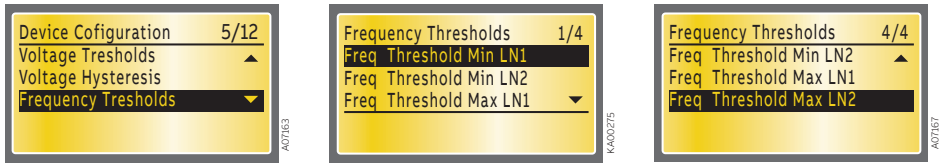

Figure 7.35 Frequency Thresholds (min and max) settings for Line 1 and Line 2



Figure 7.36 Frequency Threshold LN1, factory settings: min -1%, max 1%

### Frequency Hysteresis

User can set separately Line 1 and Line 2 frequency hysteresis both minimum and maximum values. Factory settings are min -0.8 % and max 0.8 %.



Figure 7.37 Frequency Hysteresis (min and max) settings for Line 1 and Line 2



Figure 7.38 Frequency Hysteresis LN1, factory settings: min -0.8 %, max 0.8 %

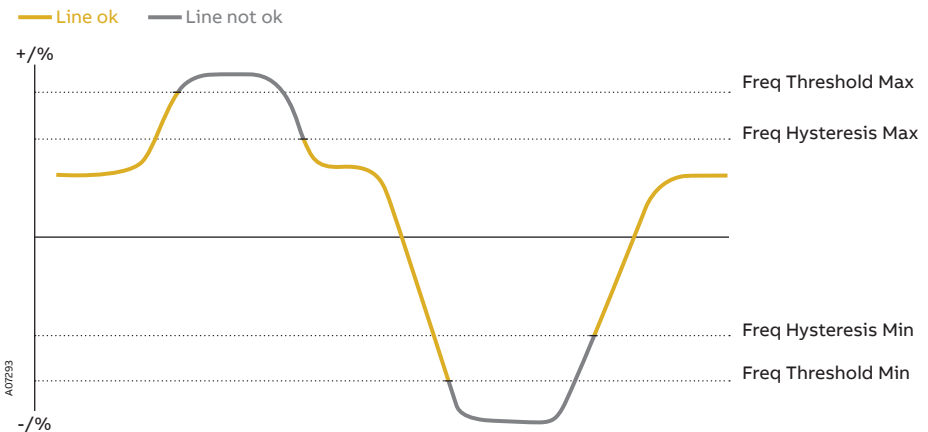

Figure 7.39 Interaction of the parameters Frequency Threshold and Frequency Hysteresis

### Delay Times

User can set delay times for Switching delay (Ts), Delay on Transfer (Tt), Pre-transfer I to II (Tp), Dead Band I to II (Ds), Back Switching delay (TBs), Pre-transfer II to I (TBp), Dead Band II to I (DBs), and Generator Stop delay (Gs). Values for delays are in the Table 7.4. Factory settings for delay times: Switching 0 s, Delay on Transfer 0 s, Pre-transfer II to I 0 s, Dead Band I to II 0 s, Back Switching 0 s, Pre-transfer I to II 0 s, Dead Band II to I 0 s, Generator Stop 5 s.



The switching sequence and the operation of corresponding Delay Times are shown in Section 3.1.

Figure 7.40 Switching 0 s, Delay on Transfer 0 s, Dead Band I to II 0 s, Back Switching 0 s, Dead Band II to I 0 s, Generator Stop 5 s

## Auto Switch to O

According to Auto Switch to O parameter the changeover switch is controlled to position O automatically in case of Line 1 or Line 2 anomalies. Available parameter values are described in Table 7.9. Off is the default.

Value	Description
Off	Automatic switching to position O disabled
LN1 to O	Automatic switching to position O in case of Line 1 anomaly.
LN2 to O	Automatic switching to position O in case of Line 2 anomaly
LN1 & LN2 to O	Automatic switching to position O in case of Line 1 or Line 2 anomaly.

**Table 7.9** Values and description of Auto Switch to O

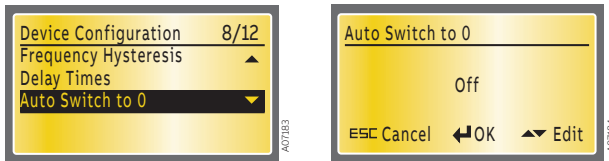

**Figure 7.41** Auto Switch to O, Off is the default



Both OMD800 and motor operator of the change-over switch need to be energized to enable the automatic switching to position O.

## LCD Backlight Timer

User can choose when to switch off the LCD backlight after the latest user interaction.

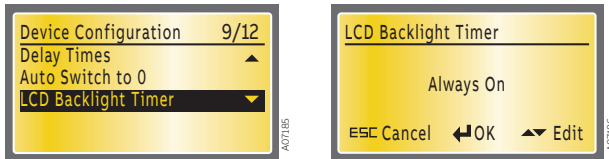

**Figure 7.42** LCD Backlight Timer, Always On is the default

## Modbus

User can set Address, Baud Rate, Stop Bits, Parity and Local/Remote for the Modbus. When Local is used device can't be neither controlled nor configured through Modbus, only monitoring is possible. When Remote is used it is also possible to control and configure the device through Modbus. Available parameter values for Modbus are described in Table 7.10. Factory settings are Modbus address 1, Modbus Baud Rate 9600, Modbus Stop Bit 1, Modbus Parity None and Modbus Local/Remote Local.

Parameter	Value
Modbus Address	1...247
Modbus Baud Rate	9600 bps
	19200 bps
	38400 bps
Modbus Stop Bits	1 Stop Bit
	2 Stop Bits
Modbus Parity	None
	Even
	Odd
Local / Remote	Local
	Remote

**Table 7.10** Parameters and values of Modbus

Tx/Rx LED indicates data transmission: LED is blinking only when data is transmitted from the OMD800.

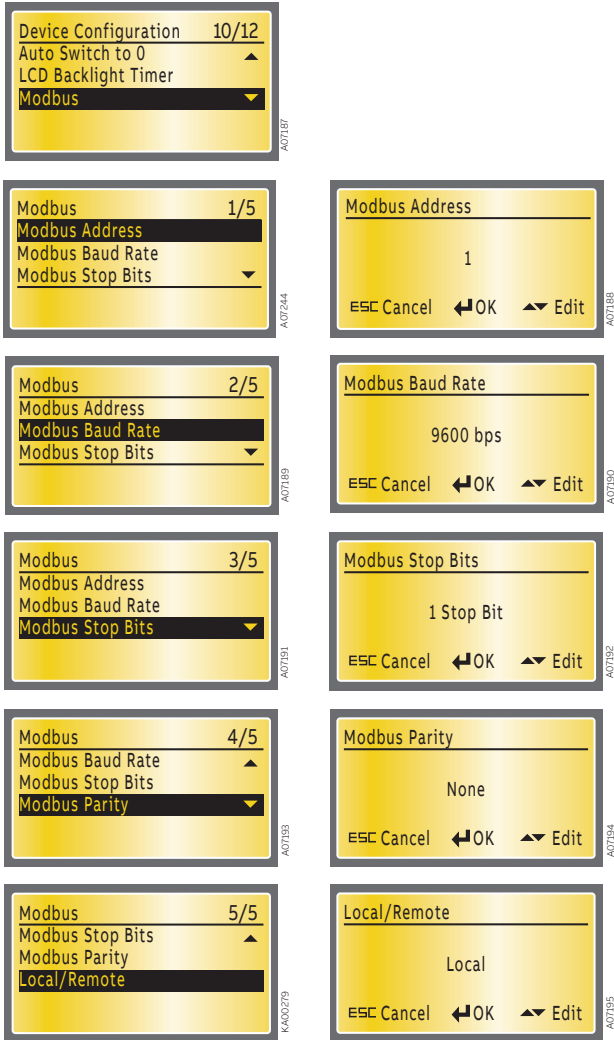

**Figure 7.43** Modbus, the factory settings are Modbus address 1, Modbus Baud Rate 9600, Modbus Stop Bit 1, Modbus Parity None and Modbus Local/Remote Local

### Language Selection

In this page it is possible to choose the Language. The choices are English, French, Italian, Spanish, Finnish, German, Russian and Chinese. Factory setting is English.

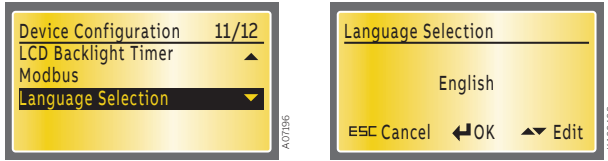

Figure 7.44 Language Selection, English as default

### Change Password

In this page it is possible to change password. The password consists of four numbers. The new password is set by using UP, DOWN and ENTER keys. 0001 is the default password.

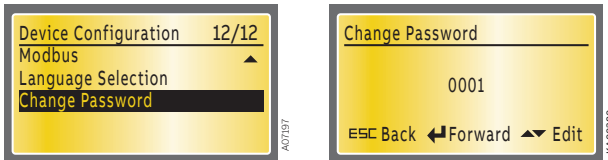

Figure 7.45 Change Password, 0001 is the default password

### Retype New Password

The new password has to be confirmed by retying it. After confirmation, the user is returned to the Device Configuration menu and on the bottom of the display the message PASSWORD CHANGED is shown. If password confirmation does not succeed, on the bottom of the display is shown the message INVALID PASSWORD and the old password is still valid. If the password is forgotten/lost, please, contact product support.

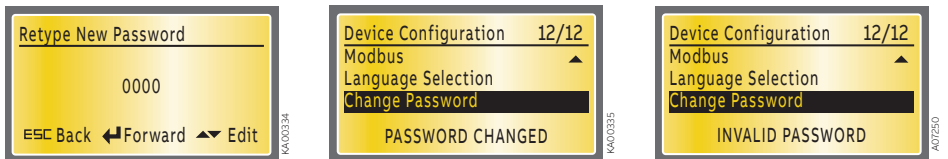

Figure 7.46 Confirmation of the new password

### 7.2.2.5 Diagnostics

Under Diagnostics are submenus: Measured Values, Alarm/Event Log, Counters, Generator Control, Test Sequence and Secondary Loads.

Attribute	Value
Measured Values	L-N Voltages
	L-L Voltages
Alarm / Event Log	View Log
	Clear Log
Counters	Operations
Generator Control	Generator Started
	Generator Stopped
Test Sequence	
Secondary Loads	Secondary Loads Connected
	Secondary Loads Disconnected

**Table 7.11 Diagnostics submenus**

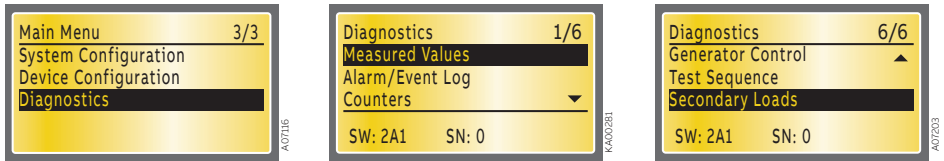

**Figure 7.47 Diagnostics**

### Measured Values

On these pages the measurement values of main and phase voltages are shown. Measurement value of frequency is also shown on the both pages.

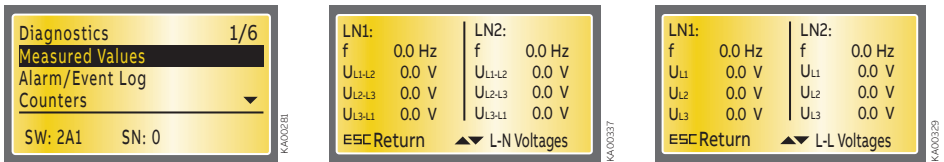

**Figure 7.48 Measured Values: Main Voltages with frequency and Phase Voltages with frequency**

### Alarm/Event log

Under Alarm/Event Log are submenus: View Log and Clear Log.

### View log

On this page the latest alarms and events are shown. The number of alarms and events is shown at the top of the page. The log can contain 50 latest alarms/events at the maximum. The latest alarm/event is always at the top of the list.

Clear log does not have its own page. The log is cleared when Clear Log is chosen and the Enter key is pressed. Alarms must be reset when clearing alarms/events.

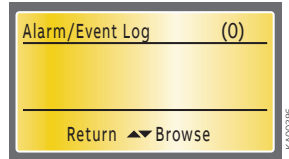
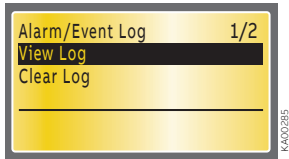
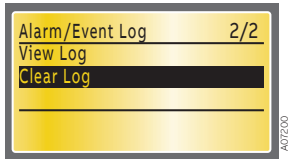
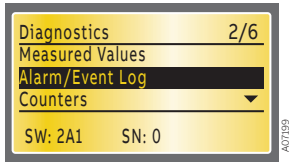

Figure 7.49 Alarm/Event Log: View Log will show 50 latest alarms and events, Clear Log will empty the log

### Counters

On this page the summary of switching operations is shown. One operation is from I to O or from II to O or from O to I or from O to II, eg. the total summary of the operations from I to II is two operations. Return back to Diagnostics menu by pushing the ESC key.

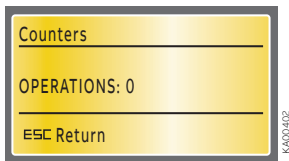
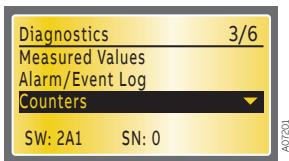

Figure 7.50 Counters page will show the summary of operations

### Generator Control

On this page the user can start or stop the generator if generator is in use (see the selection of “Generator Usage” in Section 7.2.2.3). Start and Stop commands are given with UP and DOWN arrow keys. OMD800 must be on Manual mode when starting the generator manually. Return back to Diagnostics menu by pushing the ESC key.

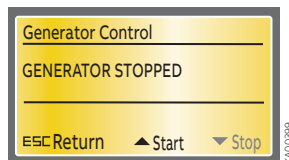
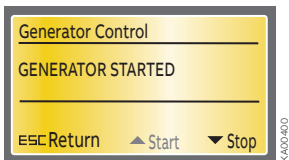
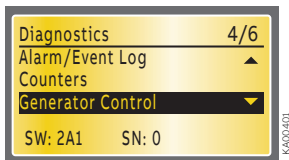
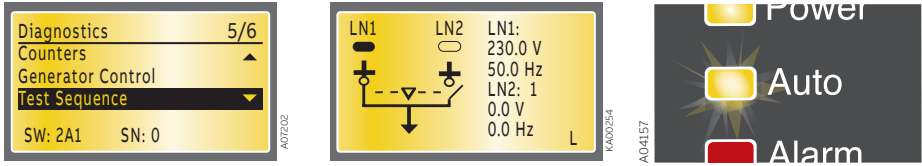

Figure 7.51 Generator Control if generator is in use

### Test Sequence

Test Sequence carries out the automatic switching sequence with delay times and generator control. The OMD800 has to be in manual mode to start the Test Sequence. When user starts the Test Sequence the device blinks LEDs (Power, Auto, Alarm) twice and returns to default page to show the status of the change-over switch, delay times and generator. If the change-over switch is in position I, normal switching sequence with generator start is executed. If in position O or II, back switching sequence is executed and generator stopped. Test Sequence can be interrupted by pressing the AUTO key. Auto LED blinks during Test Sequence.



**Figure 7.52** Test Sequence carries out the automatic switching sequence, the Auto LED blinks during Test Sequence

### Secondary Loads

On this page the user can connect or disconnect the secondary loads if the Secondary Load –parameter is set in System Configuration subpage (see the selection of “Secondary Load” on Section 7.2.2.3). Connect and Disconnect commands are given with UP and DOWN arrow keys. Return back to Diagnostics menu by pushing the ESC key.

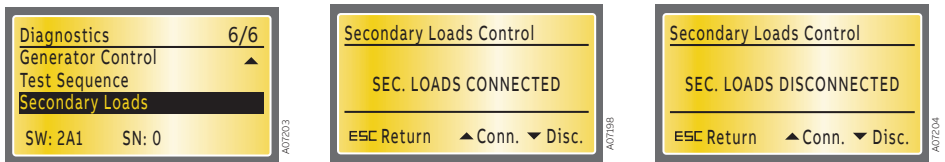

**Figure 7.53** Secondary Loads page, secondary loads can be connected and disconnected

### 7.2.3 OMD800 communication via Modbus

Monitoring, configuration and control are possible via OMD800 Modbus communication interface. Configuration and control are enabled by Local/Remote parameter (see the selection of “Local/Remote” on Section 7.2.2.4). The following Modbus functions are supported:

Function	Name
3 (0x03)	Read Holding Registers
4 (0x04)	Read Input Registers
6 (0x06)	Write Single Register
16 (0x10)	Write Multiple Registers
17 (0x11)	Report Slave ID

**Table 7.12** Supported Modbus functions

**Information of registers, values and access is available in following table:**

Register	Address	R/W	Values			
REG_CONTROL	0	W	1 = Reset			
			10 = Change-over switch to position I			
			11 = Change-over switch to position O			
			12 = Change-over switch to position II			
			13 = Test Sequence			
			21 = Open sec. loads			
			22 = Close sec. loads			
			30 = Start generator			
			31 = Stop generator			
			REG_STATUS	40	R	Bits 0-2 = LN1 line status
						0 = Voltage OK
1 = No voltage						
2 = Undervoltage						
3 = Overvoltage						
4 = Phase missing						
5 = Voltage unbalance						
6 = Incorrect phase sequence						
7 = Invalid frequency						
Bits 3-5 = LN2 status						
0 = Voltage OK						
1 = No voltage						
2 = Undervoltage						
3 = Overvoltage						
4 = Phase missing						
5 = Voltage unbalance						
6 = Incorrect phase sequence						
7 = Invalid frequency						
Bits 6-8 = Switching status						
0 = Sequence not required (line used = primary)						
1 = Sequence in progress (primary secondary)						
2 = Sequence completed (line used = secondary)						
3 = Sequence rev in progress (secondary primary)						
4 = Sequence failed						
Bit 9 = Generator controlling signal						
0 = Stopped						
1 = Started						
REG_ALARMS	54	R				0 = No Alarms
						Bit 0 = Open 1 Failure
						Bit 1 = Open 2 Failure
						Bit 2 = Disconnect SL Failure
			Bit 3 = Close 1 Failure			
			Bit 4 = Close 2 Failure			
			Bit 5 = Connect SL Failure			
			Bit 8 = Force manual (handle attached)			
			Bit 9 = External fault			
			Bit 10 = External alarm			
			Bit 12 = Generator alarm			

Register	Address	R/W	Values
REG_I_STATUS	58	R	0 = Open 1 = Closed
REG_II_STATUS	59	R	0 = Open 1 = Closed
REG_SL_STATUS	60	R	0 = Disconnected 1 = Connected
REG_GENERATOR_ALARM	61	R	0 = Inactive 1 = Active
REG_FORCE_MANUAL	62	R	0 = Inactive 1 = Active
REG_FORCE_COMMUTATION	63	R	0 = Inactive 1 = Active
REG_GENERATOR_START	64	R	0 = Inactive 1 = Active
REG_INHIBIT_SWITCHING	65	R	0 = Inactive 1 = Active
REG_INHIBIT_REMOTE	66	R	0 = Inactive 1 = Active
REG_REMOTE_O	67	R	0 = Inactive 1 = Active
REG_REMOTE_I	68	R	0 = Inactive 1 = Active
REG_REMOTE_II	69	R	0 = Inactive 1 = Active
REG_MAN_BACK_SWITCHING	70	R	0 = Inactive 1 = Active
REG_EMERGENCY_STOP	71	R	0 = Inactive 1 = Active
REG_REMOTE_RESET	72	R	0 = Inactive 1 = Active
REG_LINE_PRIORITY_I	73	R	0 = Inactive 1 = Active
REG_LINE_PRIORITY_II	74	R	0 = Inactive 1 = Active
REG_EXTERNAL_ALARM	75	R	0 = Inactive 1 = Active
REG_LN1_U1	150	R	Voltage at 0.1 V accuracy (2300 = 230.0 V)
REG_LN1_U2	152	R	Voltage at 0.1 V accuracy (2300 = 230.0 V)
REG_LN1_U3	154	R	Voltage at 0.1 V accuracy (2300 = 230.0 V)
REG_LN1_U12	158	R	Voltage at 0.1 V accuracy (2300 = 230.0 V)
REG_LN1_U23	160	R	Voltage at 0.1 V accuracy (2300 = 230.0 V)
REG_LN1_U31	162	R	Voltage at 0.1 V accuracy (2300 = 230.0 V)
REG_LN2_U1	164	R	Voltage at 0.1 V accuracy (2300 = 230.0 V)
REG_LN2_U2	166	R	Voltage at 0.1 V accuracy (2300 = 230.0 V)
REG_LN2_U3	168	R	Voltage at 0.1 V accuracy (2300 = 230.0 V)
REG_LN2_U12	172	R	Voltage at 0.1 V accuracy (2300 = 230.0 V)
REG_LN2_U23	174	R	Voltage at 0.1 V accuracy (2300 = 230.0 V)
REG_LN2_U31	176	R	Voltage at 0.1 V accuracy (2300 = 230.0 V)
REG_LN1_F	250	R	Frequency at 0.1 Hz accuracy (500 = 50.0 Hz)
REG_LN2_F	252	R	Frequency at 0.1 Hz accuracy (500 = 50.0 Hz)

Register	Address	R/W	Values
REG_SLAVE_ID	500	R	Fixed value 49
REG_SW_VERSION	501	R	Bits 8-15 = SW Version number in ASCII format Bits 0-7 = SW Version letter in ASCII format
REG_OPERATION_COUNTER	502	R	Number of switch position transitions
REG_SERIAL_NUMBER_0	560	R	Serial number digit 0
REG_SERIAL_NUMBER_1	561	R	Serial number digit 1
REG_SERIAL_NUMBER_2	562	R	Serial number digit 2
REG_SERIAL_NUMBER_3	563	R	Serial number digit 3
REG_SERIAL_NUMBER_4	564	R	Serial number digit 4
REG_SERIAL_NUMBER_5	565	R	Serial number digit 5
REG_SERIAL_NUMBER_6	566	R	Serial number digit 6
REG_SERIAL_NUMBER_7	567	R	Serial number digit 7
REG_OPERATING_MODE	600	R/W	0 = Local 1 = Remote
REG_ADDRESS	604	R/W	1...247
REG_BAUD_RATE	605	R/W	0 = 9600 1 = 19200 2 = 38400
REG_PROTOCOL	606	R/W	0 = Even parity / 8 data bits / 1 stop bit 1 = Odd parity / 8 data bits / 1 stop bit 2 = No parity / 8 data bits / 1 stop bit 3 = Even parity / 8 data bits / 2 stop bits 4 = Odd parity / 8 data bits / 2 stop bits 5 = No parity / 8 data bits / 2 stop bits
REG_TAG_NAME_0	607	R/W	Letter 0 in ASCII format
REG_TAG_NAME_1	608	R/W	Letter 1 in ASCII format
REG_TAG_NAME_2	609	R/W	Letter 2 in ASCII format
REG_TAG_NAME_3	610	R/W	Letter 3 in ASCII format
REG_TAG_NAME_4	611	R/W	Letter 4 in ASCII format
REG_DEVICE_STATUS	622	R/W	0 = Auto 1 = Manual 2 = Test 3 = Powersave
REG_LN1_PHASES	623	R/W	0 = 1 phase 1 = 3 phases without N 2 = 3 phases with N
REG_RATED_VOLTAGE	624	R/W	0 = 100/57 V 1 = 115/66 V 2 = 120/70 V 3 = 208/120 V 4 = 220/127 V 5 = 230/132 V 6 = 240/138 V 7 = 277/160 V 8 = 347/200 V 9 = 380/220 V 10 = 400/230 V 11 = 415/240 V 12 = 440/254 V 13 = 480/277 V

Register	Address	R/W	Values
REG_RATED_FREQUENCY	625	R/W	1 = 50 Hz 2 = 60 Hz
REG_SECONDARY_LOAD	626	R/W	0 = Not Used 1 = Opening Only 2 = Opening And Closing 3 = Opening Pulse 4 = Opening/Closing Pulse
REG_GENERATOR_USAGE	627	R/W	0 = No Generator 1 = Generator In Use
REG_LINE_PRIORITY	628	R/W	0 = No Priority 1 = Line I - Switch 1 2 = Line II - Switch 2
REG_LANGUAGE	629	R/W	0 = English 1 = German 2 = French 3 = Italian 4 = Spanish 5 = Finnish 6 = Russian 7 = Chinese
REG_PASSWORD	630	R/W	0000...9999
REG_EXT_VT_PRESENT	631	R/W	0 = Absent 1 = Present
REG_EXT_VT_PRIMARY	632	R/W	0 = 100/57 V 1 = 115/66 V 2 = 120/70 V 3 = 208/120 V 4 = 220/127 V 5 = 230/132 V 6 = 240/138 V 7 = 277/160 V 8 = 347/200 V 9 = 380/220 V 10 = 400/230 V 11 = 415/240 V 12 = 440/254 V 13 = 480/277 V 14 = 500/288 V 15 = 550/317 V 16 = 600/347 V 17 = 660/380 V 18 = 690/400 V 19 = 910/525 V 20 = 950/550 V 21 = 1000/577 V 22 = 1150/660 V

Register	Address	R/W	Values
REG_EXT_VT_SECONDARY	633	R/W	0 = 100/57 V
			1 = 115/66 V
			2 = 120/70 V
			3 = 208/120 V
			4 = 220/127 V
			5 = 230/132 V
			6 = 240/138 V
			7 = 277/160 V
			8 = 347/200 V
			9 = 380/220 V
			10 = 400/230 V
			11 = 415/240 V
			12 = 440/254 V
			13 = 480/277 V
REG_LN2_PHASES	634	R/W	0 = 1 phase
			1 = 3 phases without N
			2 = 3 phases with N
REG_MANUAL_BACK_SWITCHING	635	R/W	0 = Off
			1 = On
REG_GENERATOR_SHUTDOWN	636	R/W	0 = Off
			1 = On
REG_AUTO_SWITCH_TO_O	637	R/W	0 = Off, 1: LN1, 2: LN2, 3: LN1 & LN2
			1 = LN1 to O
			2 = LN2 to O
			3 = LN1 & LN2 to O
REG_SWITCH_TYPE	638	R/W	0 = Automatic OTM_C_D
			1 = Motorized OTM_C
REG_DI4_FUNCTION	639	R/W	0 = No function
			1 = Emergency stop
			2 = Inhibit switching I to II
			3 = Remote control to O
			4 = Remote control to I
			5 = Remote control to II
			6 = Inhibit remote control
			7 = Generator alarm
			8 = Force commutation
			9 = External generator start
			10 = Status of secondary loads
			11 = Manual back switching mode
			12 = Remote reset
			13 = Line priority I
			14 = Line priority II
15 = External alarm			
REG_DI5_FUNCTION	640	R/W	See REG_DI4_FUNCTION values
REG_DI6_FUNCTION	641	R/W	See REG_DI4_FUNCTION values
REG_DI7_FUNCTION	642	R/W	See REG_DI4_FUNCTION values
REG_DI8_FUNCTION	643	R/W	See REG_DI4_FUNCTION values
REG_DI9_FUNCTION	644	R/W	See REG_DI4_FUNCTION values
REG_DI10_FUNCTION	645	R/W	See REG_DI4_FUNCTION values
REG_DI11_FUNCTION	646	R/W	See REG_DI4_FUNCTION values

Register	Address	R/W	Values
REG_DI4_CONTACT_TYPE	647	R/W	0 = NO 1 = NC
REG_DI5_CONTACT_TYPE	648	R/W	See REG_DI4_CONTACT_TYPE values
REG_DI6_CONTACT_TYPE	649	R/W	See REG_DI4_CONTACT_TYPE values
REG_DI7_CONTACT_TYPE	650	R/W	See REG_DI4_CONTACT_TYPE values
REG_DI8_CONTACT_TYPE	651	R/W	See REG_DI4_CONTACT_TYPE values
REG_DI9_CONTACT_TYPE	652	R/W	See REG_DI4_CONTACT_TYPE values
REG_DI10_CONTACT_TYPE	653	R/W	See REG_DI4_CONTACT_TYPE values
REG_DI11_CONTACT_TYPE	654	R/W	See REG_DI4_CONTACT_TYPE values
REG_DO6_FUNCTION	655	R/W	0 = No function 1 = Emergency/alarm 2 = Line I status 3 = Line II status 4 = Change-over switch alarm 5 = Manual mode 6 = Disconnect secondary loads 7 = Pre-transfer signal 8 = I Status 9 = O Status 10 = II Status
REG_DO7_FUNCTION	656	R/W	See REG_DO6_FUNCTION values
REG_DO8_FUNCTION	657	R/W	See REG_DO6_FUNCTION values
REG_DO9_FUNCTION	658	R/W	See REG_DO6_FUNCTION values
REG_DO10_FUNCTION	659	R/W	See REG_DO6_FUNCTION values
REG_DO12_FUNCTION	660	R/W	See REG_DO6_FUNCTION values
REG_DO6_CONTACT_TYPE	661	R/W	0 = NO 1 = NC
REG_DO7_CONTACT_TYPE	662	R/W	See REG_DO6_CONTACT_TYPE values
REG_DO8_CONTACT_TYPE	663	R/W	See REG_DO6_CONTACT_TYPE values
REG_DO9_CONTACT_TYPE	664	R/W	See REG_DO6_CONTACT_TYPE values
REG_DO10_CONTACT_TYPE	665	R/W	See REG_DO6_CONTACT_TYPE values
REG_DO12_CONTACT_TYPE	666	R/W	See REG_DO6_CONTACT_TYPE values
REG_VOLT_THRESHOLD_LN1_MIN	881	R/W	5...30 %
REG_VOLT_THRESHOLD_LN1_MAX	882	R/W	5...30 %
REG_VOLT_THRESHOLD_LN2_MIN	883	R/W	5...30 %
REG_VOLT_THRESHOLD_LN2_MAX	884	R/W	5...30 %
REG_VOLT_HYSTERESIS_LN1_MIN	885	R/W	4...29 %
REG_VOLT_HYSTERESIS_LN1_MAX	886	R/W	4...29 %
REG_VOLT_HYSTERESIS_LN2_MIN	887	R/W	4...29 %
REG_VOLT_HYSTERESIS_LN2_MAX	888	R/W	4...29 %
REG_FREQ_THRESHOLD_LN1_MIN	891	R/W	1...10 %
REG_FREQ_THRESHOLD_LN1_MAX	892	R/W	1...10 %
REG_FREQ_THRESHOLD_LN2_MIN	893	R/W	1...10 %
REG_FREQ_THRESHOLD_LN2_MAX	894	R/W	1...10 %
REG_FREQ_HYSTERESIS_LN1_MIN	895	R/W	8...98 (0.8 ... 9.8 %)
REG_FREQ_HYSTERESIS_LN1_MAX	896	R/W	8...98 (0.8 ... 9.8 %)
REG_FREQ_HYSTERESIS_LN2_MIN	897	R/W	8...98 (0.8 ... 9.8 %)
REG_FREQ_HYSTERESIS_LN2_MAX	898	R/W	8...98 (0.8 ... 9.8 %)

Register	Address	R/W	Values
REG_DELAY_TS	901	R/W	0...60 s
REG_DELAY_DS	902	R/W	0...60 s
REG_DELAY_TBS	903	R/W	0...5400 s
REG_DELAY_DBS	904	R/W	0...60 s
REG_DELAY_GS	905	R/W	0...1800 s
REG_DELAY_TT	906	R/W	0...600 s
REG_LCD_TIMER	907	R/W	0...3600 s
REG_DELAY_TP	908	R/W	0...120 s
REG_DELAY_TBP	909	R/W	0...120 s
REG_ALARM_EVENT_LOG_0	2000	R	Alarm / Event Log item 0
REG_ALARM_EVENT_LOG_1	2001	R	Alarm / Event Log item 1
REG_ALARM_EVENT_LOG_2	2002	R	Alarm / Event Log item 2
REG_ALARM_EVENT_LOG_3	2003	R	Alarm / Event Log item 3
REG_ALARM_EVENT_LOG_4	2004	R	Alarm / Event Log item 4
REG_ALARM_EVENT_LOG_5	2005	R	Alarm / Event Log item 5
REG_ALARM_EVENT_LOG_6	2006	R	Alarm / Event Log item 6
REG_ALARM_EVENT_LOG_7	2007	R	Alarm / Event Log item 7
REG_ALARM_EVENT_LOG_8	2008	R	Alarm / Event Log item 8
REG_ALARM_EVENT_LOG_9	2009	R	Alarm / Event Log item 9
REG_ALARM_EVENT_LOG_10	2010	R	Alarm / Event Log item 10
REG_ALARM_EVENT_LOG_11	2011	R	Alarm / Event Log item 11
REG_ALARM_EVENT_LOG_12	2012	R	Alarm / Event Log item 12
REG_ALARM_EVENT_LOG_13	2013	R	Alarm / Event Log item 13
REG_ALARM_EVENT_LOG_14	2014	R	Alarm / Event Log item 14
REG_ALARM_EVENT_LOG_15	2015	R	Alarm / Event Log item 15
REG_ALARM_EVENT_LOG_16	2016	R	Alarm / Event Log item 16
REG_ALARM_EVENT_LOG_17	2017	R	Alarm / Event Log item 17
REG_ALARM_EVENT_LOG_18	2018	R	Alarm / Event Log item 18
REG_ALARM_EVENT_LOG_19	2019	R	Alarm / Event Log item 19
REG_ALARM_EVENT_LOG_20	2020	R	Alarm / Event Log item 20
REG_ALARM_EVENT_LOG_21	2021	R	Alarm / Event Log item 21
REG_ALARM_EVENT_LOG_22	2022	R	Alarm / Event Log item 22
REG_ALARM_EVENT_LOG_23	2023	R	Alarm / Event Log item 23
REG_ALARM_EVENT_LOG_24	2024	R	Alarm / Event Log item 24
REG_ALARM_EVENT_LOG_25	2025	R	Alarm / Event Log item 25
REG_ALARM_EVENT_LOG_26	2026	R	Alarm / Event Log item 26
REG_ALARM_EVENT_LOG_27	2027	R	Alarm / Event Log item 27
REG_ALARM_EVENT_LOG_28	2028	R	Alarm / Event Log item 28
REG_ALARM_EVENT_LOG_29	2029	R	Alarm / Event Log item 29
REG_ALARM_EVENT_LOG_30	2030	R	Alarm / Event Log item 30
REG_ALARM_EVENT_LOG_31	2031	R	Alarm / Event Log item 31
REG_ALARM_EVENT_LOG_32	2032	R	Alarm / Event Log item 32
REG_ALARM_EVENT_LOG_33	2033	R	Alarm / Event Log item 33
REG_ALARM_EVENT_LOG_34	2034	R	Alarm / Event Log item 34
REG_ALARM_EVENT_LOG_35	2035	R	Alarm / Event Log item 35
REG_ALARM_EVENT_LOG_36	2036	R	Alarm / Event Log item 36
REG_ALARM_EVENT_LOG_37	2037	R	Alarm / Event Log item 37
REG_ALARM_EVENT_LOG_38	2038	R	Alarm / Event Log item 38
REG_ALARM_EVENT_LOG_39	2039	R	Alarm / Event Log item 39
REG_ALARM_EVENT_LOG_40	2040	R	Alarm / Event Log item 40

Register	Address	R/W	Values
REG_ALARM_EVENT_LOG_41	2041	R	Alarm / Event Log item 41
REG_ALARM_EVENT_LOG_42	2042	R	Alarm / Event Log item 42
REG_ALARM_EVENT_LOG_43	2043	R	Alarm / Event Log item 43
REG_ALARM_EVENT_LOG_44	2044	R	Alarm / Event Log item 44
REG_ALARM_EVENT_LOG_45	2045	R	Alarm / Event Log item 45
REG_ALARM_EVENT_LOG_46	2046	R	Alarm / Event Log item 46
REG_ALARM_EVENT_LOG_47	2047	R	Alarm / Event Log item 47
REG_ALARM_EVENT_LOG_48	2048	R	Alarm / Event Log item 48
REG_ALARM_EVENT_LOG_49	2049	R	Alarm / Event Log item 49
REG_TEST_DAY	7009	R/W	1...31
REG_TEST_MONTH	7010	R/W	1...12
REG_TEST_YEAR	7011	R/W	2011...9999

**Table 7.13**      **Modbus register map**

## 8 Technical data of the automatic control unit OMD800

Operating and measuring voltage area on 3 phase system:	
Main voltage	100 Vac - 480 Vac ( $\pm 20\%$ )
Phase voltage	57,7 Vac - 277 Vac ( $\pm 20\%$ )
AUX voltage	24 Vdc - 110 Vdc (-10 % to +15 %)
Frequency	50 Hz and 60 Hz ( $\pm 10\%$ )
Operating and measuring voltage area on 1 phase system:	
Phase voltage	57,7 Vac - 277 Vac <sup>1)</sup> ( $\pm 20\%$ )
AUX voltage	24 Vdc - 110 Vdc (-10 % to +15 %)
Frequency	50 Hz and 60 Hz ( $\pm 10\%$ )
Voltage and frequency sensing precision	
Voltage	1 %
Frequency	1 %
Relay utilization category	
X21, X22, X24	12 A, AC1, 250 V / 12 A, DC1, 24 V
X23	8 A, AC1, 250 V / 8 A, DC1, 24 V
X29	5 A, AC1, 250 V / 6 A, DC1, 24 V
Over voltage category	III, U <sub>imp</sub> 6 kV
IP rating	IP40 for the front panel
Temperature area	- 20 to + 60 °C
Transportation and storage temperature	- 25 to + 80 °C
Humidity	
with condensation	5 % - 98 %
without condensation	5 % - 90 %

<sup>1)</sup> If 1 phase system is used and the voltage level is between 57,7 Vac - 109 Vac the auxiliary power supply (AUX) must be used.

**Table 8.1**      **Technical Data of OMD800**

## 9 Troubleshooting OMD800

Alarms and events are presented with a dedicate message on the Alarm/Event Log.

Alarms are explained in the table below:

Message	Fault	Action	Value
Open 1 Failure	Switching from position I to position O fails. After 3 seconds the Alarm LED blinks.	The alarm can be reset by pressing the AUTO key. If the alarm activates again after trying to operate the switch, please check that the Motor/Manual selector of the change-over switch (only with motorized change-over switches OTM160...2500_CM) is in Motor (M) position and check the fuse (F1) of the motor operator.	1
Open 2 Failure	Switching from position II to position O fails. After 3 seconds the Alarm LED blinks.	The alarm can be reset by pressing the AUTO key. If the alarm activates again after trying to operate the switch, please check that the Motor/Manual selector of the change-over switch (only with motorized change-over switches OTM160...2500_CM) is in Motor (M) position and check the fuse (F1) of the motor operator.	2
Open SL	Device controlling opening of the secondary loads fails. After 3 seconds the Alarm LED blinks.	The alarm can be reset by pressing the AUTO key. If the alarm activates again after trying to operate the secondary load, please check status of the secondary load control device according to instructions provided by the manufacturer.	4
Close 1 Failure	Switching from position O to position I fails. After 3 seconds the Alarm LED blinks.	If the alarm activates again after trying to operate the switch, please check that the Motor/Manual selector of the change-over switch (only with motorized change-over switches OTM160...2500_CM) is in Motor (M) position and check the fuse (F1) of the motor operator.	8
Close 2 Failure	Switching from position O to position II fails. After 3 seconds the Alarm LED blinks.	If the alarm activates again after trying to operate the switch, please check that the Motor/Manual selector of the change-over switch (only with motorized change-over switches OTM160...2500_CM) is in Motor (M) position and check the fuse (F1) of the motor operator.	16
Close SL Failure	Device controlling closing of the secondary loads fails. After 3 seconds the Alarm LED blinks.	If the alarm activates again after trying to operate the secondary load, please check status of the secondary load control device according to instructions provided by the manufacturer.	32
Force Manual	Handle mounted.	Please check that the handle has been removed from the change-over switch and the change-over switch is not padlocked from the front panel.	256
External Fault	Both automatic transfer switch position status inputs are active.	Check connections between OMD and the change-over switch	512
External Alarm	External malfunction	Check the device connected to the external alarm input	1024
Generator Alarm	Generator malfunctioning.	Check generator according to instructions provided by the manufacturer.	4096

**Table 9.1** Alarms in OMD800

Events are explained in the table below:

Message	Description	Value
LN1 No Voltage	No voltage on line I	0
LN1 Undervoltage	Undervoltage on line I	1
LN1 Overvoltage	Overvoltage on line I	2
LN1 Phase Loss	Phase missing on line I	3
LN1 Unbalance	Voltage unbalance on line I	4
LN1 Phase Sequence	Incorrect phase sequence on line I	5
LN1 Inv. Frequency	Invalid frequency on line I	6
LN2 No Voltage	No voltage on line II	7
LN2 Undervoltage	Undervoltage on line II	8
LN2 Overvoltage	Overvoltage on line II	9
LN2 Phase Loss	Phase missing on line II	10
LN2 Unbalance	Voltage unbalance on line II	11
LN2 Phase Sequence	Incorrect phase sequence on line II	12
LN2 Inv. Frequency	Invalid frequency on line II	13
Opening I	Switching I -> O	14
Opening II	Switching II -> O	15
Opening Sec. Loads	Disconnecting secondary loads	16
Closing I	Switching O -> I	17
Closing II	Switching O -> II	18
Closing Sec. Loads	Connecting secondary loads	19
I Open	Switch I open	20
II Open	Switch II open	21
Sec. Loads Open	Secondary loads disconnected	22
I Closed	Switch I closed	23
II Closed	Switch II closed	24
Sec. Loads Closed	Secondary loads connected	25
Generator Started	Generator start activated	26
Generator Stopped	Generator stop activated	27
Handle attached	Changeover switch handle mounted	28
Handle Detached	Changeover switch handle dismantled	29
Force Commutation On	Force commutation signal activated	30
Force Commut. Off	Force commutation signal inactivated	31
Generator Start On	External generator start signal activated	32
Gen. Start Off	External generator start signal inactivated	33
Inhibit Switching On	Inhibit switching signal activated	34
Inhibit Sw. Off	Inhibit switching signal inactivated	35
Remote I On	Remote control to position I activated	36
Remote I Off	Remote control to position I inactivated	37
Remote O On	Remote control to position O activated	38
Remote O Off	Remote control to position O inactivated	39
Remote II On	Remote control to position II activated	40
Remote II Off	Remote control to position II inactivated	41
Manual BS (back switching) On	Manual back switching signal activated	46
Manual BS Off	Manual back switching signal inactivated	47
Emergency Stop On	Emergency stop signal active	42
Emergency Stop Off	Emergency stop signal inactive	43
Inhibit Remote On	Inhibit remote control signal active	44
Inhibit Remote Off	Inhibit remote control signal inactive	45

Message	Description	Value
Manual To Auto	Operating mode changed from Manual to Auto	48
Auto To Manual	Operating mode changed from Auto to Manual	49
Manual To Test	Operating mode changed from Manual to Test	50
Test To Manual	Operating mode changed from Test to Manual	51
Remote Reset On	Remote reset signal activated	52
Remote Reset Off	Remote reset signal inactivated	53
Pre-transfer Signal On	Pre-transfer signal activated	54
Pre-transfer Signal Off	Pre-transfer signal inactivated	55
Priority I Signal On	Priority I signal activated	56
Priority I Signal Off	Priority I signal inactivated	57
Priority II Signal On	Priority II signal activated	58
Priority II Signal Off	Priority II signal inactivated	59
External Alarm Signal On	External alarm signal activated	60
External Alarm Signal Off	External alarm signal inactivated	61

**Table 9.2 Events in OMD800**

Some of the events include information about current operating mode or event source. Information is presented with a capital letter in brackets after the event:

Letter	Source	Description	Value
M	Manual	Event initiated by user action in manual mode	1
A	Auto	Event initiated by automatic switching logic	2
T	Test	Event initiated by user action in test mode	3
H	Handle	Event initiated while handle attached	4
F	Fieldbus (Modbus)	Event initiated by fieldbus command	5
I	Digital Input	Event initiated by digital input	6

**Table 9.3 Event operating mode and source information**

Event/Alarm Log can be read through Modbus registers (see 7.2.3 OMD800 communication via Modbus). Return value of the register can be interpreted as following:

Alarm/Event flag	Event value	Event source
Bit 15 (1 = Event)	Bits 8-14 (see Table 9.2)	Bits 0-7 (See Table 9.3)

Alarm/Event flag	Event value
Bit 15 (0 = Alarm)	Bits 0-12 (see Table 9.1)

**9.1 Explanations of internal faults OMD800**

When digital Input 1 and 2 are both active, logic is locked and the Alarm LED is ON.

When digital Input 3 is active, logic is locked and the Alarm LED is ON.

**9.2 Change-over switch does not respond**

During the switching sequence, the OMD800 operates the change-over switch (Switch I) first to the position O from position I. If this transition is not completed in three seconds, the Open 1 Failure is activated. If switching to the position O is completed, but the transition (Switch II) from O to II fails, the Close 2 Failure is activated. These alarms will lock the switching logic and can only be reset by pushing the AUTO key.

During the back switching sequence, similar transitions will be performed from II to O and from O to I, possibly activating Open 2 Failure or Close 1 Failure.

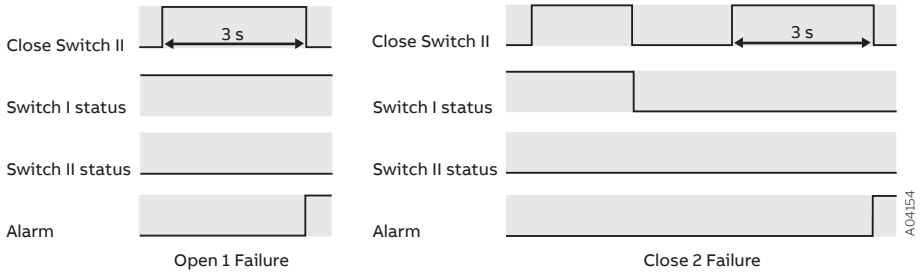

**Figure 9.1 Unsuccessful switching sequence**

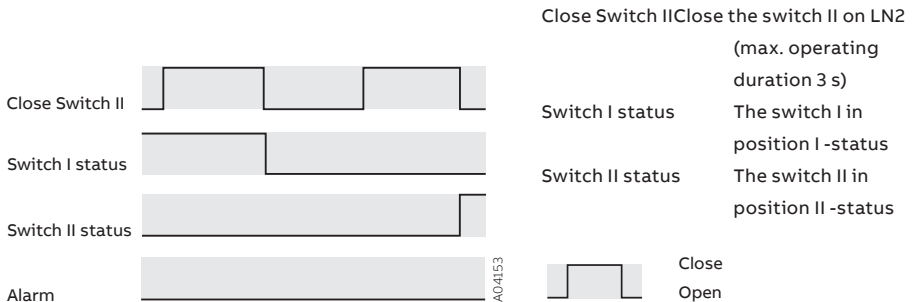

**Figure 9.2 Successful switching sequence**

**9.3 Missing of both lines**

The missing of both lines is indicated by a blinking Power LED. In this case, the OMD800 will be in a power saving state. If both lines are missing more than one minute, the OMD800 will shut down.

# 10 Accessories

## 10.1 Fastener

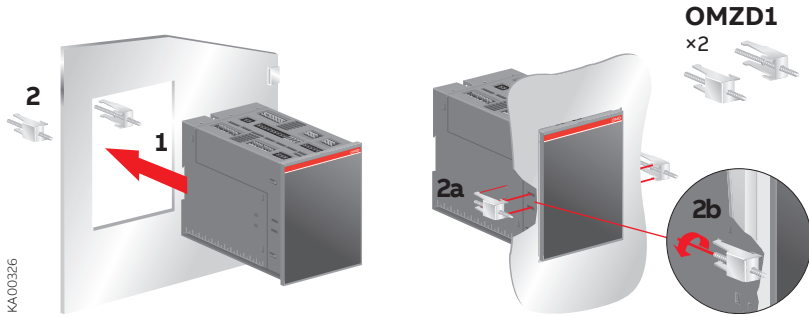

Figure 10.1 Fastener OMZD1, used when the automatic control unit OMD800 is mounted on the door

### 10.2 Cover plate

OMZC2  
IP54

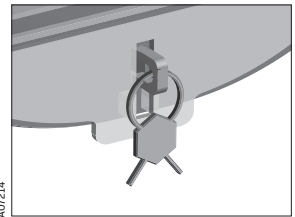
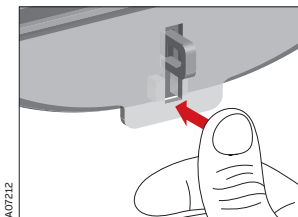
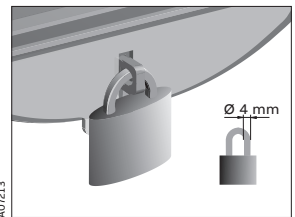
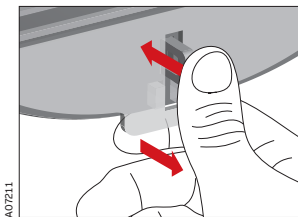
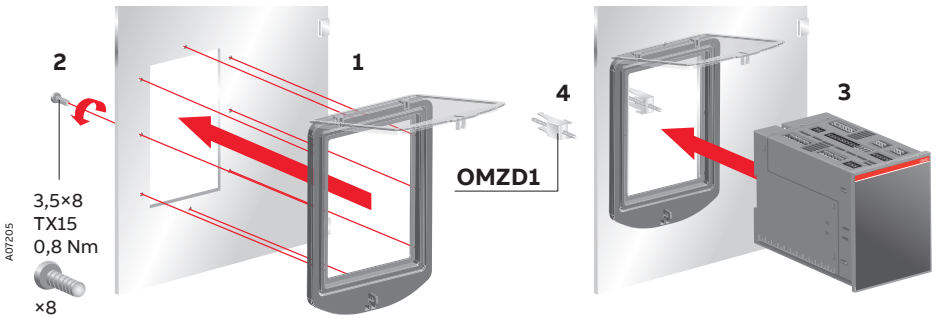
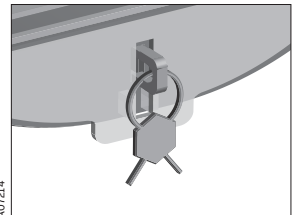
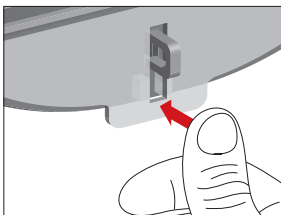
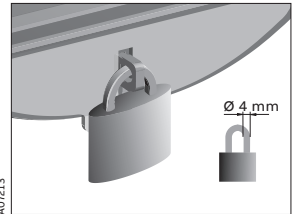
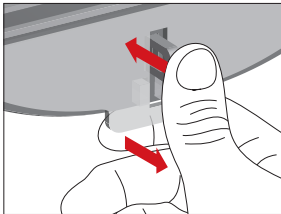
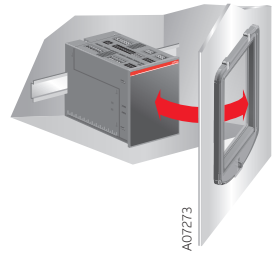
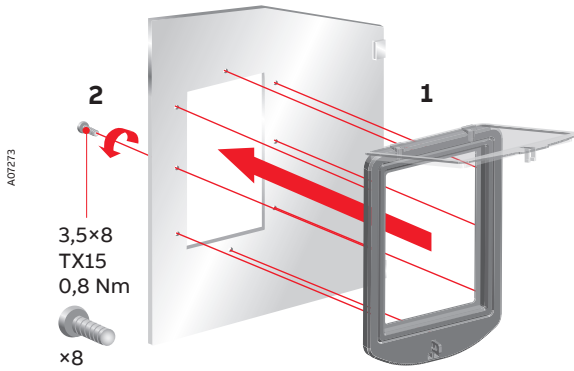
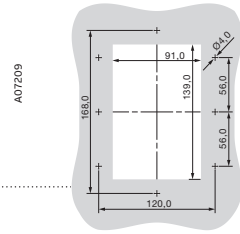
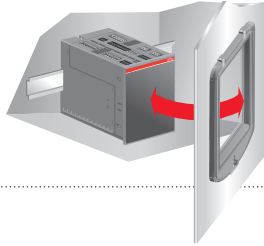

Figure 10.2 Door drilling and mounting of the cover plate OMZC2 , when the automatic control unit OMD800 is mounted on the door

OMZC2  
IP54



**Figure 10.3** Door drilling and mounting of the cover plate OMZC2 , when the automatic control unit OMD800 is mounted on the DIN-rail





<b>BG</b>	Внимание! Опасно напрежение! Да се монтира само от лице с електротехническа квалификация.
<b>CN</b>	警告！电压危险！只能由专业电工进行安装。
<b>CZ</b>	Varování! Nebezpečné napětí! Montáž smí provádět výhradně elektrotechnik!
<b>DA</b>	Advarsel! Farlig elektrisk spænding! Installation må kun foretages af personer med elektroteknisk ekspertise.
<b>DE</b>	Warnung! Gefährliche Spannung! Installation nur durch elektrotechnische Fachkraft.
<b>EL</b>	Προειδοποίηση! Υψηλή τάση! Η εγκατάσταση πρέπει να γίνεται μόνο από εξειδικευμένους ηλεκτροτεχνικούς.
<b>EN</b>	Warning! Hazardous voltage! Installation by person with electrotechnical expertise only.
<b>ES</b>	¡Advertencia! ¡Tensión peligrosa! La instalación deberá ser realizada únicamente por electricistas especializados.
<b>ET</b>	Hoiatus! Ohtlik pinge. Paigaldada võib ainult elektrotehnika-alane ekspert.
<b>FI</b>	Varoitus! Vaarallinen jännite! Asennuksen voi tehdä vain sähköalan ammattihenkilö.
<b>FR</b>	Avertissement! Tension électrique dangereuse! Installation uniquement par des personnes qualifiées en électrotechnique
<b>HR</b>	Upozorenje! Opasan napon! Postavljati smije samo elektrotehnički stručnjak.
<b>HU</b>	Figyelmeztetés! Veszélyes feszültség! Csak elektrotechnikai tapasztalattal rendelkező szakember helyezheti üzembe.
<b>IE</b>	Rabhadh! Voltas gaiseach! Ba chóir do dhuine ag a bhfuil saineolas leictreicniúil, agus an té sin amháin, é seo a shuiteáil.
<b>IT</b>	Avvertenza! Tensione pericolosa! Fare installare solo da un elettricista qualificato.
<b>LT</b>	Dėmesio! Pavojinga įtampa! Dirbti leidžiama tik elektrotechniko patirties turintiems asmenims.
<b>LV</b>	Uzmanību! Bīstami - elektrība! Montāžas darbus drīkst veikt tikai personas, kurām ir atbilstošas elektrotehniskās zināšanas.
<b>MT</b>	Twissija! Vultaġġ perikoluż! Ghandu jiġi installat biss minn persuna b'kompetenza elettroteknika.
<b>NL</b>	Waarschuwing! Gevaarlijke spanning! Mag alleen geïnstalleerd worden door een deskundige elektrotechnicus.
<b>NO</b>	Advarsel! Farlig spenning! Montering skal kun utføres av kvalifiserte personer med elektrokompetanse.
<b>PL</b>	Ostrzeżenie! Niebezpieczne napięcie! Instalacji może dokonać wyłącznie osoba z fachową wiedzą w dziedzinie elektrotechniki.
<b>PT</b>	Aviso! Tensão perigosa! A instalação só deve ser realizada por um electricista especializado.
<b>RO</b>	Avvertizare! Tensiune periculoasă! Instalarea trebuie efectuată numai de către o persoană cu experiență în electrotehnică.
<b>RU</b>	Осторожно! Опасное напряжение! Монтаж должен выполняться только специалистом-электриком.
<b>SE</b>	Varning! Farlig spänning! Installation får endast utföras av en elektriker.
<b>SK</b>	Varovanie! Nebezpečné napätie! Montáž môže vykonávať iba skúsený elektrotechnik.
<b>SL</b>	Opozorilo! Nevarna napetost! Vgradnjo lahko opravi le oseba z elektrotehničnim strokovnim znanjem.



---

## Contact us

### **ABB Oy**

Muottitie 2A, 65320

Vaasa Finland

**[abb.com/lowvoltage](http://abb.com/lowvoltage)**