

INSTALLATION AND OPERATING INSTRUCTION

Automatic control units OMD200 and 300



Table of contents

1	Introduction	05
1.1	Use of symbols	05
1.2	Explanations of abbreviations and terms	05
2	Product overview	06
2.1	Typical applications	07–08
3	Description	09
3.1	OMD200 and OMD300 switching sequence	09
3.1.1	Line 1 priority	09
3.1.2	No line priority	10
3.1.3	Manual back switching mode	11
4	Installation	12
4.1	Dimensional drawings	12
4.2	Mounting	12
4.2.1	Door mounting	12–13
4.2.2	DIN-rail mounting	14–15
5	Connecting	16
5.1	Power circuit	16
5.2	Control circuit	17
5.2.1	Control circuit diagram OMD200 with motorized OTM40...125_CMA_	17
5.2.2	Control circuit diagram OMD200 with motorized OTM160...2500_CM_	18
5.2.3	Connectors, OMD200	19
5.2.4	Control circuit diagram OMD300 with motorized OTM40...125_CMA_	20
5.2.5	Control circuit diagram OMD300 with motorized OTM160...2500_CM_	21
5.2.6	Connectors, OMD300	22
5.2.7	OMD200 and OMD300 outputs	23
5.2.8	OMD200 and OMD300 inputs	23

6	Operating	24
6.1	Automatic control unit in Manual Mode	24-25
6.2	Automatic control unit in Automatic Mode	26
6.3	Selection of delay time, voltage threshold and TEST function	26-28
6.4	Operating modes	29
6.4.1	Operating modes in OMD200 and 300	29
6.4.2	Choice of Operating mode in OMD200 and OMD300	30-32
7	Using automatic control units OMD200 and OMD300	33
7.1	Interface	33
7.1.1	Keypad	33-34
7.1.2	LEDs	34-35
7.2	Configuration	36
7.2.1	Rotary switches	36
7.2.2	DIP switches / parameter set	37-39
7.3	TEST sequence	40
8	Technical data of the automatic control units OMD200 / OMD300	41
9	Troubleshooting	42
9.1	OMD200, OMD300	42
9.2	Explanations of internal faults OMD200, OMD300	42
9.3	Change-over switch does not respond	43
9.4	Missing of both lines	43
10	Accessories	44
10.1	Fastener	44
10.2	Cover plate	45-46

AUTOMATIC CONTROL UNITS, OMD200 AND 300

1 Introduction

This manual describes the installation and the basic operation of the OMD200 and OMD300 automatic control units. The instructive part is followed by a section on available accessories.

1.1 Use of symbols



Hazardous voltage: warns about a situation where a hazardous voltage may cause physical injury to a person or damage to equipment.



General warning: warns about a situation where something other than electrical equipment may cause physical injury to a person or damage to equipment.



Caution: provides important information or warns about a situation that may have a detrimental effect on equipment.



Information: provides important information about the equipment.

1.2 Explanations of abbreviations and terms

OMD:	The control unit of automatic transfer switching equipment, common type name for the automatic control unit
OMD200:	The automatic control unit, standard version
OMD300:	The automatic control unit, standard version with additional power supply control
DPS:	Dual power source
LN1-Switch I:	Power supply line, eg. the primary line
LN2-Switch II:	Power supply line, eg. the secondary line used in emergency cases
Test sequence:	A sequence to test the functionality of the OMD and the connected change-over switch
Ts:	Switching delay
TBs:	Back switching delay
Gs:	Generator stop delay

2 Product overview

The automatic transfer switch concept is applied to any application requiring switching from the primary power line to secondary power line to ensure the supply of loads.

OMD200:

Analysing the voltage, frequency and the phase balance. Includes the generator START / STOP command.

OMD200 has two sensors to monitor two three-phase power lines, both able to work with single phase, too. It has the capability to monitor two power supply lines and to manage a single change-over switch. With DIP-switches it can be chosen whether or not the neutral line is connected. If OMD200 is used without the neutral line, the external transformer must be used.

OMD300:

Analysing the voltage, frequency and the phase balance. Includes the generator START / STOP command and the dual power supply (DPS) to motor operator.

OMD300 has two sensors to monitor two three-phase power lines, both able to work with single phase, too. It has the capability to monitor two power supply lines and to manage a single change-over switch. OMD300 has integrated voltage supply for the motor operator (Dual power source, DPS). The neutral line has to be always connected.

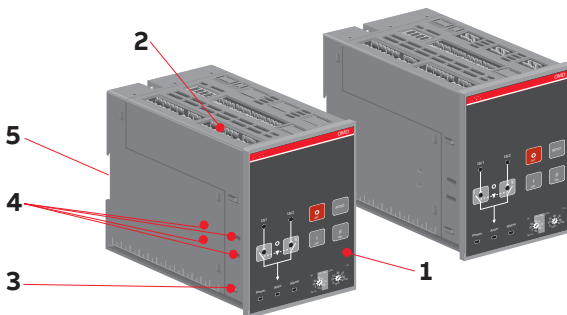

Figure 2.1 Automatic control units, OMD200 and OMD300

- 1 User interface consists of LEDs, keypad and rotary switches
- 2 Connectors to connect automatic control unit with application and motorized change-over switch
- 3 DIP switches for parameter setting
- 4 Places for fastener, used when OMD200 or OMD300 is mounted on the door
- 5 Place for DIN rail

2.1 Typical applications

A. Mains - Generator line

In case of loss of the primary power line, the OMD_ device manages the switching to the emergency power line equipped with a genset system.

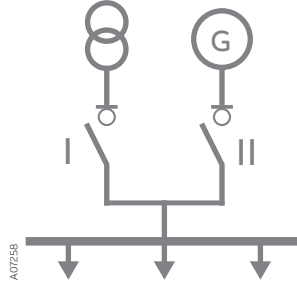

Figure 2.2 Mains - Generator line

B. Mains a – Mains b

In case of loss of the primary power line, the OMD_ device manages the switching to a secondary power line used as an emergency source.

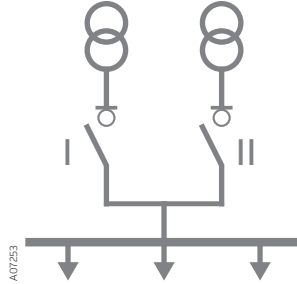

Figure 2.3 Mains a – Mains b

Automatic control unit type OMD_ is designed for single and three-phase distribution systems in diverse applications. OMD_ is supplied from Line 1 and Line 2 and can be used without external power supply.

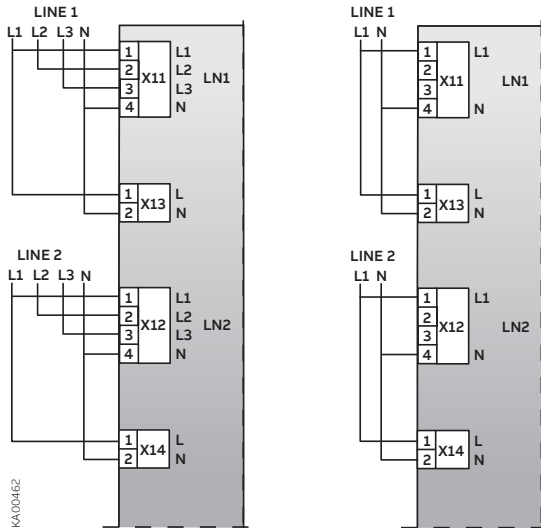

Figure 2.4 Automatic control units OMD_ have the capability to monitor two three-phase power lines, both able to also work with single phase.

With DIP switches, it can be chosen whether or not the N-line is connected. If OMD_ is used without the N-line, the external transformer must be used.

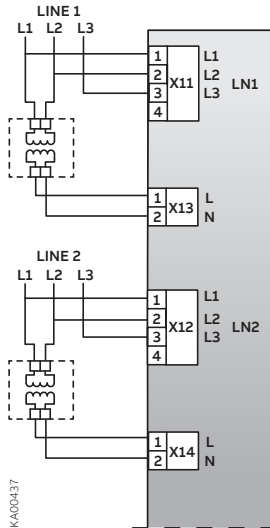

Figure 2.5 If OMD_ is used without the N-line, the external transformer must be used.

3 Description

3.1 OMD200 and OMD300 switching sequence

3.1.1 Line 1 priority

The switching sequence can be summarized in following steps:

- ▶ An anomaly occurs on the Line 1
- ▶ Switching delay
- ▶ Generator start
- ▶ Change-over switch (Switch I) to the position O
- ▶ Change-over switch (Switch II) to the position II

And the back switching sequence can be summarized in the following steps:

- ▶ The Line 1 will start the normal functioning
- ▶ Back switching delay
- ▶ Change-over switch (Switch II) to the position O
- ▶ Change-over switch (Switch I) to the position I
- ▶ Generator stop delay
- ▶ Generator stop

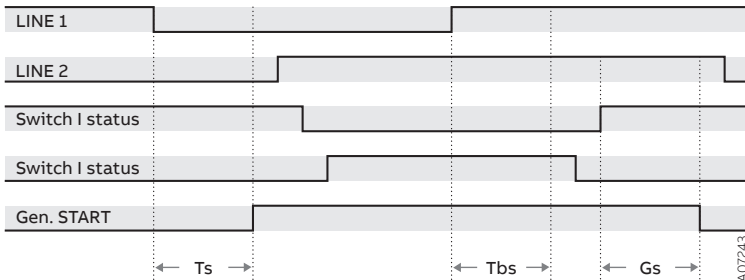

T_s : Switching delay, T_{bs} : Back switching delay, G_s : Generator stop delay

Figure 3.1 Automatic Switching Sequence, Line 1 priority

3.1.2 No line priority

The switching sequence can be summarized in following steps:

- ▶ An anomaly occurs on the Line 1
- ▶ Switching delay
- ▶ Generator start
- ▶ Change-over switch (Switch I) to the position O
- ▶ Change-over switch (Switch II) to the position II

And the back switching sequence can be summarized in the following steps:

- ▶ The Line 1 will start the normal functioning
- ▶ Change-over switch stays in position II
- ▶ An anomaly occurs on the Line 2
- ▶ Back switching delay
- ▶ Change-over switch (Switch II) to the position O
- ▶ Change-over switch (Switch I) to the position I
- ▶ Generator stop delay
- ▶ Generator stop

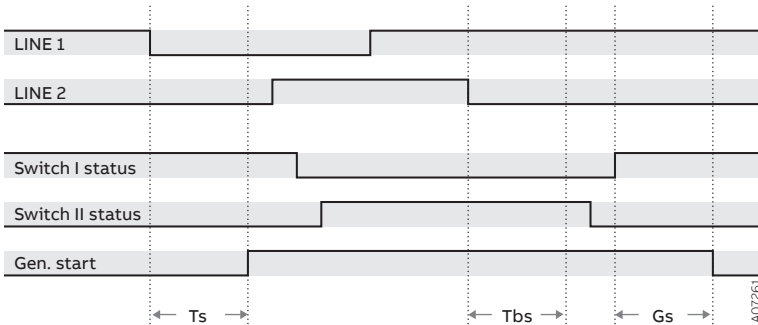

T_s : Switching delay, T_{bs} : Back switching delay, G_s : Generator stop delay

Figure 3.2 Automatic Switching Sequence, no line priority

3.1.3 Manual back switching mode

The switching sequence of OMD200 and OMD300 can be summarized in following steps:

- ▶ An anomaly occurs on the Line 1
- ▶ Switching delay
- ▶ Generator start
- ▶ Change-over switch (Switch I) to the position O
- ▶ Change-over switch (Switch II) to the position II

And the back switching sequence can be summarized in the following steps:

- ▶ The Line 1 will start the normal functioning
- ▶ Change-over switch stays in position II
- ▶ An anomaly occurs on the Line 2
- ▶ Back switching delay
- ▶ Change-over switch (Switch II) to the position O
- ▶ The Line 2 will start the normal functioning
- ▶ Switching delay
- ▶ Change-over switch (Switch II) to the position II

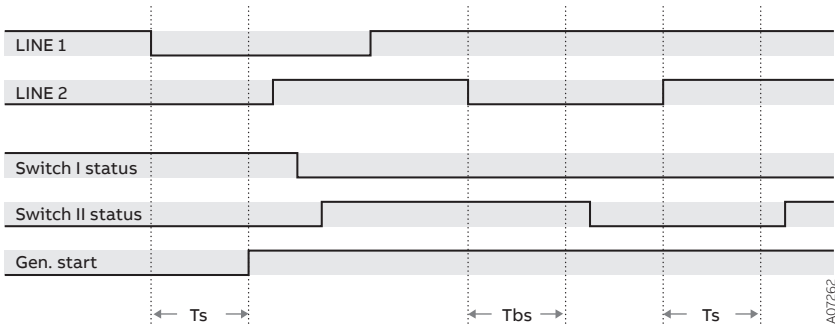

T_s : Switching delay, T_{bs} : Back switching delay

Figure 3.3 Automatic Switching Sequence, manual back switching mode

4 Installation

4.1 Dimensional drawings

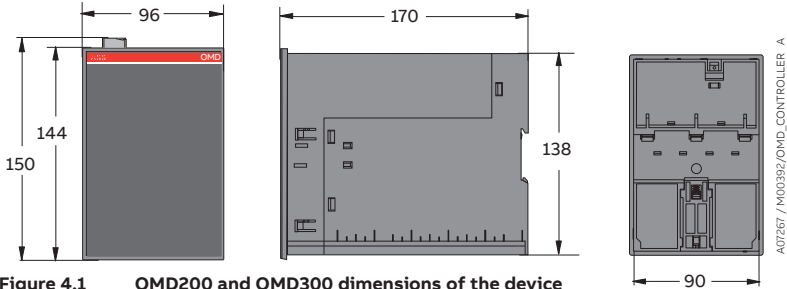

Figure 4.1 OMD200 and OMD300 dimensions of the device

4.2 Mounting

4.2.1 Door mounting

The automatic control unit OMD_ can be mounted on the door with the fastener OMZD1, see Accessories, Section 10. Door drilling according to Figure 4.2. As an optional extra you can use the cover plate OMZC2 on the door for OMD200 and 300, see Figure 4.3 on next page and Accessories, Section 10.

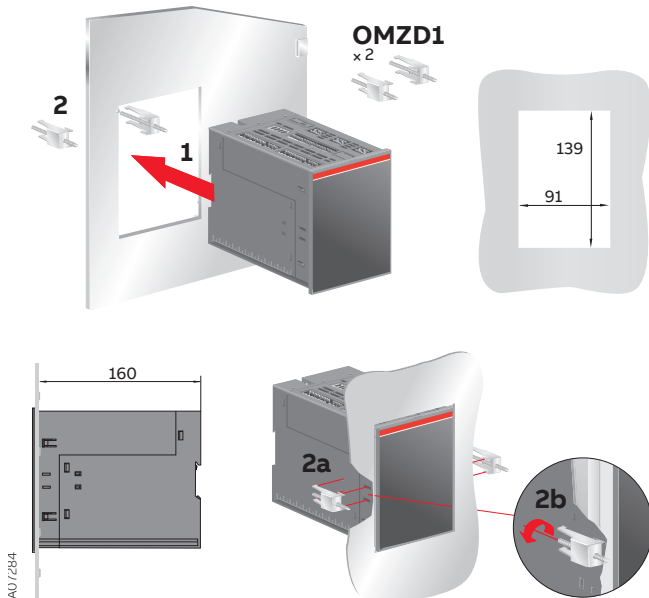

Figure 4.2 Automatic control unit OMD_, door mounting, door drilling

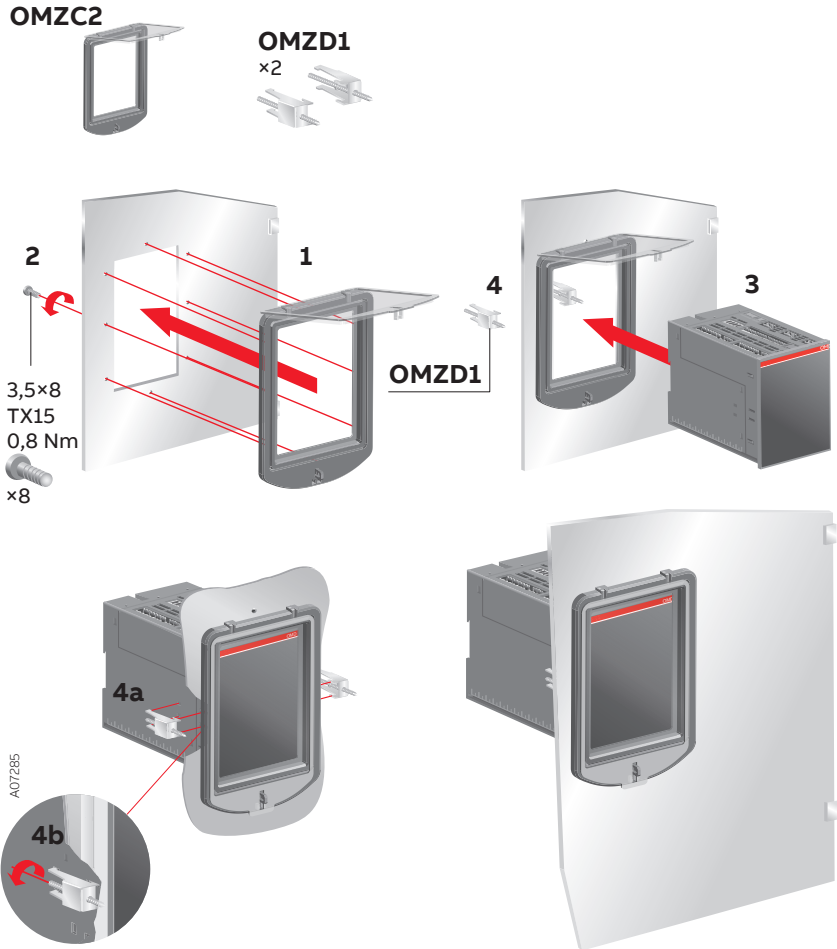

Figure 4.3 Automatic control unit OMD200 and 300, door mounting with the cover plate, door drilling for the cover plate OMZC2, see Accessories, Section 10

4.2.2 DIN-rail mounting

The automatic control unit OMD_ can be mounted on the 35 mm DIN-rail, see the Figure 4.4. Door drilling, if needed, according to Figure 4.4. As an optional extra you can use the cover plate OMZC2 on the door for OMD200 and OMD300, see Figure 4.5 and Accessories, Section 10.

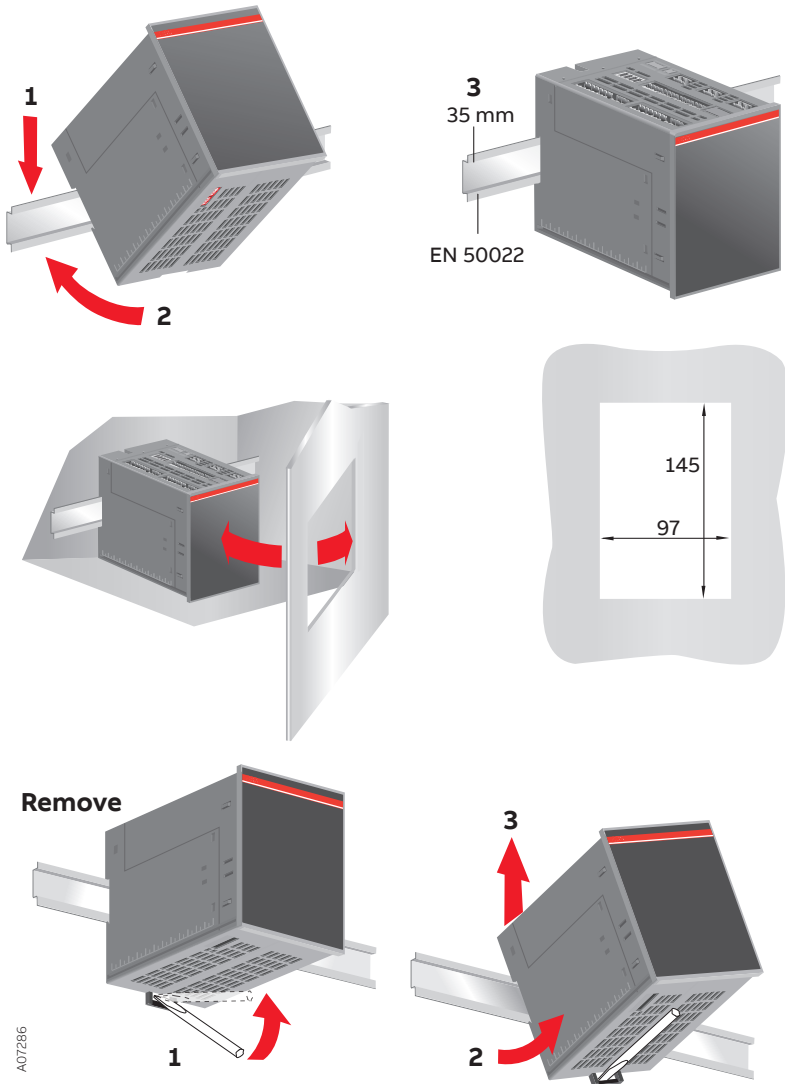

Figure 4.4 Automatic control unit OMD_, DIN-rail mounting, door drilling

A07286

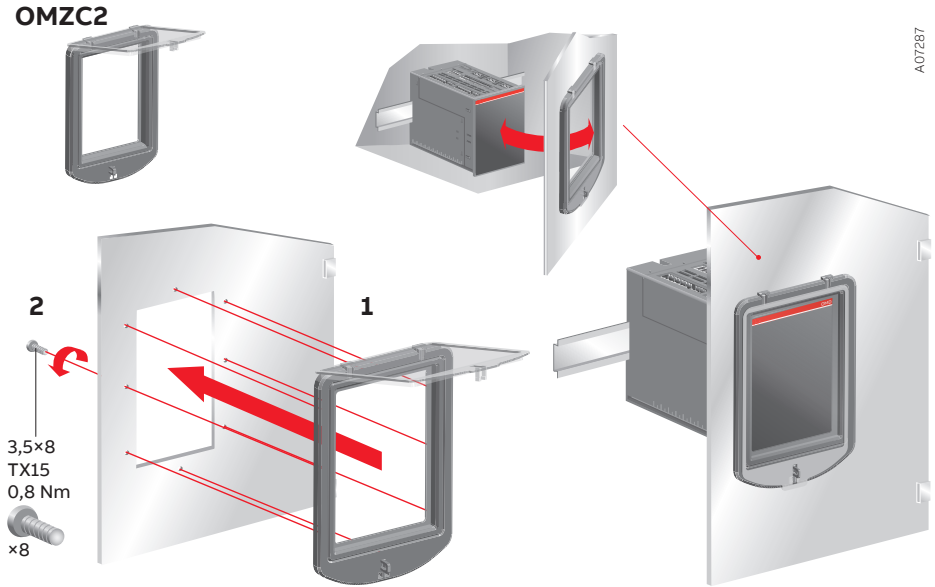

Figure 4.5 Automatic control unit OMD_, DIN-rail mounting with the cover plate, door drilling for the cover plate OMZC2, see Accessories, Section 10

5 Connecting



Only an authorised electrician may perform the electrical installation and maintenance of automatic transfer switches. Do not attempt any installation or maintenance actions when an automatic transfer switch is connected to the electrical mains. Before starting work, make sure that the switch is de-energised.

5.1 Power circuit

Operating voltage:

Main voltage:	208 Vac - 480 Vac	(±20 %)
Phase voltage:	120 Vac - 277 Vac	(±20 %)
Frequency:	50 Hz - 60 Hz	(±10 %)

Phase setting with DIP switches: Single phase or Three-phase (default).

OMD200:

If the automatic control unit OMD200 is used without neutral (three-phase connection), the external transformer must be used. The transformer will drop the main voltage to the phase voltage level. Neutral has to be connected when using a single phase connection.

OMD300:

Neutral must always be connected.

5.2 Control circuit

5.2.1 Control circuit diagram OMD200 with motorized OTM40...125_CMA_

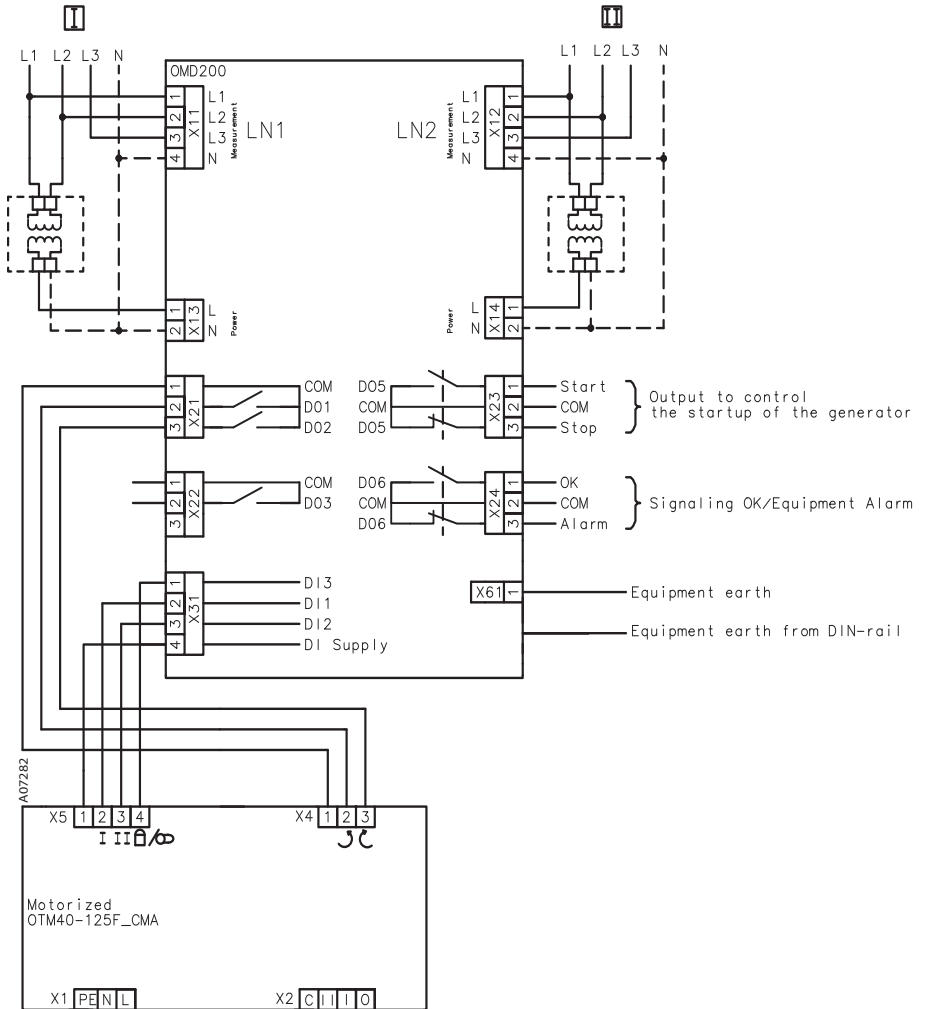

Figure 5.1 Control circuit diagram OMD200 with motorized OTM40...125_CMA_



Equipment earth must always be connected.

5.2.2 Control circuit diagram OMD200 with motorized OTM160...2500_CM_

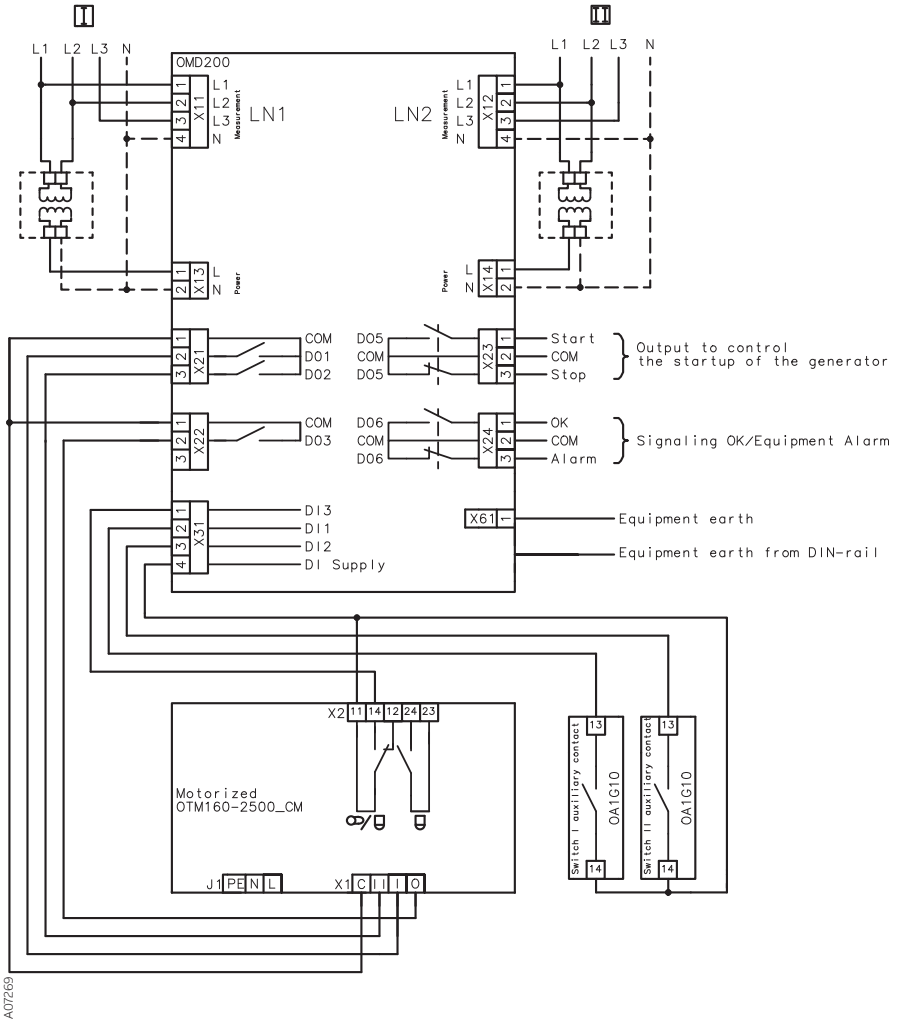

Figure 5.2 Control circuit diagram OMD200 with motorized OTM160...2500_CM_



Equipment earth must always be connected.

5.2.3 Connectors, OMD200

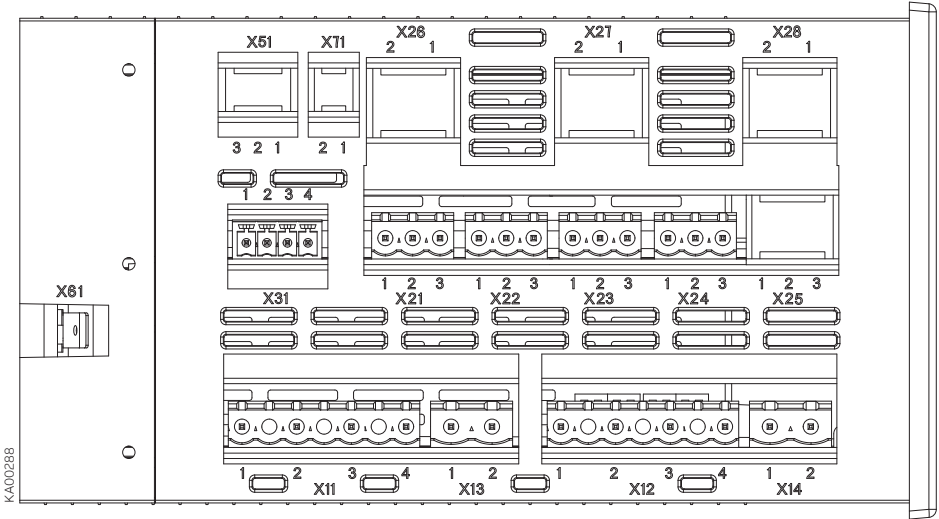

Figure 5.3 Connectors, OMD200

Connector	Description	
X11:1	Supply I: L1	
X11:2	Supply I: L2	
X11:3	Supply I: L3	
X11:4	Supply I: N	
X13:1	Supply I (power supply): L1 (default)	
X13:2	Supply I (power supply): N	
X12:1	Supply II: L1	
X12:2	Supply II: L2	
X12:3	Supply II: L3	
X12:4	Supply II: N	
X14:1	Supply II (power supply): L1 (default)	
X14:2	Supply II (power supply): N	
X21:1	Voltage supply from motor operator OME_	Common
X21:2	Output to close switch I or open switch II	NO
X21:3	Output to close switch II or open switch I	NO
X22:1	Voltage supply from motor operator OME_	Common
X22:2	Output to O command with switch type OTM160...2500_CM_	NO
X22:3	Reserved	
X23:1	Output to control the start of the generator,	NO
X23:2	Common	
X23:3	Output to control the stop of the generator,	NC
X24:1	Output to signal OK (no alarm)	
X24:2	Common	
X24:3	Output to signal Alarm	
X31:1	Manual / Alarm input from handle	
X31:2	Status of switch I auxiliary contact	
X31:3	Status of switch II auxiliary contact	
X31:4	Voltage supply from the automatic control unit OMD_	
X61	Equipment earth	

Table 5.1 Connectors OMD200

5.2.4 Control circuit diagram OMD300 with motorized OTM40...125_CMA_

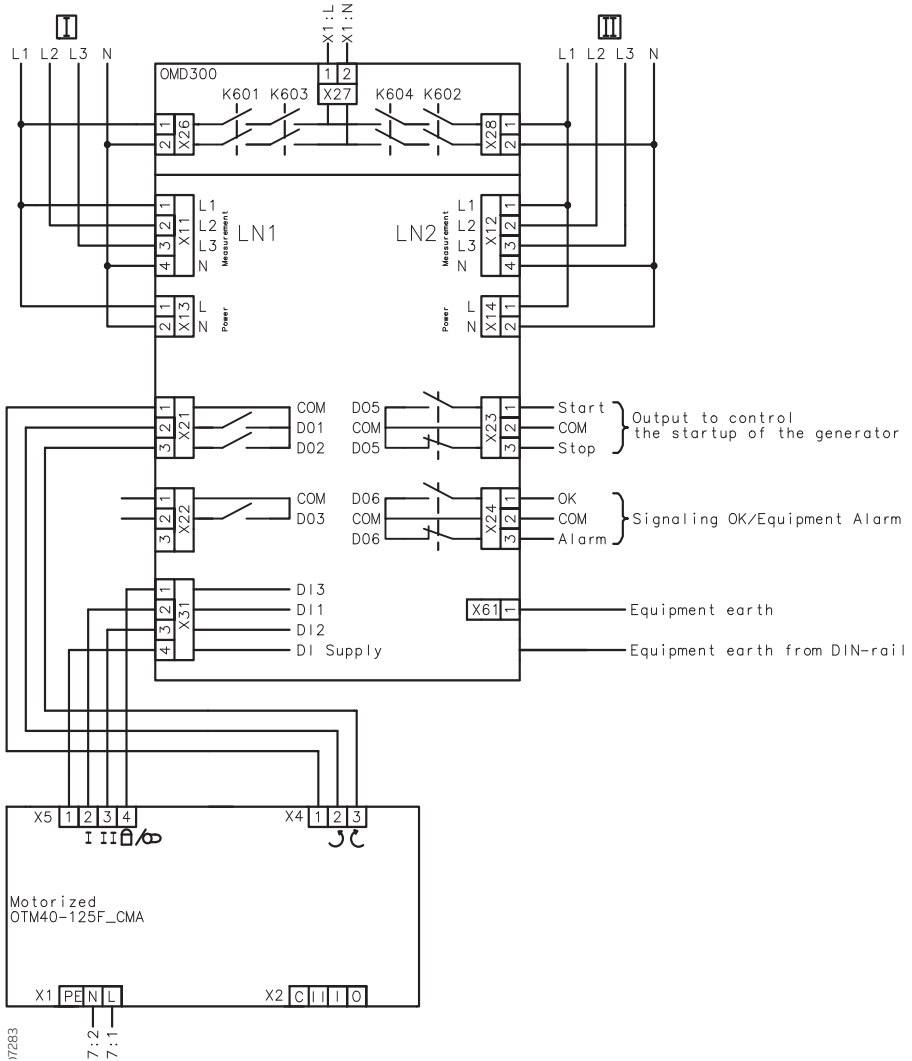

Figure 5.4 Control circuit diagram OMD300 with motorized OTM40...125_CMA_



Equipment earth must always be connected.

5.2.5 Control circuit diagram OMD300 with motorized OTM160...2500_CM_

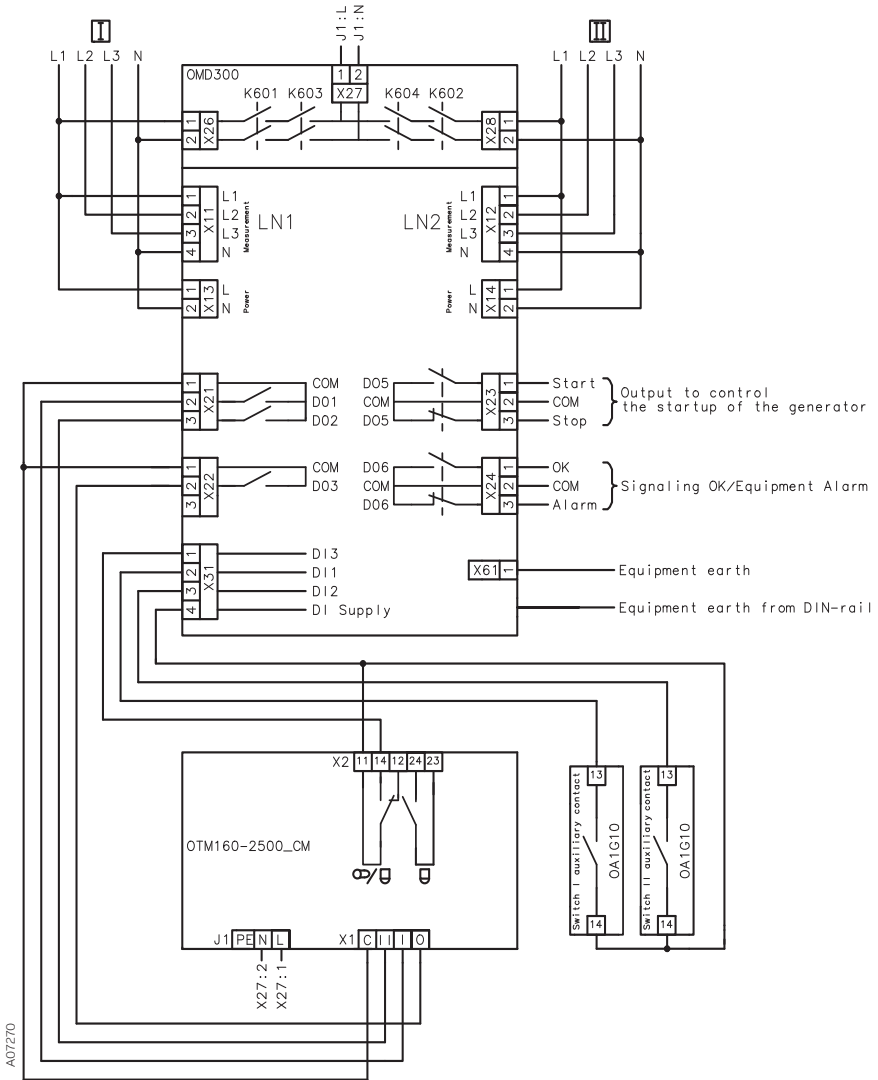

Figure 5.5 Control circuit diagram OMD300 with motorized OTM160...2500_CM_



Equipment earth must always be connected.

5.2.6 Connectors, OMD300

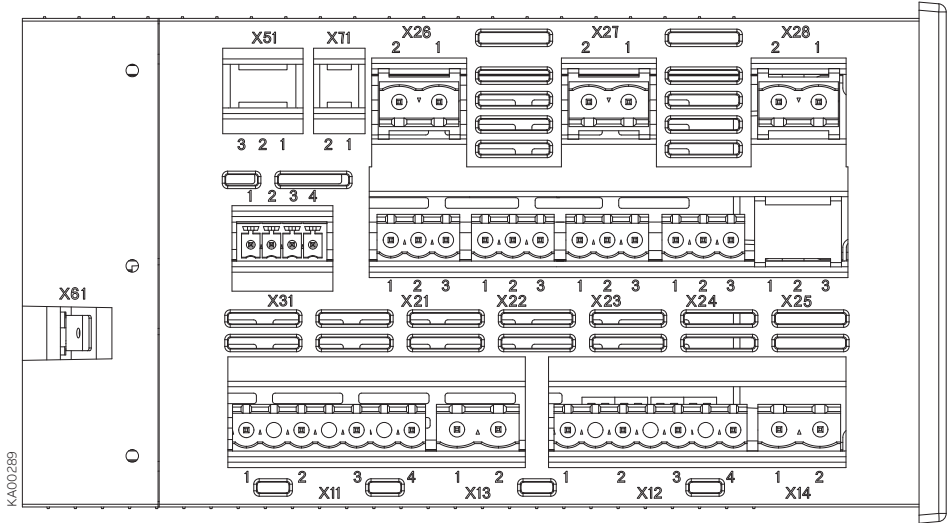

Figure 5.6 Connectors, OMD300

Con- nector	Description	Con- nector	Description
X11:1	Supply I: L1	X24:1	Output to signal OK (no alarm)
X11:2	Supply I: L2	X24:2	Common
X11:3	Supply I: L3	X24:3	Output to signal Alarm
X11:4	Supply I: N	X31:1	Manual / Alarm input from handle
X13:1	Supply I (power supply): L1 (default)	X31:2	Status of switch I auxiliary contact
X13:2	Supply I (power supply): N	X31:3	Status of switch II auxiliary contact
X12:1	Supply II: L1	X31:4	Voltage supply from automatic control unit
X12:2	Supply II: L2	X26:1	Supply I: L1
X12:3	Supply II: L3	X26:2	Supply I: N
X12:4	Supply II: N	X27:1	Motor: L
X14:1	Supply II (power supply): L1 (default)	X27:2	Motor: N
X14:2	Supply II (power supply): N	X28:1	Supply II: L1
X21:1	Voltage supply from motor operator OME_	X28:2	Supply II: N
X21:2	Common	X61	Equipment earth
X21:3	Output to close switch I or open switch II		
	Output to close switch II or open switch I		
X22:1	Voltage supply from motor operator OME_		
	Common		
X22:2	Output to O command with switch type		
	OTM 160...2500_CM_		
X22:3	Reserved		
X23:1	Output to control the start of the generator		
X23:2	Common		
X23:3	Output to control the stop of the generator		

Table 5.2 Connectors OMD300

5.2.7 OMD200 and OMD300 outputs

5.2.7.1 Opening/closing command to change-over switches, X21 (DO1-DO2) and X22 (DO3)

These outputs command the change-over switch to open and close Switch I or Switch II.

To guarantee the highest-level safety OMD_ monitors the correct operation of the change-over switch after a command has been sent. If the feedback of the switch status is not received within 3 seconds of the sending of the command, the device considers it as a failed command and operates as follows:

- ▶ An alarm is generated: DO6 activate.
- ▶ Alarm LED is blinking.
- ▶ Alarm is set off by pushing the AUTO key. After that the device is always in the Manual Mode to prevent unwanted operation of the change-over switch.

Exactly the same operations are performed on the secondary line (LN2-Switch II) during the back switching sequence.

5.2.7.2 Gen-Set start/stop, X23 (DO5)

Gen-Set start and stop is handled by a bistable relay. When the relay contact Start (X23:1) is closed, the generator is started. When the relay contact Stop (X23:3) is closed, the generator is stopped.

5.1.7.3 Alarm signaling, X24 (DO6)

When the relay contact Alarm (X24:3) is open and contact OK (X24:1) is closed, the automatic transfer logic is enabled. If the relay contact Alarm (X24:3) is closed and the contact OK (X24:1) is open the automatic transfer logic is disabled and an alarm is active.

5.2.8 OMD200 and OMD300 inputs

5.2.8.1 Switch status input, X31:2 (DI1), X31:3 (DI2)

These two inputs are connected to change-over switch auxiliary contacts. Input X31:2 (DI1) is connected to LN1-Switch I and input X31:3 (DI2) is connected to LN2-Switch II (Switch I / II open = input inactive, Switch I / II closed = input active). Auxiliary contacts are in-built in motorized OTM40...125_CMA_. If OMD_ is used with motorized OTM160...2500_CM_, use always type OA1G10 auxiliary contacts with DI1 and DI2. See the wiring diagrams on Figure 5.1, Figure 5.2, Figure 5.4 and Figure 5.5.

5.2.8.2 Force manual, X31:1 (DI3)

When the handle is attached this input is closed and OMD_ is forced to Manual Mode. To set the OMD_ back to the Automatic Mode the handle must be removed and the AUTO key pushed (Auto LED is ON).

6 Operating



Never open any covers on the product. There may be dangerous external control voltages inside the automatic transfer switch even if the voltage is turned off.



Never handle control cables when the voltage of the automatic transfer switch or external control circuits are connected.



Exercise sufficient caution when handling the unit.

6.1 Automatic control unit in Manual Mode

Selecting the automatic control unit OMD_ to the Manual Mode:

- a Make sure that the power LED is ON, see the Figure 6.1/①.
- b If the Auto LED is OFF /②, the automatic control unit is in Manual Mode.
- c If the Auto LED is ON, push the Auto key once /③. EI LED The Auto LED switches to OFF and the automatic control unit OMD_ is in Manual Mode /④.

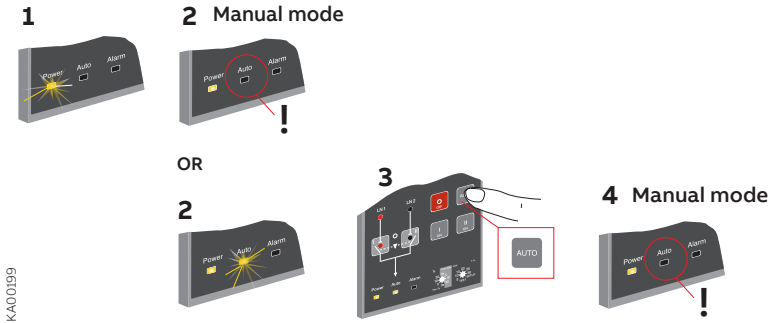

Figure 6.1 Selecting the automatic control unit OMD_ to Manual Mode

To select the switch to operate by the automatic control unit OMD_ in Manual Mode:

- a Push the appropriate I, O or II key.
- b When pushing the I-key (see the Figure 6.2 /①, the I-switch will be in the ON position (the status and the line indication, see the Figure 6.2 /② and the II-switch will be in the OFF position. If the I-switch is already in the ON position, pushing the I-key does not have any influence.
- c When pushing the O-key, the I-switch will be in the OFF position. The II-switch remains in the OFF position.
- d When pushing the II-key, the II-switch will be in the ON position and the I-switch will be in the OFF position.
- e If you push the I-key while the II-switch is in the ON position, first the II-switch opens (OFF position) and then the I-switch closes its contacts (ON position).



When the automatic control unit OMD200 or OMD300 is in Manual Mode, the generator can't be operated.

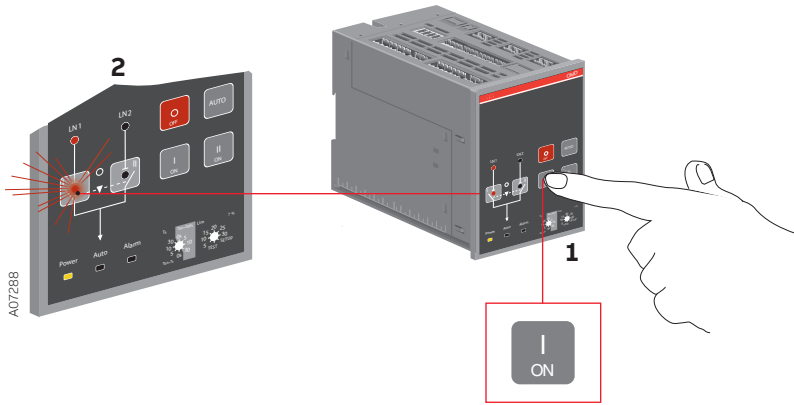

Figure 6.2 Selecting the switch to operate, the switch status and the chosen line indication with LEDs in OMD200 or OMD300



If a new command is given before the switch has reached the position of the previous command, the fuse (F1) of the motor operator may operate.

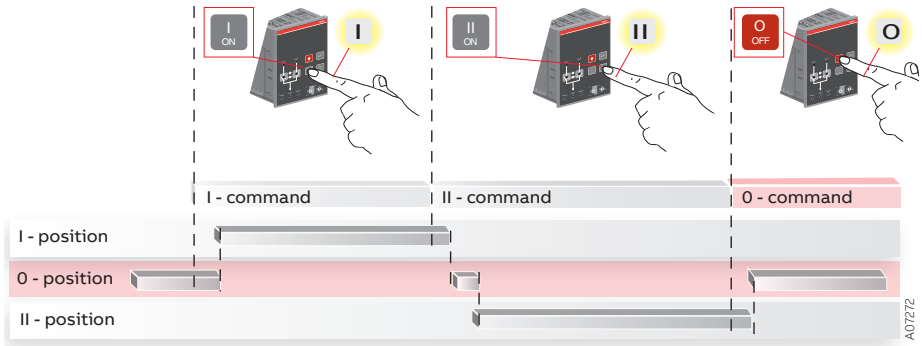

Figure 6.3 Manual Mode control

Pushing of the O-key (= O-command) will override the commands of the other keys. For example, if you simultaneously give an O-command and another command (I or II), the motorized change-over switch OTM_C is driven to the position O.

6.2 Automatic control unit in Automatic Mode

Selecting the automatic control unit OMD_ to the Automatic Mode:

- Make sure that power LED is ON. If Auto LED is ON/①, the automatic control unit is in Automatic Mode.
- If Auto LED is OFF /①, check that the Lim rotary switch is not in the TEST or SETUP position /②.
- Push the Auto key once /③. The Auto LED switches ON and the automatic control unit OMD_ is in Automatic Mode/④.

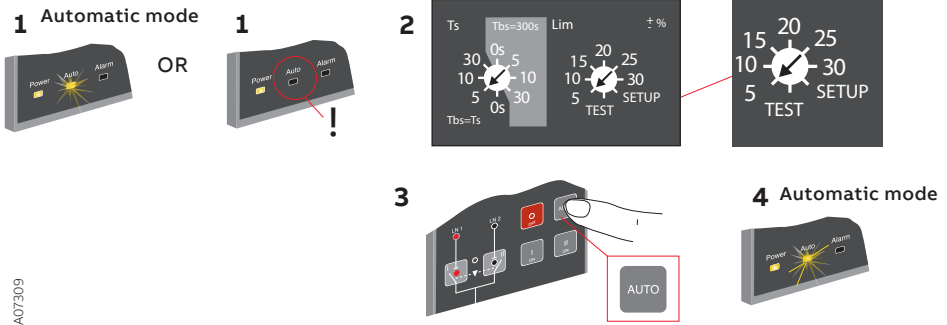

Figure 6.4 Selecting the automatic control unit OMD_ to Automatic

See the OMD200 and OMD300 Automatic Mode operation in Section 7.

6.3 Selection of delay time, voltage threshold and TEST function

The delay time and the voltage threshold are set by the rotary switches in automatic control units OMD200 and OMD300.

Ts / Tbs = Delay times for automatic switching

The delay time is the time before activating the switching sequence and the back switching sequence. User can choose two types of settings for delay times:

Choice 1: Darker side of the rotary switch

Available selections for the delay times are: 0, 5, 10 and 30 s. When this side is used the back switching delay Tbs is always same as switching delay Ts.

Choice 2: Lighter side of the rotary switch

Available selections for the delay times are: 0, 5, 10 and 30 s. When this side is used the back switching delay Tbs is always set to 300 s.

Lim = Voltage threshold with SETUP and TEST function

In OMD200 and OMD300 the available selections for voltage threshold are: ± 5 , ± 10 , ± 15 , ± 20 , ± 25 , ± 30 %, see the available settings / voltage in Figure 6.5. By setting the voltage threshold, the unbalance is also set to the same level.

When the user wants to enter to the SETUP mode, the automatic control unit has to be set to manual mode and Lim rotary switch has to be set to SETUP position. In SETUP mode it is possible to choose between three operating modes: standard switching mode, no priority mode or manual back switching mode. In the SETUP –mode user must also choose between automatic OTM_C_D, motorized OTM40...125_CMA_ or motorized OTM_160...2500_CM_ change-over switch. See Section 6.4.2 Choice of Operating mode in OMD200 and OMD300.

When the Lim rotary switch is set to the TEST position, the automatic control unit enters the test sequence. In test sequence it is possible to simulate switching and back switching sequences step by step by pushing the AUTO key.

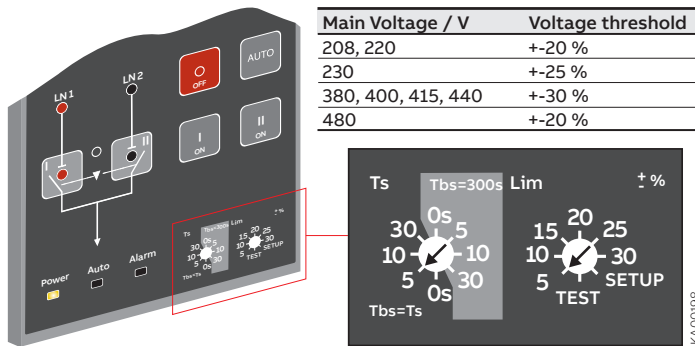

Figure 6.5 Selection of delay time and voltage threshold in OMD200 and OMD300

KA00198

Steps in the TEST sequence are:

- 1 Push AUTO; change-over switch to position II
- 2 Push AUTO; change-over switch to position I

After final step, the TEST sequence restarts. The user can stop the TEST sequence by turning the Lim rotary switch back to the voltage threshold wanted. After stopping the TEST sequence the device returns to the MANUAL mode. By pushing AUTO key once after stopping test sequence the device is set to the AUTO mode.

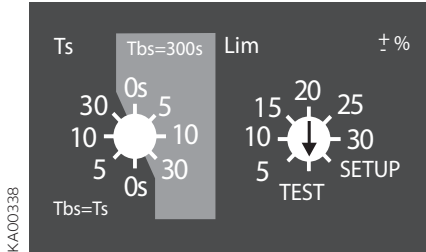

Figure 6.6 Lim rotary switch is set to the TEST function in OMD200 and OMD300

6.4 Operating modes

6.4.1 Operating modes in OMD200 and 300

6.4.1.1 Line 1 priority + automatic OTM_C_D or motorized OTM40...125_CMA_

This operating mode is used when user has automatic OTM_C_D change-over switch or motorized OTM40...125_CMA_ and line priority is Line 1 – Switch I.

6.4.1.2 No priority mode + automatic OTM_C_D or motorized OTM40...125_CMA_

This operating mode is used when user has automatic OTM_C_D change-over switch or motorized OTM40...125_CMA_ and neither of the lines has priority. No line priority means that after switching sequence the device remains on the Line 2 although the Line 1 starts to work properly. The back switching is performed only if the Line 2 fails.

6.4.1.3 Manual back switching mode + automatic OTM_C_D or motorized OTM40...125_CMA_

This operating mode is used when user has automatic OTM_C_D change-over switch or motorized OTM40...125_CMA_ and the automatic back switching sequence has to be inhibited for example while performing maintenance on the Line 1. If the Line 2 fails the switch is changed to the position O.

6.4.1.4 Line 1 priority + motorized OTM160...2500_CM_

This operating mode is used when user has motorized OTM160...2500_CM_ change-over switch and line priority is Line 1 – Switch I.

6.4.1.5 No priority mode + motorized OTM160...2500_CM_

This operating mode is used when user has motorized OTM160...2500_CM_ change-over switch and neither of the lines has priority. No line priority means that after switching sequence the device remains on the Line 2 although the Line 1 starts to work properly. The back switching is performed only if the Line 2 fails.

6.4.1.6 Manual back switching mode + motorized OTM160...2500_CM_

This operating mode is used when user has motorized OTM160...2500_CM_ change-over switch and the automatic back switching sequence has to be inhibited for example while performing maintenance on the Line 1. If the Line 2 fails the switch is changed to the position O.

6.4.2 Choice of Operating mode in OMD200 and OMD300

1. Set device to MANUAL mode according to the Figure 6.7.

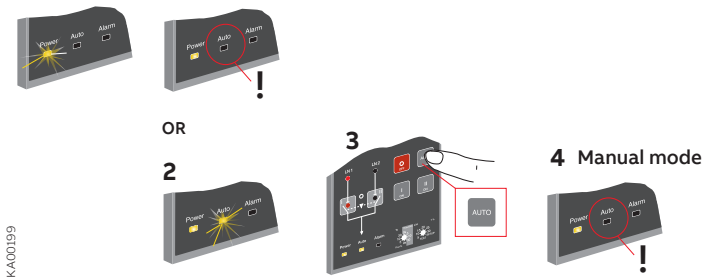

Figure 6.7 Selecting the automatic control units OMD200 and OMD300 to Manual Mode

2. Choose SETUP mode with Lim rotary switch according to the Figure 6.8.

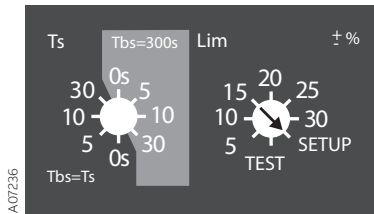

Figure 6.8 Setting of SETUP mode with Lim rotary switch in automatic control units OMD200 and OMD300

3. Press AUTO button to choose the mode. The Operation modes are indicated by LEDs according to the Table 6.1.

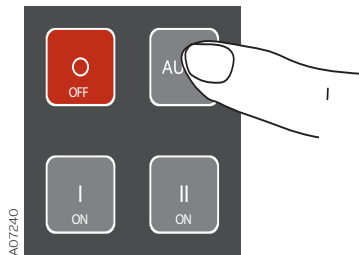

Figure 6.9 Choosing the Operation mode by pressing the AUTO button. See the Table 6.1 of LED indications for wanted Operation mode

5. Set device to AUTO mode according to the Figure 6.11

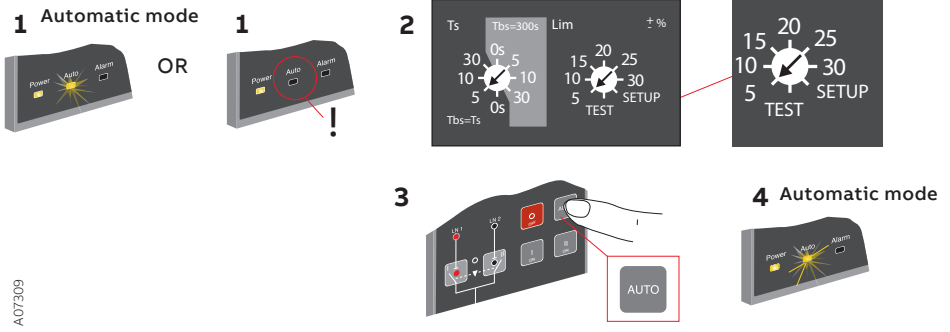

Figure 6.11 Selecting the automatic control units OMD200 and OMD300 to Automatic Mode

7 Using automatic control units OMD200 and OMD300

7.1 Interface

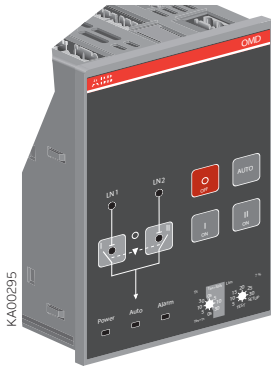

Figure 7.1 Interface of OMD200 and OMD300

7.1.1 Keypad

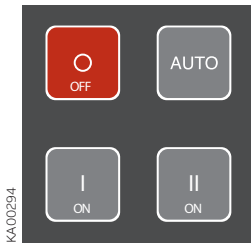

Figure 7.2 Keypad on OMD200 and OMD300

AUTO key

Selecting the automatic control unit OMD_ to the manual or automatic mode. An active alarm can reset by the AUTO key.

O key

Setting the motorized change-over switch OTM_C to the OFF position in manual and auto mode; both switches (I and II) are in the OFF position. After pressing the O-key the automatic control unit OMD_ is always in manual mode.

I key

Setting in manual mode the motorized change-over switch OTM_C to position I, when the I-switch will be in the ON position and the II-switch will be in the OFF position.

II key

Setting in manual mode the motorized change-over switch OTM_C to position II, when the II-switch will be in the ON position and the I-switch will be in the OFF position.

7.1.2 LEDs

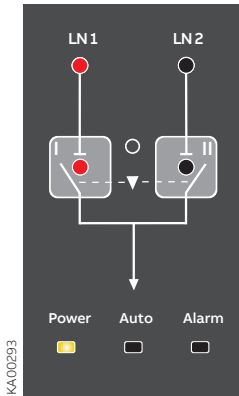

Figure 7.3 LEDs on OMD200 and OMD300

Line 1 status (LN1)

A red LN 1 LED signals the status of the line LN 1. Line status and indication is explained in the Table 7.1.

Line 2 status (LN2)

A red LN 2 LED signals the status of the line LN 2. Line status and indication is explained in the Table 7.1.

Line Status	LED indication
Voltage OK	ON
No voltage	OFF
Overvoltage	Fast blinking (5 Hz, 50 % ON / 50 % OFF)
Undervoltage	Blinking (1 Hz, 50 % ON / 50 % OFF)
Invalid frequency	Blinking (1 Hz, 90 % ON / 10 % OFF)
Unbalance	Blinking (1Hz, 10 % ON / 90 % OFF)

Table 7.1 Line status indication

Switch in position I (I)

A red I LED is ON, when the motorized change-over switch OTM_C is in the I position (the I-switch is ON and the II-switch is OFF), the LED is OFF otherwise. If transition from the O position to the I position fails, the I LED will blink.

Switch in position II (II)

A red II LED is ON, when the motorized change-over switch OTM_C is in the II position (the II-switch is ON and the I-switch is OFF), the LED is OFF otherwise. If transition from the O position to the II position fails, the II LED will blink.

Alarm

A red Alarm LED signals an external alarm. Alarm status is explained in the Table 7.2. An active alarm is set off by pushing the AUTO key.

Alarm Status	LED Indication
Handle attached	ON
Switching logic alarm	Blinking
No alarm	OFF

Table 7.2 Alarm status indication

NOTE: When the handle is removed, the automatic control unit will stay in Manual Mode and the Alarm LED will be OFF.



When the Alarm LED is ON or blinking, check the state of the motorized change-over switch and repair the possible fault situation. An active alarm is set off by pushing the AUTO key.

Auto

A green Auto LED signals the automatic or the manual mode. When the OMD200 or OMD300 is in automatic mode, the Auto LED is ON. When the device is in manual mode, the Auto LED is OFF. In the test sequence, the Auto LED is blinking.

Power

A green Power LED signals the power status. When power is ON, the Power LED is ON. The OMD200 or OMD300 will remain in standby state at least one minute after power failure. A blinking Power LED indicates standby mode.

7.2 Configuration

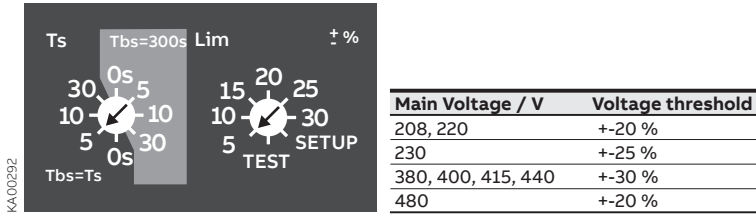

Figure 7.4 Selection of delay time and voltage threshold, the factory settings are shown in the figure, the available voltage threshold settings / voltage in the table

7.2.1 Rotary switches

TTs / Tbs = Delay times for automatic switching

The delay time is the time before activating the switching sequence and the back switching sequence. User can choose two types of settings for delay times:

Choice 1: Darker side of the rotary switch

Available selections for the delay times are: 0, 5, 10 and 30 s. When this side is used the back switching delay Tbs is always same as switching delay Ts.

Choice 2: Lighter side of the rotary switch

Available selections for the delay times are: 0, 5, 10 and 30 s. When this side is used the back switching delay Tbs is always set to 300s.

Lim = Voltage threshold with SETUP and TEST function

The available selections for voltage threshold in OMD200 and OMD300 are: ± 5 , ± 10 , ± 15 , ± 20 , ± 25 , ± 30 %, see the available settings / voltage in Figure 7.4. By setting the voltage threshold, the unbalance is also set to the same level.

When the user wants to enter to the SETUP mode, the automatic control unit has to be set to manual mode and Lim rotary switch has to be set to SETUP position. In SETUP mode it is possible to choose between three operating modes: standard switching mode, no priority mode or manual back switching mode. In the SETUP –mode user must also choose between automatic OTM_C_D, motorized OTM40...125_CMA_ or motorized OTM_160...2500_CM_ change-over switch. See Section 6.4.2 Choice of Operating mode in OMD200 and OMD300.

When the Lim rotary switch is set to the TEST position, the automatic control unit OMD200 or OMD300 enters the test sequence. In test sequence it is possible to simulate switching and back switching sequences step by step by pushing the AUTO key.

7.2.2 DIP switches / parameter settings

Automatic control units OMD200 and OMD300 have total of eight (8) adjustable parameters. The parameter settings are performed by the DIP switches and by the rotary switches.

- Un Rated voltage, setting by DIP switches S23-1...3
- fn Rated frequency, setting by DIP switch S23-4
- N Neutral in use, setting by DIP switch S24-1
- Ph Number of phases, setting by DIP switch S24-2
- Gen Generator in use, setting by DIP switch S24-3
- Gs Generator stop delay, setting by DIP switch S24-4
- Ts Switching delay, setting by Ts / Tbs rotary switch, see Section 7.2.1
- Tbs Back switching delay, setting by Ts / Tbs rotary switch, see Section 7.2.1
- THR Voltage threshold, setting by Lim rotary switch, see Section 7.2.1

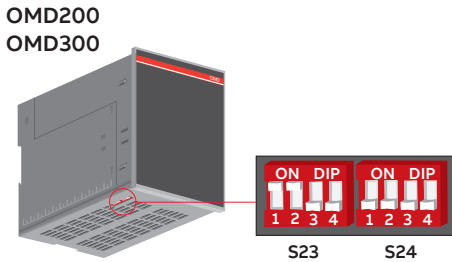

Figure 7.5 Places of the DIP switches











If single phase is used, the neutral should be connected.





Figure 7.6 DIP switches in OMD200 and OMD300, the positions are factory default settings

DIP switches S23**DIP switches S23-1...3 to set the rated voltage of monitored lines**



S23-1...3	Positions	Main/phase voltage (Un)	Positions	Main/phase fase voltage (Un)
	OFF, OFF, OFF	Un = 480/277 V		OFF, OFF, ON Un = 380/220 V
	ON, OFF, OFF	Un = 440/254 V		ON, OFF, ON Un = 230/130 V
	OFF, ON, OFF	Un = 415/240 V		OFF, ON, ON Un = 220/127 V
	ON, ON, OFF	Un = 400/230 V (default)		ON, ON, ON Un = 208/120 V

DIP-switch S23-4 to set rated frequency of the monitored lines



S23-4	Position	Rated frequency fn
	OFF	50Hz (default)
	ON	60 Hz

DIP switches S24

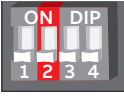

DIP-switch S24-1 to set neutral

S24-1	Position	Neutral N
	OFF	N used (default)
	ON	N not in use



DIP- switch S24-2 to set phase system

S24-2	Position	Generator
	OFF	three-phase (default)
	ON	single phase

DIP-switch S24-3 to set the generator in use

S24-3	Position	Generator
	OFF	not in use (default)
	ON	in use

DIP-switch S24-4 to set the generator stop delay Gs

S24-4	Position	Generator stop delay Gs
	OFF	Gs = Switching delay Ts (default)
	ON	Gs = 300 seconds

NOTE: See Section 10.2.1 Delay time (Ts)

7.3 TEST sequence

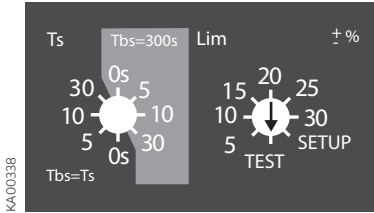

Figure 7.7 Lim -rotary switch is set to the TEST position

When the Lim rotary switch is set to the TEST position, automatic control unit OMD200 or OMD300 enters the test sequence. While entering the test sequence OMD200 or OMD300 blinks all LEDs twice to give the information that the LEDs are functioning.

In the TEST position it is possible to simulate switching and back switching sequences step-by-step by pressing the AUTO key. The user can interrupt the simulation at any place and return to normal use of the device. More information, see Section 6.3.

NOTE: In the TEST sequence the power circuit is switched on!

NOTE: After testing the user must ensure that the device is not left in the TEST position by accident.

NOTE: TEST sequence is interrupted for example because of power failure, it is continued from that same situation where it was when interrupted.

8 Technical data of the automatic control units OMD200 / OMD300

Operating voltage	
Main voltage ^{a)}	208Vac - 480 Vac ($\pm 20\%$) + N
Phase voltage ^{a)}	120Vac - 277 Vac ($\pm 20\%$)
Frequency	50 Hz, 60 Hz ($\pm 10\%$)
Voltage and frequency sensing precision	
Voltage	5 %
Frequency	1 %
Relay utilization category	
X21, X22	12 A, AC1, 250 V / 12 A, DC1, 24 V
X23	8 A, AC1, 250 V / 8 A, DC1, 24 V
X24	8 A, AC1, 250 V / 8 A, DC1, 24 V
X26, X27, X28	10 A, AC1, 250 V / 5 A, DC1, 24 V
Over voltage category	III, U_{imp} 6 kV
IP rating	IP40 for the front panel
Temperature area	-20 to +60 °C
Transportation and storage temperature	-25 to +80 °C
Humidity	
with condensation	5 % - 98 %
without condensation	5 % - 90 %

a) OMD300: Rated voltage should be 380...415/220...240 Vac +/-20% in order that the dual power source provides voltage supply.

Table 8.1 **Technical data of OMD200 and OMD300**

9 Troubleshooting

9.1 OMD200, OMD300

State	Action
Switching from position I to position O fails. After 3 seconds the Alarm LED blinks and the I LED is ON.	<p>The alarm can be reset by pressing the AUTO key.</p> <p>If the alarm does not disappear, please check that the handle has been removed from the change-over switch and the change-over switch is not padlocked from the front panel.</p> <p>If the alarm can be reset but it activates again after trying to operate the switch, please check that the Motor/Manual selector of the change-over switch (only with motorized change-over switches OTM160...2500_CM) is in Motor (M) position and check the fuse (F1) of the motor operator</p>
Switching from position II to position O fails. After 3 seconds the Alarm LED is blinking and the II LED is ON.	<p>The alarm can be reset by pressing the AUTO key.</p> <p>If the alarm does not disappear, please check that the handle has been removed from the change-over switch and the change-over switch is not padlocked from the front panel.</p> <p>If the alarm can be reset but it activates again after trying to operate the switch, please check that the Motor/Manual selector of the change-over switch (only with motorized change-over switches OTM160...2500_CM) is in Motor (M) position and check the fuse (F1) of the motor operator.</p>
Switching from position O to position I fails. After 3 seconds the Alarm LED and the I LED are blinking.	<p>The alarm can be reset by pressing the AUTO key.</p> <p>If the alarm does not disappear, please check that the handle has been removed from the change-over switch and the change-over switch is not padlocked from the front panel.</p> <p>If the alarm can be reset but it activates again after trying to operate the switch, please check that the Motor/Manual selector of the change-over switch (only with motorized change-over switches OTM160...2500_CM) is in Motor (M) position and check the fuse (F1) of the motor operator</p>
Switching from position O to position II fails. After 3 seconds the Alarm LED and the II LED are blinking.	<p>The alarm can be reset by pressing the AUTO key.</p> <p>If the alarm does not disappear, please check that the handle has been removed from the change-over switch and the change-over switch is not padlocked from the front panel.</p> <p>If the alarm can be reset but it activates again after trying to operate the switch, please check that the Motor/Manual selector of the change-over switch (only with motorized change-over switches OTM160...2500_CM) is in Motor (M) position and check the fuse (F1) of the motor operator.</p>

Table 9.1 Fault situations in OMD200 or OMD300

9.2 Explanations of internal faults OMD200, OMD300

When digital Input 1 and 2 are both active, logic is locked and the Alarm LED is ON.

When digital Input 3 is active, logic is locked and the Alarm LED is ON.

9.3 Change-over switch does not respond

During the switching sequence, the OMD_ operates the change-over switch (Switch I) first to the position O from position I. If this transition is not completed in three seconds, the Open 1 Failure is activated. If switching to the position O is completed, but the transition (Switch II) from O to II fails, the Close 2 Failure is activated. These alarms will lock the switching logic and can only be reset by pushing the AUTO key.

During the back switching sequence, similar transitions will be performed from II to O and from O to I, possibly activating Open 2 Failure or Close 1 Failure.

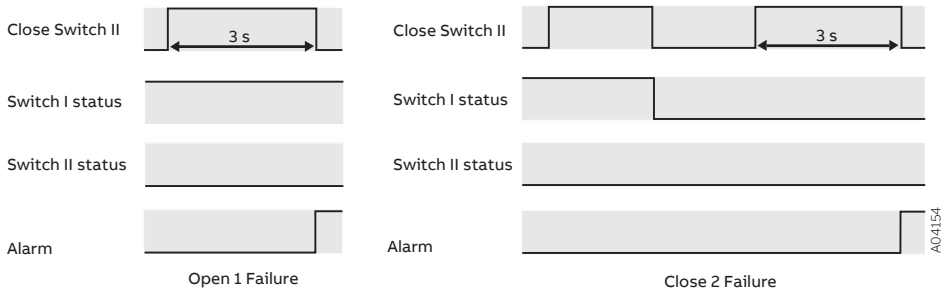

Figure 9.1 Unsuccessful switching sequence

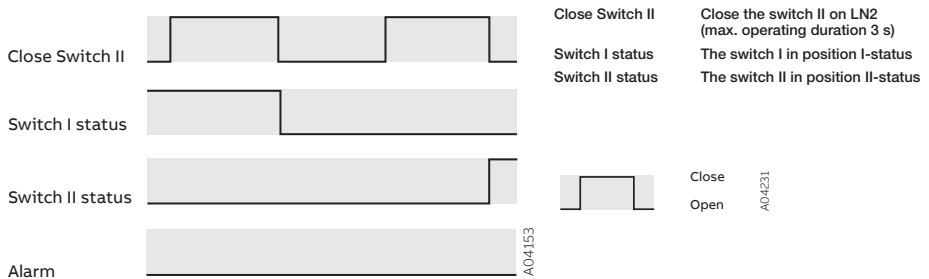

Figure 9.2 Successful switching sequence

9.4 Missing of both lines

The missing of both lines is indicated by a blinking Power LED. In this case, the OMD_ will be in a power saving state. If both lines are missing more than one minute, the OMD_ will shut down.

10 Accessories

10.1 Fastener

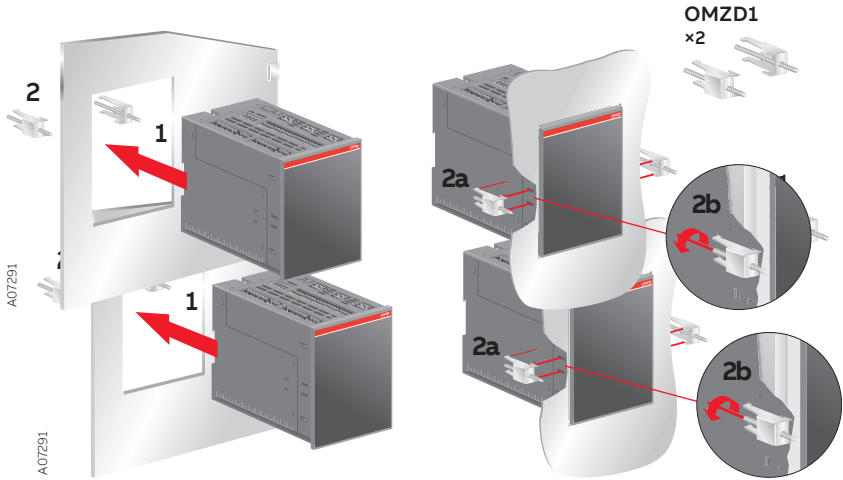

Figure 10.1 Fastener OMZD1, used when the automatic control unit OMD_ is mounted on the door

10.2 Cover plate

OMZC2
IP54

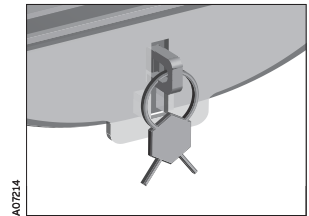
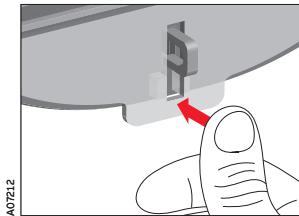
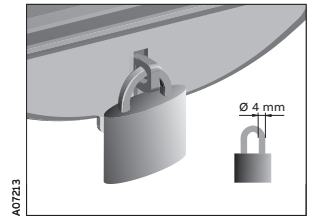
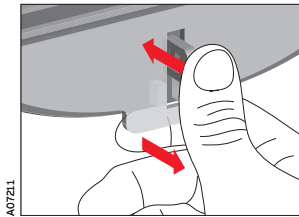
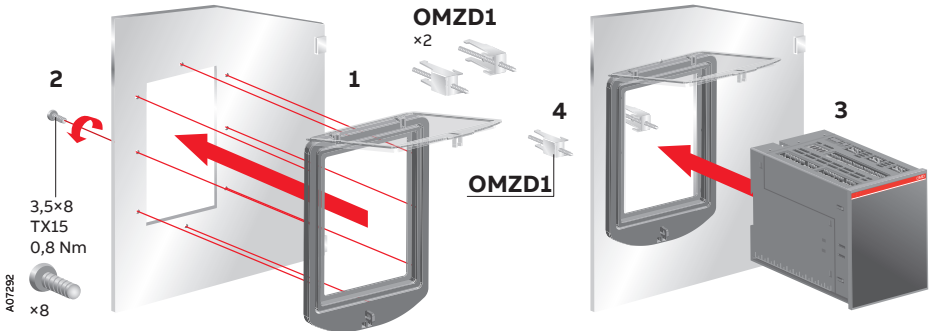

Figure 10.2 Door drilling and mounting of the cover plate OMZC2, when the automatic control unit MD200 or OMD300 is mounted on the door

OMZC2
IP54

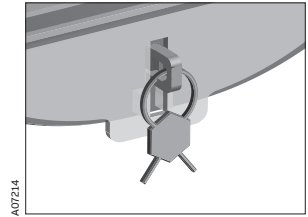
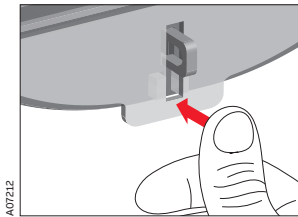
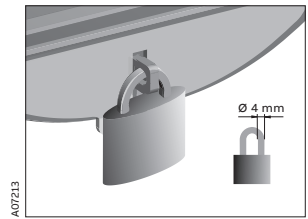
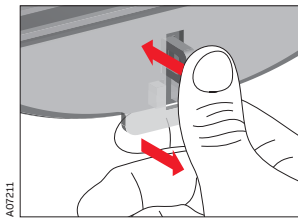
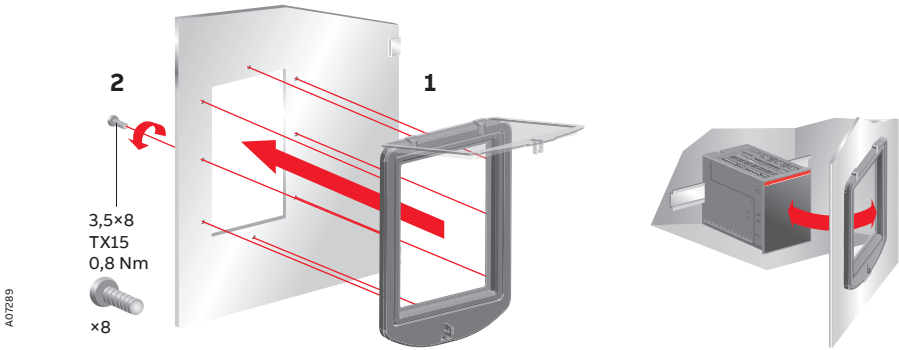
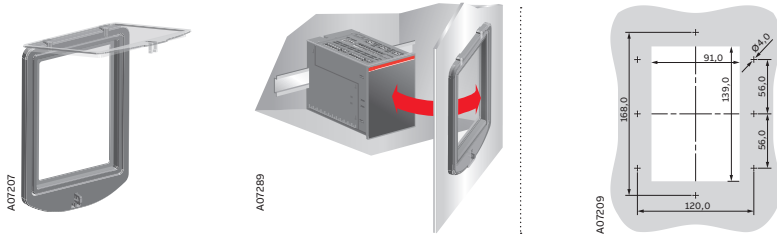

Figure 10.3 Door drilling and mounting of the cover plate OMZC2, when the automatic control unit OMD200 or OMD300 is mounted on the DIN-rail



BG	Внимание! Опасно напряжение! Да се монтира само от лице с електротехническа квалификация.
CN	警告！电压危险！只能由专业电工进行安装。
CZ	Varování! Nebezpečné napětí! Montáž smí provádět výhradně elektrotechnik!
DA	Advarsel! Farlig elektrisk spænding! Installation må kun foretages af personer med elektroteknisk ekspertise.
DE	Warnung! Gefährliche Spannung! Installation nur durch elektrotechnische Fachkraft.
EL	Προειδοποίηση! Υψηλή τάση! Η εγκατάσταση πρέπει να γίνεται μόνο από εξειδικευμένους ηλεκτροτεχνικούς.
EN	Warning! Hazardous voltage! Installation by person with electrotechnical expertise only.
ES	¡Advertencia! ¡Tensión peligrosa! La instalación deberá ser realizada únicamente por electricistas especializados.
ET	Hoiatus! Ohtlik pinge. Paigaldada võib ainult elektrotehnika-alane ekspert.
FI	Varoitus! Vaarallinen jännite! Asennuksen voi tehdä vain sähköalan ammattihenkilö.
FR	Avertissement! Tension électrique dangereuse! Installation uniquement par des personnes qualifiées en électrotechnique.
HR	Upozoreње! Opasan napon! Postavljati smije samo elektrotehnički stručnjak.
HU	Figyelmeztetés! Veszélyes feszültség! Csak elektrotechnikai tapasztalattal rendelkező szakember helyezheti üzembe.
IE	Rabhadh! Voltas guaiseach! Ba chóir do dhuine ag a bhfuil saeolas leictreicniúil, agus an té sin amháin, é seo a shuiteáil.
IT	Avvertenza! Tensione pericolosa! Fare installare solo da un elettricista qualificato.
LT	Dėmesio! Pavojinga įtampa! Dirbti leidžiama tik elektrotechniko patirties turintiems asmenims.
LV	Uzmanību! Bīstami - elektrība! Montāžas darbus drīkst veikt tikai personas, kurām ir atbilstoša elektrotehniskās zināšanas.
MT	Twissija! Vultaġġ perikoluż! Għandu jiġi installat biss minn persuna b'kompetenza elettroteknika.
NL	Waarschuwing! Gevaarlijke spanning! Mag alleen geïnstalleerd worden door een deskundige elektrotechnicus.
NO	Advarsel! Farlig spenning! Montering skal kun utføres av kvalifiserte personer med elektrokompetanse.
PL	Ostrzeżenie! Niebezpieczne napięcie! Instalacji może dokonać wyłącznie osoba z fachową wiedzą w dziedzinie elektrotechniki.
PT	Aviso! Tensão perigosa! A instalação só deve ser realizada por um electricista especializado.
RO	Avvertizare! Tensiune periculoasă! Instalarea trebuie efectuată numai de către o persoană cu experiență în electrotehnică.
RU	Осторожно! Опасное напряжение! Монтаж должен выполняться только специалистом-электриком.
SE	Varning! Farlig spänning! Installation får endast utföras av en elektriker.
SK	Varovanie! Nebezpečné napätie! Montáž môže vykonávať iba skúsený elektrotechnik.
SL	Opozorilo! Nevarna napetost! Vgradnjo lahko opravi le oseba z elektrotehničnim strokovnim znanjem.



Contact us

ABB Oy

Muottitie 2A 65320

Vaasa, Finland

abb.com/lowvoltage