

ESDEC

INNOVATIVE MOUNTING SYSTEMS

MANUAL EN MOUNTING SYSTEM CORRUGATED ROOF LANDSCAPE

CLICKFIT EVO

CORRUGATED ROOF

www.esdec.com

DISCLAIMER

This installation manual should be kept for future use!

For more information on the warranty period and terms, we recommend contacting your supplier. We would furthermore like to refer to our general terms and conditions, which can be found on the website www.esdec.com. The manufacturer cannot be held liable for damage or injury resulting from a failure after not carefully following the instructions in this manual, or not taking the necessary care during transport, installation and use of the ClickFit mounting system.

GENERAL INSTALLATION CONDITIONS

General

Failure to comply to the instructions stipulated in this manual may result in a lapse of all warranty and product liability claims.

The information, notes and advice in this document are binding and should be monitored to make sure they are complete and up to date. Esdec reserves the right to make adjustments to this document without prior notice.

Roof stability and condition

The roof should be in good condition and should be sturdy enough to support the weight of the solar panels including any accompanying materials, wind, and snow load. Check the stability of the roof and adjust the roof construction if necessary. In case of doubt, please reach out for professional advice. Make sure the roof load reserve is not exceeded anywhere.

Safety warnings

- Before you start the installation, you should know the material of the corrugated sheets.
- This product is not suitable for sheets containing asbestos.
- The installation of the ClickFit mounting system should always be performed by qualified technical staff (at least 2 competent persons).
- The addition or omission of system parts can negatively impact functionality and is strongly discouraged!
- Make sure the roof is clean, dry, even and free of algae etc. before placing the solar panels.
- Avoid installation under strong winds and on a wet, slippery roof surface.
- On pitched roofs, always use fall protection and, if necessary, safety nets, edge protection and gangways.
- Never walk on the system or on the solar panels.
- Wear shoes with reinforced toecaps and sturdy anti-slip soles.
- Always use the appropriate protective clothing when performing activities.
- Always use a lifting aid/lifting installation to move the materials (solar panels etc.).
- Always place ladders on sturdy, stable surfaces.
- Always place the ladder at a 75° -degree angle and make sure it extends about 1 metre above the edge of the roof.
- If possible, secure the ladder at the top with a rope or lashing strap.

ClickFit range of application

- Panel dimensions: maximum solar panel size of 3.92 m².
- The universal module clamp is suitable for solar panels with a frame thickness between 30 - 50 mm and a frame width of at least 12 mm, where a sufficient clamping force can be achieved. Thanks to its smart design, the ClickFit Evo universal clamp can be used as a middle clamp and as an end clamp (in combination with the end cap). Check whether the chosen solar panel can withstand the loads and clamping force, in the documentation of the solar panel supplier.
- The minimum dilatation distance between the segments is 125 mm.
- Maximum roof height: dependent on Eurocode guidelines and national additions. Use the calculator to calculate the possibilities for your project.
- Roof surface type: Corrugated sheets.
- Roof pitch: Between 2 and 60 degrees. Improper installation of solar panels at a low inclination angle can reduce the self-cleaning capacity of the system; carefully follow the panel manufacturer's instructions.
- Use the calculator to ensure you select the right mounting system for the terrain category, snow load and wind zone applicable to your project.

Edge zone

The distance between the solar panels and the ridge and gutter should be at least 30 cm due to wind load. The distance between the solar panels and the edge of the roof should also be at least 30 cm. Solar panels can neither fully nor partially be placed in this zone.

As a result of our continued aim for improvement, certain details of the product may deviate from what is described in this manual. Because of this, these instructions only serve as a guideline for the installation of the product described in this manual.

While this manual was compiled with the utmost care, the manufacturer cannot be held liable for any errors in this manual or the consequences thereof. Furthermore, all rights are reserved, and no part of this manual may be reproduced in any way, shape or form.

Standards, regulations and legislation

During the installation of the mounting system, it is important to adhere to the mounting manual and the accompanying standards to prevent accidents. Pay special attention to the following norms, regulations and legislation (among others):

- The Building Regulations 2010 (latest version)
- Health and Safety at Work etc Act 1974
- Health and Safety in Roof work - HSE
- Eurocodes 0 (EN 1990 - Structural Design)
- Eurocodes 1 (EN 1991 - Influences on structures)
- HD-IEC 60363 series - Electrical installations for low voltage
- EN-IEC 62305-2 - Protection lightning - Risk Management
- MIS 3002 - The solar PV standard
- MCS012 - Product Certification Scheme Requirements: Pitched Roof Installation Kits



Removal and dismantling

Dispose of the product in accordance with local laws and regulations.

Earthing and bonding

Our ClickFit EVO systems are VDE certified for corrosion and bonding. According to the electrical standard HD-IEC 60364 – chapter 712, functional bonding for inverter's isolation check is necessary.

In the Esdec ClickFit EVO Series functional bonding is achieved through the EVO universal module clamp for the module frames and EVO rails. The final functional bonding connection is made by proper mounting of a separate bonding cable onto the EVO rail and an adequate bonding connection with the inverter or earthing contact.

For detailed instructions on grounding and bonding, consult the electrical standard HD-IEC 60364 and any local regulations. Please, follow the instructions of the inverter's manual. This operation needs to be done by a certified electrician.

Warranty

Warranty according to the terms and conditions of Esdec. These can be found on the website www.esdec.com

Maintenance

The ClickFit EVO system is designed to be virtually maintenance-free. A few points need to be checked to ensure structural integrity and the function of the system.

The following points need to be checked on a yearly basis and after each storm with wind speeds >9Bft.:

- The reliability of all bolts, nuts, screw and clamp connections.
- **Action:** Tighten all bolts, nuts, screws, and clamps where necessary according to the installation manual and report it to Esdec BV including photographs.
- Overall visual control of ClickFit EVO system (corrosion of components, etc).
- **Action:** Report it to Esdec BV including photographs.

Liability

The manufacturer shall not be held liable for any damage or injury caused by a failure to (strictly) adhere to the safety regulations and instructions in this manual or due to carelessness during the installation of the product and any accessories described in this document.

- printing errors reserved

1 PARTS OVERVIEW

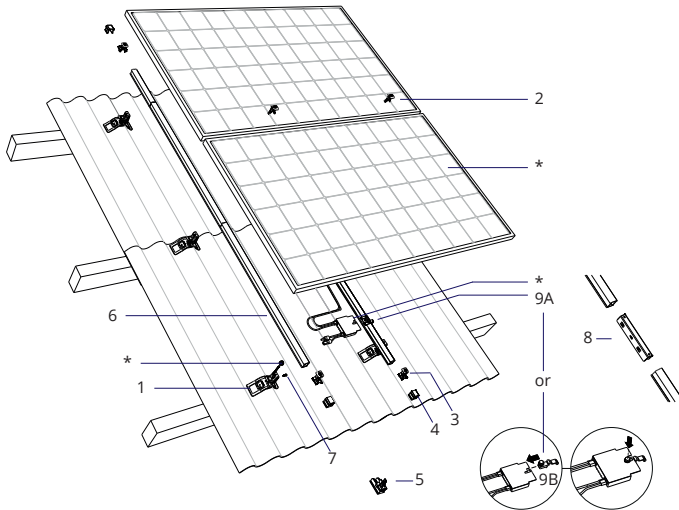

ROOF SPECIFICATIONS

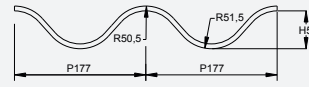

P (pitch)	177mm
R1 (outer radius)	50,5mm
R2 (outer radius)	51,5mm
H	51mm

Corrugated sheets of the wave type 177/51 that comply with the applicable requirements as stated in NEN EN 494 will be supported by the mounting bracket.

* These parts are not delivered by Esdec.

ROOF CONNECTOR



1. ClickFit EVO Corrugated Sheet Mounting Bracket 1008090

MOUNTING RAIL



6. ClickFit EVO Mounting Rail
Mounting Rail 100800_
Mounting Rail 10081_

MODULE CLAMP & END CAPS



2. ClickFit EVO Module Clamp Universal Grey 1008020

2B. ClickFit EVO Module Clamp Universal Black 1008020-B



3. ClickFit EVO End Clamp Support Grey 1008065

3B. ClickFit EVO End Clamp Support Black 1008065-B



4. ClickFit EVO End Cap Without End Clamp Support Grey 1008066

4B. ClickFit EVO End Cap Without End Clamp Support Black 1008066-B



5. ClickFit EVO Mounting Rail End Cap Grey (optional) 1008060

5B. ClickFit EVO Mounting Rail End Cap Black (optional) 1008060-B

MOUNTING MATERIALS



7. Self-drilling Screw 6.3x42mm SW10/T30 1003016

ACCESSOIRES



8. ClickFit EVO Mounting Rail Connector Piece 1008061



9A. ClickFit EVO MLPE Clip Light Weight 1008067



9B. ClickFit EVO MLPE Clip Heavy Weight 1008068

TOOLS & AIDS



2 INSTALLATION PREPARATIONS

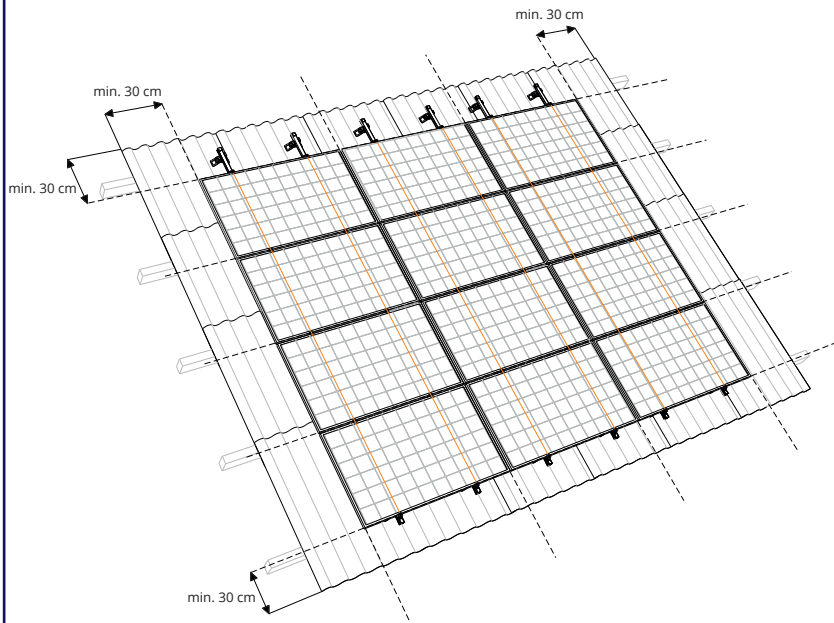
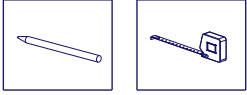

1 TAKE INTO ACCOUNT THE (LOCAL) FIRE REGULATIONS FOR PHOTOVOLTAIC INSTALLATIONS.

- ⚠ Note:** Take into account the (local) fire regulations for photovoltaic installations. To reduce the risk of fire spread, the fire compartments of the object must be respected. The PV system must not be installed over fire partitions and a minimum distance of 30 cm must be maintained. It is also wise to keep space in relation to skylights, orbs, corners and possible fire hazards.

2 DETERMINE THE ROOF CONDITION



- ⚠ Note:** Make sure your roof is in good condition!

3 POSITION THE SOLAR PANELS

- ⚠ Note:** Place the solar panels on a roof surface without shade. Shade negatively affects the solar panel yield.

4 MEASURING AND MARKING

1. Calculate the space you need based on your panel dimensions.
2. Maintain 30 cm of space around the panel field (30 cm from the ridge and gutter due to wind load).
3. Mark the intended location of the panel field, the rails and brackets.

- ⚠ Note:** For many cases it is not allowed to mount on the ridge components. Read your corrugated roof supplier's instruction manual.

3 ASSEMBLING THE RAILS (OPTIONAL)

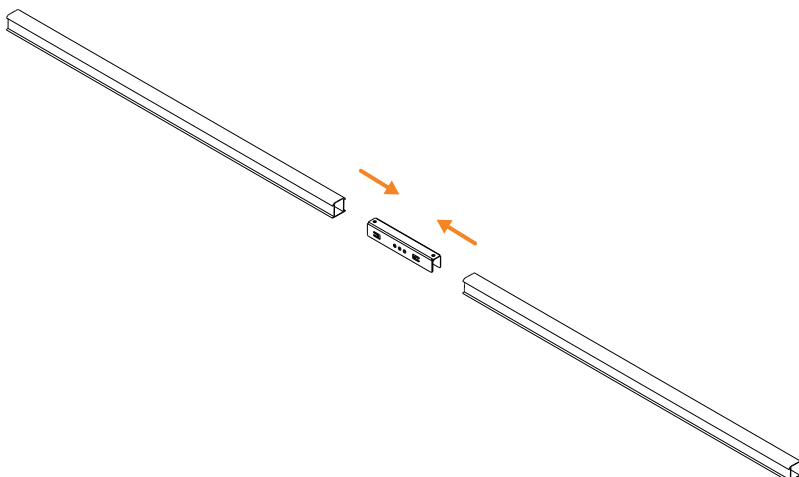
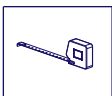

1 DETERMINE THE TOTAL RAIL LENGTH & MOUNT THE RAILS USING CONNECTOR PIECES IF NECESSARY

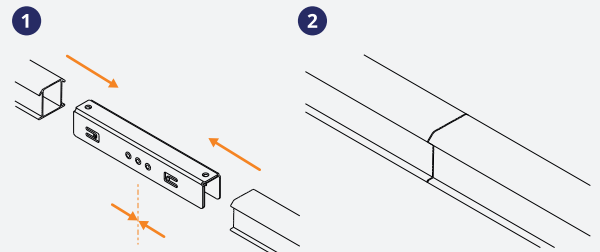

- ⚠ Note:** Dilatation (an interruption) is required for rail lengths larger than 15 metres.

2 CONNECT THE RAILS UP TO THE TOTAL REQUIRED RAIL LENGTH*

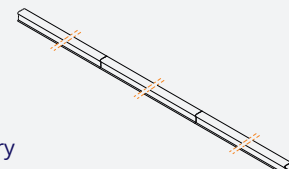

*If necessary

4 INSTALLING THE MOUNTING BRACKETS

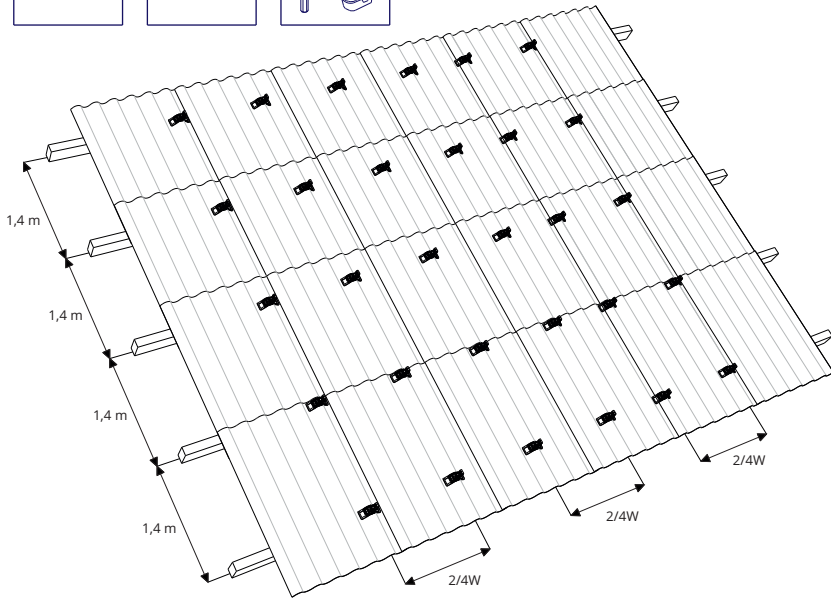
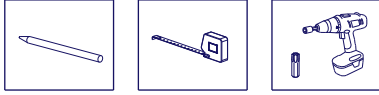

1 PLACE THE MOUNTING BRACKETS ON THE PURLINS

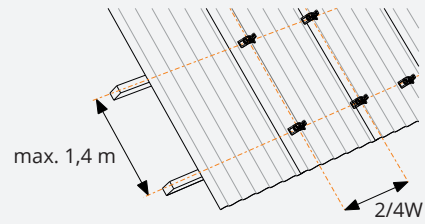

Only use the (existing) roof screws in the positions indicated by the corrugated sheet supplier. Screws should not be used in different positions. Exclusive mounting on corrugated sheet's rise and right above the purlin.

NEW CONSTRUCTION

⚠ Note:

Width between brackets:
 $\pm 2/4W$ of the solar panel
 Length between brackets:
 purlin distance (1.4 metres maximum)

EXISTING CONSTRUCTION

⚠ Note:

Place the brackets in the position of the current roof screws. Check instruction manual manufacturer corrugated roof.

2 PLACE THE MOUNTING BRACKET

NEW CONSTRUCTION

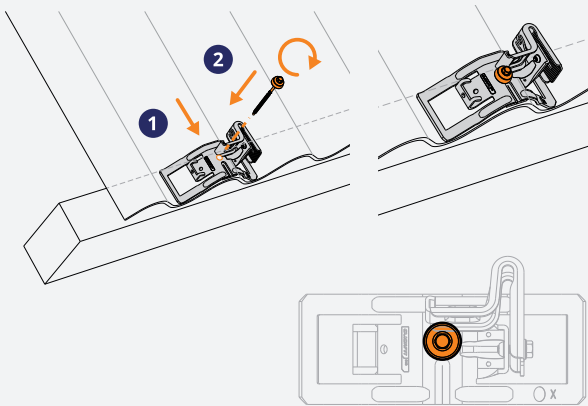

1. Mount the mounting bracket on the purlin.
 2. Place the roof screw through the hole.
- CAUTION: DO NOT mount on first and last rise of corrugated sheet. Read roof supplier's instruction manual!**

EXISTING CONSTRUCTION

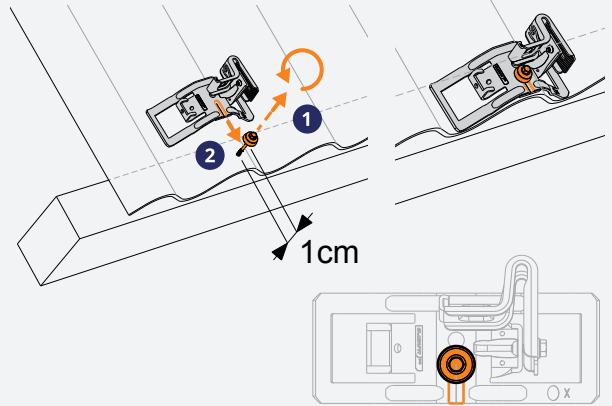

1. Loosen the roof screw 1 cm, but do not remove it from the purlin.
2. Slide the mounting bracket over the roof screw from above, until it reaches the end of the slotted hole.

3 SCREW THE MOUNTING BRACKET IN PLACE

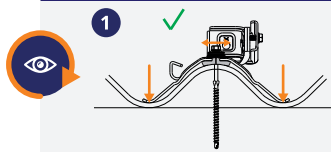

1. The feet of the mounting brackets should rest in the troughs.

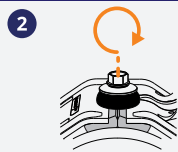

2. Tighten the screw until the EPDM seal of the bracket is in contact with the sealing rubber of the screw.

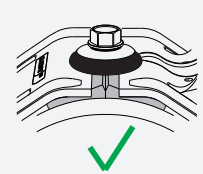
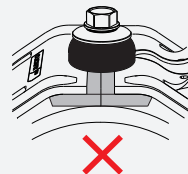

4 TWIST THE RAIL BRACKET 90 DEGREES

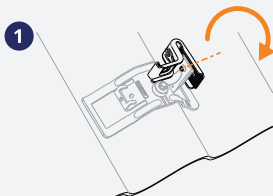

1. Turn the rail bracket by 90 degrees.

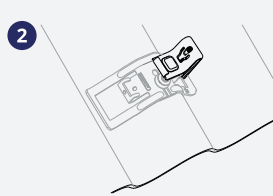

2. Do not screw the rail bracket in place yet.

5 MOUNTING THE RAILS

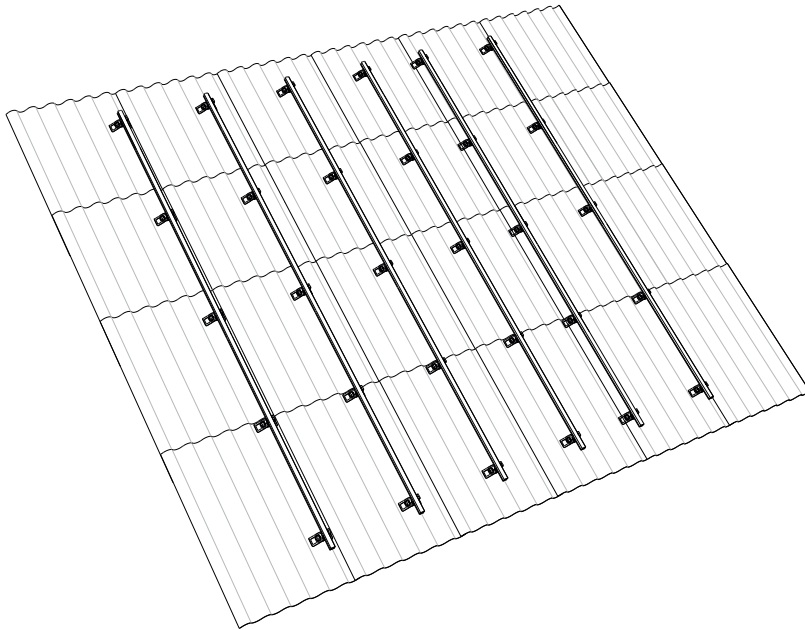
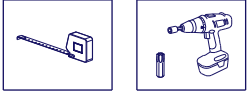

1 PLACE THE RAIL ON THE MOUNTING BRACKET AND CLICK IT IN PLACE



1. Make sure the rail exceeds 80-350 mm beyond the last mounting bracket.
2. First place the rail over the entire length of the brackets before clicking it in place.

2 TIGHTEN THE SCREW OF THE MOUNTING BRACKET AT THE DESIRED HEIGHT

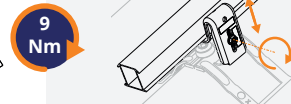

3 INSERT THE LOCKING SCREW INTO THE SIDE OF THE RAIL BRACKET

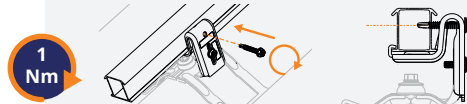

- Note:** Place a locking screw every other three brackets (above each other) and always start at the bottom.
- Note:** A locking screw has to be inserted on the edges of the panel field, on each mounting bracket with the exception of the ridge. See construction plan.

6 MOUNTING CLICKFIT EVO MLPE LIGHT / HEAVY WEIGHT CLIPS (OPTIONAL)

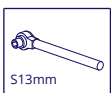
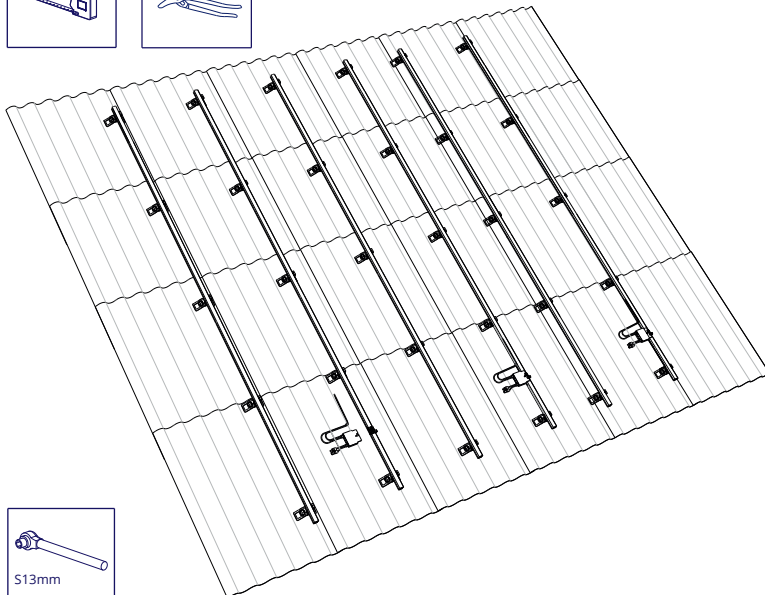

4 MOUNTING CLICKFIT EVO MLPE CLIP HEAVY WEIGHT (OPTIONAL FOR MLPE DEVICES EXCEEDING 2 KG)

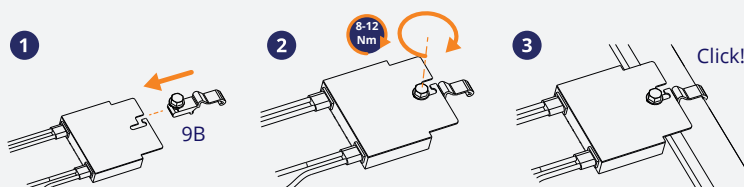

1 MOUNTING CLICKFIT EVO MLPE CLIP LIGHT WEIGHT

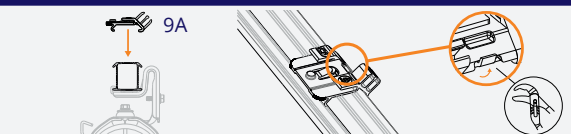

- Note:** Place the clips about 1 metre apart and below the centre of the panel.

Bend the edge of the mounting rail with water pump pliers to secure the clip.

2 GUIDE THE CABLES THROUGH THE BRACKET AND CLIP

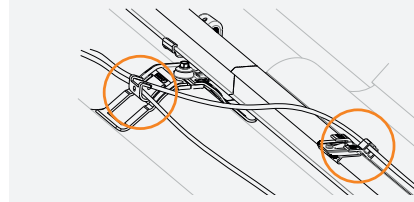

3 CLICK THE MLPE DEVICE ON THE CLIP AND GUIDE THE CABLES THROUGH THE CLIP (OPTIONAL)

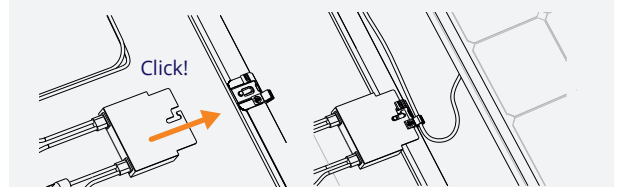

7 MOUNTING THE FIRST SOLAR PANEL

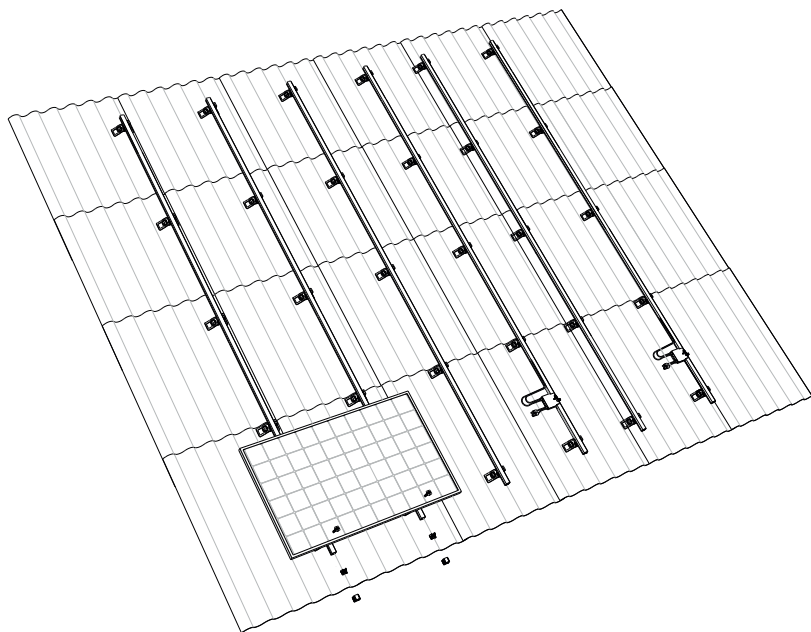
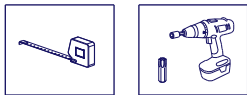

1 MOUNT THE FIRST SOLAR PANEL ONTO THE RAILS

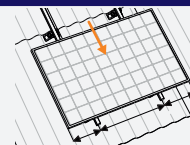

⚠ Note: Click the cables into the cable clip and slide the panel to the bottom of the rail.

2 PLACE THE MODULE CLAMP AND SLIDE THE END CLAMP SUPPORT AND END CAP ONTO THE RAIL

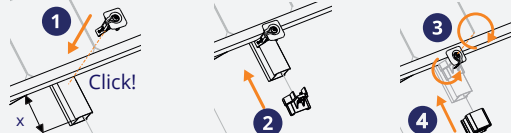

1. Place the module clamp onto the rail.

⚠ Note: The rail has to exceed at least 80 mm.

2. Slide the end clamp support onto the rail.

3. Turn the lip of the module clamp and screw the module clamp in place.

4. Place the end cap.

4,5 Nm

It is also possible to use the entire end cap. Keep 20-35 mm rail length available for this.



8 MOUNTING OTHER SOLAR PANELS

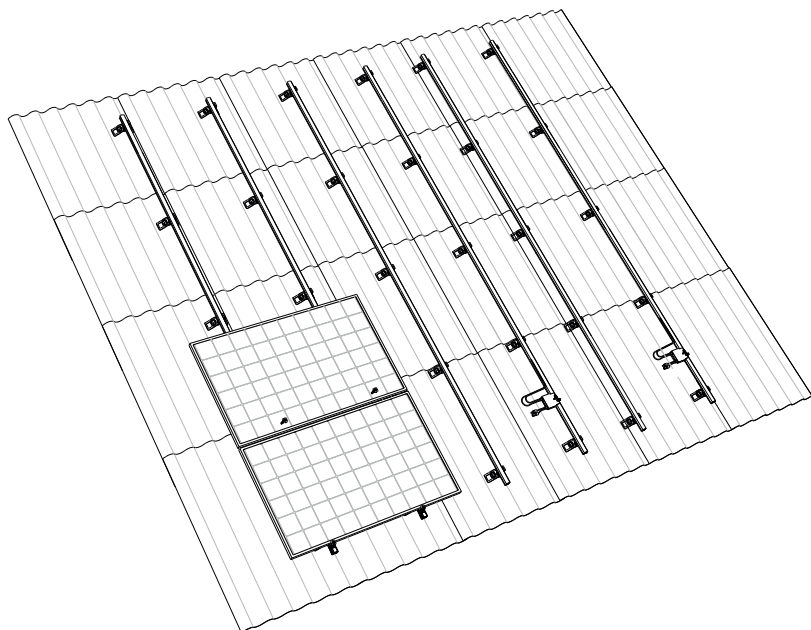

1 PLACE THE MODULE CLAMP ONTO THE RAILS AGAINST THE FIRST SOLAR PANEL



2 PLACE THE SECOND SOLAR PANEL ONTO THE RAILS AND SLIDE IT AGAINST THE FIRST ONE

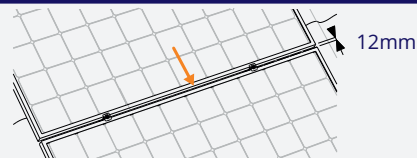

⚠ Note: Make sure the gap is 12 mm and the solar panels are aligned before you tighten the screw.

3 PLACE THE MODULE CLAMP AND SCREW IT IN PLACE



4,5 Nm

9 FINAL ASSEMBLY FIRST ROW AND MULTIPLE ADJACENT ROWS

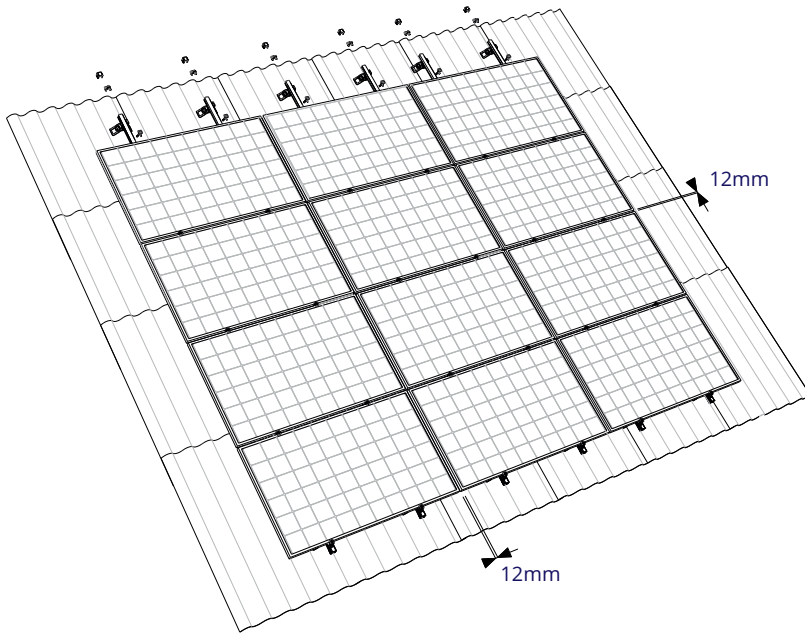

1 MOUNT THE TOP SOLAR PANEL ONTO THE RAILS

2 PLACE THE MODULE CLAMP AND SLIDE THE END CLAMP SUPPORT AND END CAP ONTO THE RAIL

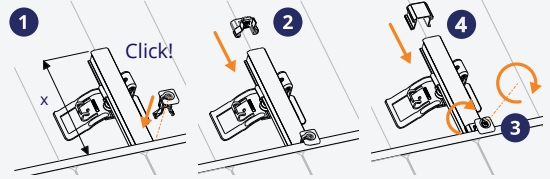

1. Secure the module clamp to the rail.

⚠ Note: The rail should exceed at least 80 mm.

2. Slide the end clamp support onto the rail.

3. Turn the lip of the module clamp and screw the module clamp in place.

4. Place the end cap.

4,5 Nm

It is also possible to use the entire end cap. Keep 20-35 mm rail length available for this.

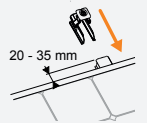

3 PLACE THE REST OF THE SOLAR PANELS AGAINST THE ROW TO FINISH THE FIELD

Repeat steps 7 - 9 to finish the rows.

⚠ Note: Care must also be taken here to ensure that a gap of 12mm is maintained.

QUICK
RELIABLE
INNOVATIVE

16-09-2024

MAKE THE CLICK WITH ESDEC

Esdec has developed, produced and supplied professional mounting systems for solar panels on roofs since 2004. ClickFit and FlatFix are inspired by installers who regularly place solar panels.

Easy, quick and reliable installation with innovative, high-grade and sustainable mounting systems; that is what Esdec offers.

Esdec

Londenstraat 16
7418 EE Deventer
The Netherlands

+31 850 702 000
info@esdec.com

www.esdec.com