











META Wandventil Kaltwasser ohne Ablaufgarnitur - Champagne gebürstet (22kt Gold)

META

30 010 662



- Ausladung 126 mm
- starrer Auslauf
- runder luftangereicherter Strahl
- Bohrungsdurchmesser 35 mm
- Rosette Ø 60 mm
- Durchfluss max. 5,7 l/min
- bleifrei
- Dieses Produkt leistet einen Beitrag zur Erfüllung der Vorgaben von nachhaltigen Gebäudezertifizierungen, z.B. LEED®, BREEAM®, DGNB

	Champagne gebürstet (22kt Gold)	30 010 662-46
	Chrom	30 010 662-00
	Platin gebürstet	30 010 662-06
	Dark Chrome	30 010 662-19
	Light Gold	30 010 662-26
	Light Gold gebürstet	30 010 662-27
	Schwarz matt	30 010 662-33
	Bronze gebürstet	30 010 662-42
	Champagne (22kt Gold)	30 010 662-47
	Chrom gebürstet	30 010 662-93
	Dark Platinum gebürstet	30 010 662-99

**META Wandventil Kaltwasser ohne Ablaufgarnitur - Champagne gebürstet
(22kt Gold)**

META

30 010 662
mm [inches]

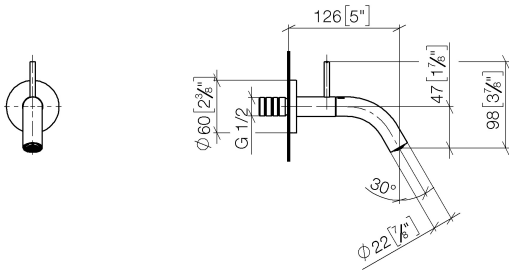

Durchflussdiagramm

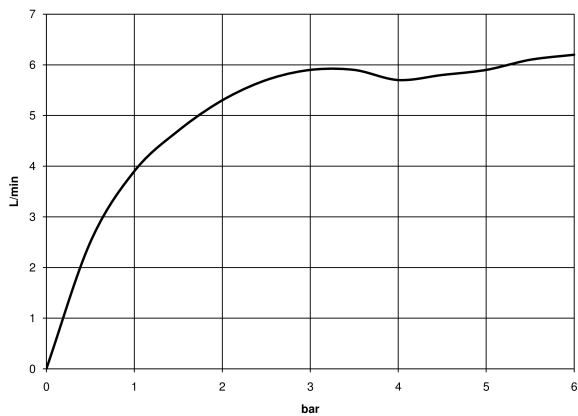

Codes & Standards

DIN 4109

ISO 3822

Ü-Zeichen



**META Wandventil Kaltwasser ohne Ablaufgarnitur - Champagne gebürstet
(22kt Gold)**

META

30 010 662
Zertifikate

LGA_38

30 010 662

Produktversion von 5/1/2022

Ersatzteile für die
anderen
Oberflächenvarianten
finden Sie hier:
Chrom

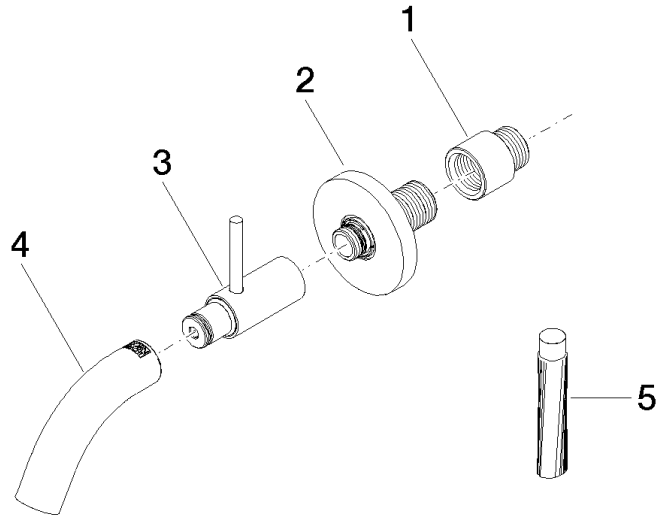



**META Wandventil Kaltwasser ohne Ablaufgarnitur - Champagne gebürstet
(22kt Gold)**

META

30 010 662

Ersatzteilstückliste

Produktversion von 5/1/2022

Nr.	Artikelnummer	Benennung	Verbaumenge	Lieferzeit
	09 24 03 072 10 90	Verlängerung 1/2" x 20 mm -	5	2