

Productinformatieblad

Specificaties



Enkelvoudig contactblok met bevestigingskraag voor behuizing, Harmony XB4, metaal, 1 NO + 1 NC, compacte Push-in

ZB4BZ1055

EAN Code: 3389119039284

Prijs: 14,90 EUR

Hoofd

range of product	Harmony XB4
product of component type	Volledige montage lichaam/contact
device short name	ZB4
materiaal bevestigingskraag	Zamak
verkoop per ondeelbare hoeveelheid	1
koptype	Standaard
type en samenstelling contacten	1 NO + 1 NC
werking contacten	Slow-break
type contactblok	Enkelvoudig
samenstelling apparaat	Bevestigingskraag Contactblok
aansluitingen - aansluitklemmen	Insteek, $\leq 2 \times 1,5 \text{ mm}^2$ met kabeluiteinde met aansluitflensbus In overeenstemming met IEC 60947-1 Insteek, $\geq 1 \times 0,34 \text{ mm}^2$ zonder draadeinddop In overeenstemming met IEC 60947-1

Complementair

CAD totale breedte	46,2 mm
CAD totale hoogte	27,6 mm
CAD totale diepte	30 mm
beschrijving klemmen ISO n°1	(11-12)NC
gewicht product	0,048 kg
contact gebruik	Standaardcontacten
positieve opening	Met In overeenstemming met IEC 60947-5-1 appendix K
bedrijfstraject	1,217 mm (normaal gesloten elektrische status wijzigen) 2,05 mm (normaal open elektrische status wijzigen) 4,3 mm (totale reis)
bedieningskracht	2,25 N normaal gesloten + normaal open elektrische status wijzigen 2,45 N
mechanical durability	10000000 cycles
contact materiaal	Zilverlegering (Ag/Ni)
kortsluitbeveiliging	10 A smelt patroon type gG In overeenstemming met IEC 60947-5-1
lth conventionele thermische stroom in vrije lucht	10 A In overeenstemming met IEC 60947-5-1

De weergegeven prijs is de adviesprijs in euro excl. BTW. Deze kan onderhevig zijn aan korting. Neem contact op met uw lokale distributeur of detailhandel voor de daadwerkelijke prijs

Ui nom isolatiespanning	300 V (vervuilingsgraad) 3) In overeenstemming met IEC 60947-1
Uimp nom. schokgolfspanning	4 kV In overeenstemming met IEC 60947-1
le nom. bedrijfstrom	6 A om 120 V, AC-15, A300 In overeenstemming met IEC 60947-5-1 3 A om 240 V, AC-15, A300 In overeenstemming met IEC 60947-5-1 0,55 A om 125 V, DC-13, Q300 In overeenstemming met IEC 60947-5-1 0,27 A om 250 V, DC-13, Q300 In overeenstemming met IEC 60947-5-1
product presentatie	Basis sub-eenheden

Omgeving

beschermende behandeling	TH
ambient air temperature for storage	-40...70 °C
omgevingstemperatuur voor werking	-40...70 °C
IP beschermingsgraad	IP20 In overeenstemming met IEC 60529
standards	IEC 60947-1 IEC 60947-5-1 IEC 60947-5-4 IEC 60947-5-5 UL 60947-1 UL 60947-5-1 UL 60947-5-5 UL 1059 UL 486E CSA C22.2 Nr 60947-1 CSA C22.2 Nr 60947-5-1 CSA C22.2 Nr. 158 CSA C22.2 Nr 65 IACS E10
product certifications	EAC ECEE CB-regeling CCC UL CSA
trilling bestendigheid	5 gn (f= 10...500 Hz) In overeenstemming met IEC 60068-2-6 25 mm piek-piek (f= 2...10 Hz) In overeenstemming met IEC 60068-2-6
schokbestendigheid	25 gn (duur = 6 ms) voor 1000 schokken op elke as In overeenstemming met IEC 60068-2-27 30 gn (duur = 18 ms) voor halve sinusgolf versnelling In overeenstemming met IEC 60068-2-27 50 gn (duur = 11 ms) voor halve sinusgolf versnelling In overeenstemming met IEC 60068-2-27

Verpakkingseenheid

Eenheidstype van verpakking 1	PCE
Aantal eenheden in verpakking 1	1
verpakking 1 hoogte	3,400 cm
verpakking 1 breedte	4,300 cm
verpakking 1 lengte	5,300 cm
verpakking_1_gewicht	53,000 g
Eenheidstype van verpakking 2	S02
Aantal eenheden in verpakking 2	100
verpakking 2 hoogte	15,000 cm
verpakking 2 breedte	30,000 cm
verpakking 2 lengte	40,000 cm
verpakking 2 gewicht	5,577 kg

contractuele waarborg

Garantie (in maanden)

18

Schneider Electric wil tegen 2050 de Net Zero-status hebben bereikt via partnerschappen in de toeleveringsketen, materialen met een lagere impact en circulariteit via onze doorlopende campagne "Use Better, Use Longer, Use Again" om de levensduur van producten en de recycleerbaarheid te verlengen.

[Uitleg van Environmental Data >](#)

[Hoe evalueren we de duurzaamheid van producten? >](#)

Milieuoetafdruk

Totale levenscyclus ecologische voetafdruk	0.6 kg CO2 eq.
Koolstofvoetafdruk van de fabricagefase [A1–A3]	0.4 kg CO2 eq.
Koolstofvoetafdruk van de distributiefase [A4]	0 kg CO2 eq.
Koolstofvoetafdruk van de installatiefase [A5]	0 kg CO2 eq.
Koolstofvoetafdruk van de gebruiksfase [B2, B3, B4, B6]	0.1 kg CO2 eq.
Koolstofvoetafdruk van de einde-levensfase [C1–C4]	0.1 kg CO2 eq.

Use Better

Materialen en verpakking

Gemiddeld percentage gerecycleerde kunststof	23 %
Gemiddeld percentage gerecycleerd metaal	16 %
Pakket met gerecycleerd karton	Ja
Verpakkingen zonder kunststof	Ja
RoHS-richtlijn van de EU	Conform
REACH-verordening	Referentie bevat geen SVHC boven drempelwaarde

Use Longer

Levensduurverlenging

Reparatie	Nee
-----------	-----

Use Again

Herverpakken en herfabriceren

Circulair Profiel	Informatie over einde levensduur
Terugname	Ja
WEEE-label	 Het product moet op markten van de Europese Unie worden afgevoerd volgens specifieke afvalinzamelingsregels en mag nooit in een gewone vuilnisbak terecht komen.

Dimensions Drawings

Dimensions

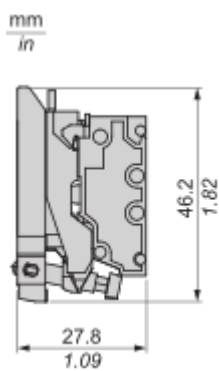

Mounting and Clearance

Mounting

Mounting and Unmounting

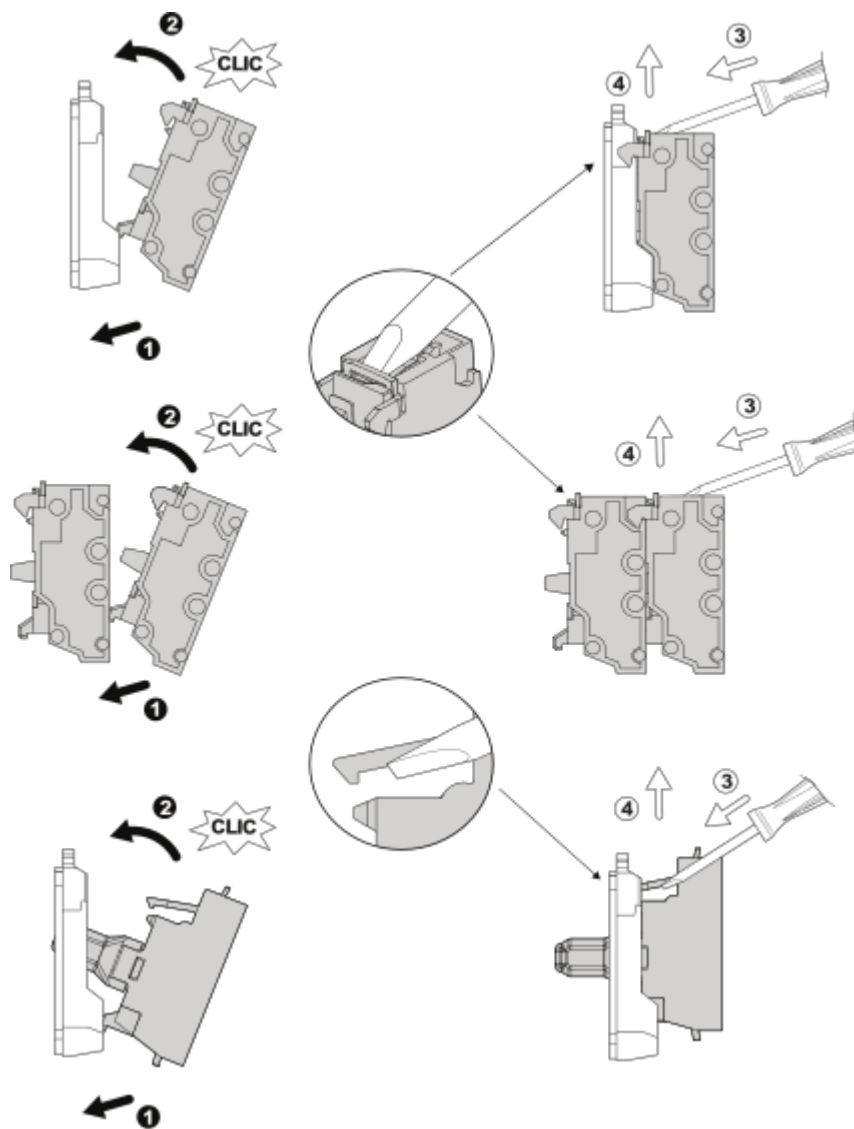

Panel cut-out Dimension

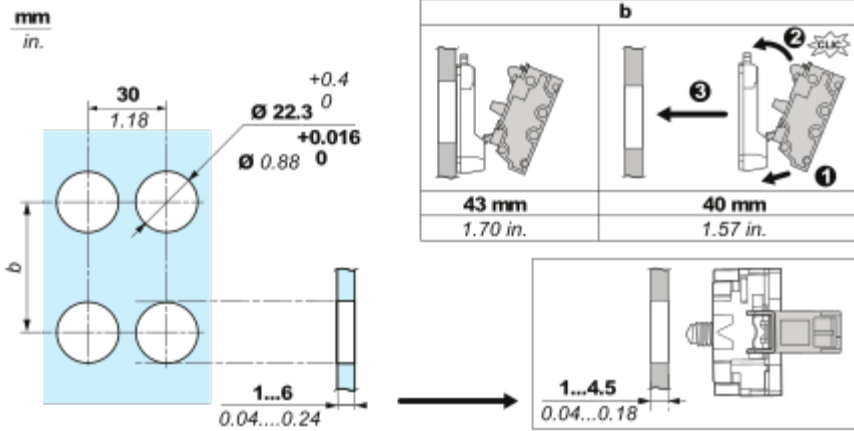

Connections and Schema

Wiring

Wiring and Unwiring



mm	8
in.	0.32
mm ²	0.34...1.5
AWG	22...16



mm	8	8	8	(1) Max
in.	0.32	0.32	0.32	
mm ²	0.34...1.5	0.34...1	0.34...1.5	1.9 mm
AWG	22...16	22...18	22...16	0.07 in.
		2.4 mm		0.09 in.

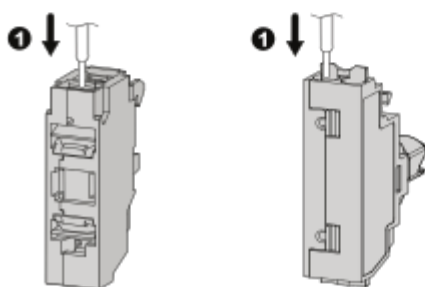

Technical Illustration

Dimensions

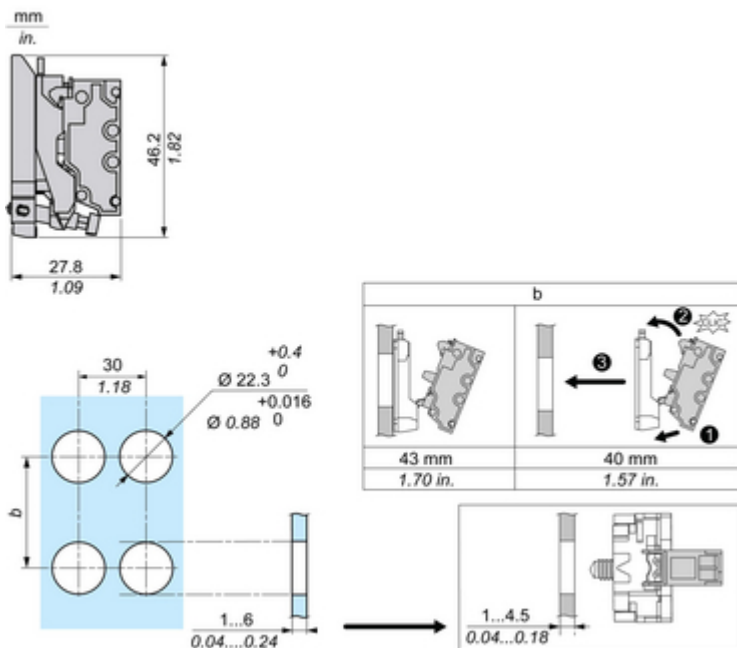

Technical Illustration

Wiring diagram

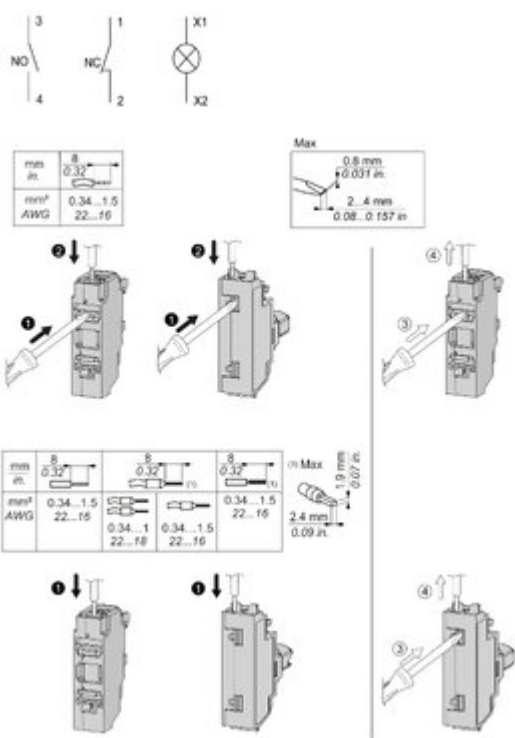

Offer Marketing Illustration

Product benefits / Features

Technical Benefits

Harmony XB4/XB5 Compact Push-in blocks

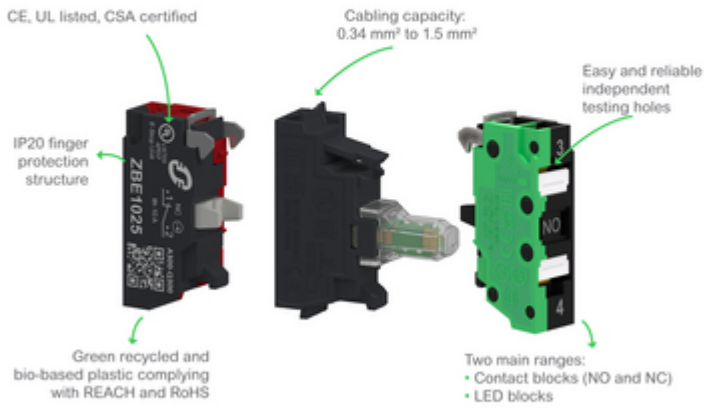

Offer Marketing Illustration

Product benefits / Features

Features
Harmony XB4/XB5 Compact Push-in blocks



37% thinner than a standard block

Installation costs saved through reduced wiring time and effort

Fully compatible with current Harmony offer

Available as single block, sub-assemblies and complete units (both plastic and metal ranges)

Simplified inventory management



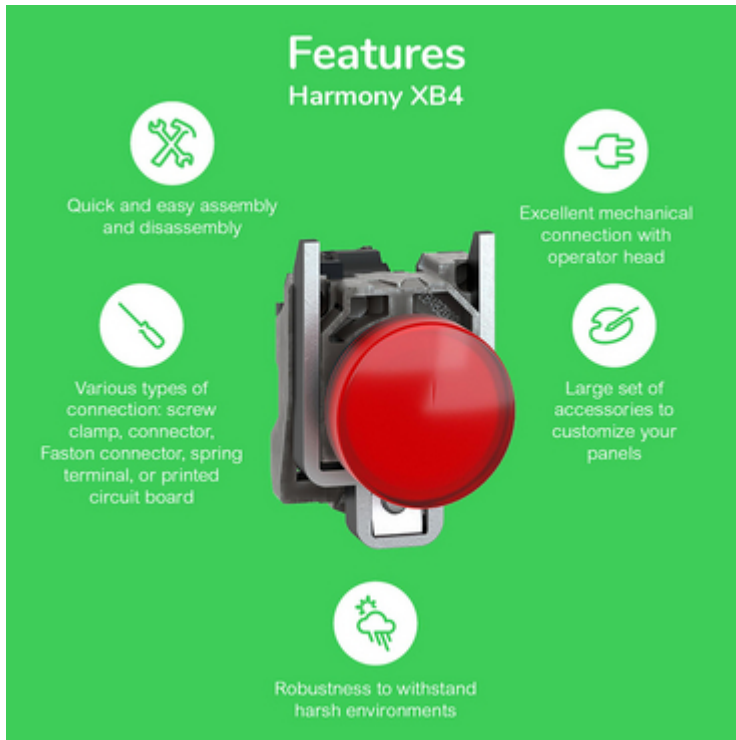

Offer Marketing Illustration

Product benefits / Features



The infographic features a central image of a red Schneider XB4 terminal block. Surrounding it are five circular icons, each with a corresponding text description of a feature. The background is a solid green color.

Features Harmony XB4

-  Quick and easy assembly and disassembly
-  Various types of connection: screw clamp, connector, Faston connector, spring terminal, or printed circuit board
-  Excellent mechanical connection with operator head
-  Large set of accessories to customize your panels
-  Robustness to withstand harsh environments

Offer Marketing Illustration

Product benefits / Features

Technical Benefits

Harmony XB4

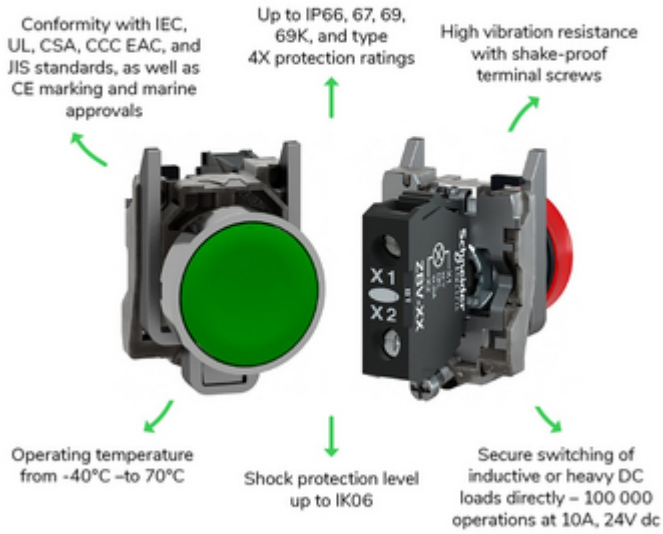

Image of product / Alternate images

Alternative

