

Data Sheet | Item Number: 261-102

2-conductor terminal strip; without push-buttons; with fixing flanges; 2-pole; for screw or similar mounting types; Fixing hole 3.2 mm Ø; 2.5 mm²; CAGE CLAMP®; gray

<https://www.wago.com/261-102>

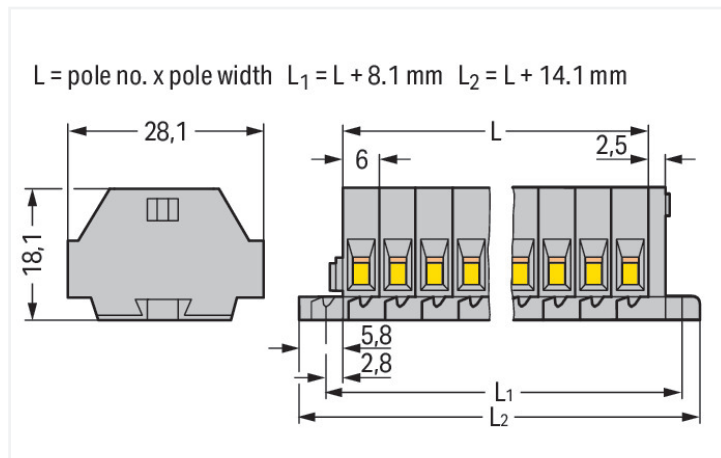
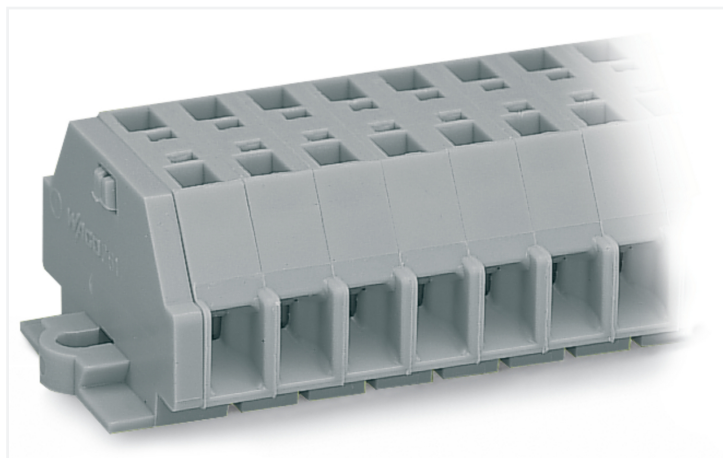

Color: ■ gray

Similar to illustration

Dimensions in mm

Through terminal block, 261 Series, CAGE CLAMP®

Connect conductors quickly and safely with this through terminal block (item number 261-102). Conductors can only be connected to this through terminal block if their strip length is between 8 and 9 mm. Our mini rail-mount terminal blocks are perfect for working in confined spaces thanks to their compact design. With various mounting and actuation options, they offer maximum flexibility. This product features conductor terminals and utilizes CAGE CLAMP®. Our proven universal connection known as CAGE CLAMP® is industry-leading when it comes to connection technology and electrical interconnections. Dimensions: (26.1 x 28.1 x 18.1) mm (width x height x depth). This through terminal block is suitable for conductor cross sections ranging from 0.08 mm² to 2.5 mm².

An operating tool is used to operate this mini rail-mount terminal block.

Electrical data

Ratings per IEC/EN

Nominal voltage (III/3)	500 V
Rated impulse withstand voltage (III / 3)	6 kV
Rated current	24 A
Legend (ratings)	(III / 3) ≙ Overvoltage category III / Pollution degree 3

Approvals per

UL 1059

Use group	B	C	D
Rated voltage	300 V	300 V	600 V
Rated current	15 A	15 A	5 A

Approvals per

CSA 22.2 No 158

Use group	B	C	D
Rated voltage	-	300 V	600 V
Rated current	-	10 A	5 A

General information

Wiring direction	Side-entry wiring
------------------	-------------------

Connection Data

Clamping units	4
Total number of potentials	2
Number of levels	1

Connection 1

Connection technology	CAGE CLAMP®
Actuation type	Operating tool
Connectable conductor materials	Copper
Solid conductor	0.08 ... 2.5 mm ² / 28 ... 14 AWG
Fine-stranded conductor	0.08 ... 2.5 mm ² / 28 ... 14 AWG
Strip length	8 ... 9 mm / 0.31 ... 0.35 inches
Pole number	2
Wiring direction	Side-entry wiring

Physical data

Width	26.1 mm / 1.028 inches
Height	28.1 mm / 1.106 inches
Depth	18.1 mm / 0.713 inches
Module width	6 mm / 0.236 inches

Mechanical data

Design	horizontal type
Mounting type	Mounting flange
Marking level	Side marking

Material data

Note (material data)	Information on material specifications can be found here
Color	gray
Material group	I
Insulation material (main housing)	Polyamide (PA66)
Flammability class per UL94	V0
Fire load	0.115 MJ
Halogen-free	Yes
Weight	5.7 g

Commercial data

PU (SPU)	100 pcs
Packaging type	Box
Country of origin	DE
GTIN	4055143764124
Customs tariff number	85369010000

Product Classification

UNSPSC	39121410
eCl@ss 10.0	27-14-11-06
eCl@ss 9.0	27-14-11-06
ETIM 9.0	EC001284
ETIM 10.0	EC001284
ECCN	NO US CLASSIFICATION

Environmental Product Compliance

RoHS Compliance Status

Compliant, No Exemption

Approvals / Certificates

General approvals



Approval	Standard	Certificate Name
CCA DEKRA Certification B.V.	EN 60998	NTR-NL 6509
KEMA/KEUR DEKRA Certification B.V.	EN 60998	2110272.02
UR Underwriters Laboratories Inc.	UL 1059	E45172

Declarations of conformity and manufacturer's declarations

Approval	Standard	Certificate Name
EU-Declaration of Conformity WAGO GmbH & Co. KG	-	-
UK-Declaration of Conformity WAGO GmbH & Co. KG	-	-

Approvals for marine applications



Approval	Standard	Certificate Name
ABS American Bureau of Shipping	-	24-0095979-PDA
BV Bureau Veritas S.A.	EN 60947	07436/G0 BV
DNV DNV GL SE	-	TAE00001V2
LR Lloyds Register	IEC 60998	LR22173030TA
PRS Polski Rejestr Statków	-	TE/1094/880590/23

Downloads



Environmental Product Compliance

Compliance Search

 Environmental Product
Compliance 261-102
 

Documentation

Bid Text

261-102	14.06.2017	doc 24.50 KB	
261-102	19.02.2019	xml 3.11 KB	

CAD/CAE-Data

CAD data	CAE data
2D/3D Models 261-102	EPLAN Data Portal 261-102
	WSCAD Universe 261-102
	ZUKEN Portal 261-102

1 Compatible Products

1.1 Optional Accessories

1.1.1 Ferrule

1.1.1.1 Ferrule

 Item No.: 216-301 Ferrule; Sleeve for 0.25 mm ² / AWG 24; insulated; electro-tin plated; yellow	 Item No.: 216-302 Ferrule; Sleeve for 0.34 mm ² / 22 AWG; insulated; electro-tin plated; light turquoise	 Item No.: 216-201 Ferrule; Sleeve for 0.5 mm ² / 20 AWG; insulated; electro-tin plated; electrolytic copper; acc. to DIN 46228, Part 4/09.90; white	 Item No.: 216-101 Ferrule; Sleeve for 0.5 mm ² / AWG 22; un-insulated; electro-tin plated; silver-colored
 Item No.: 216-202 Ferrule; Sleeve for 0.75 mm ² / 18 AWG; insulated; electro-tin plated; gray	 Item No.: 216-102 Ferrule; Sleeve for 0.75 mm ² / AWG 20; un-insulated; electro-tin plated; silver-colored	 Item No.: 216-203 Ferrule; Sleeve for 1 mm ² / AWG 18; insulated; electro-tin plated; red	 Item No.: 216-103 Ferrule; Sleeve for 1 mm ² / AWG 18; un-insulated; electro-tin plated
 Item No.: 216-204 Ferrule; Sleeve for 1.5 mm ² / AWG 16; insulated; electro-tin plated; black	 Item No.: 216-104 Ferrule; Sleeve for 1.5 mm ² / AWG 16; un-insulated; electro-tin plated; silver-colored	 Item No.: 216-205 Ferrule; Sleeve for 2.08 mm ² / AWG 14; insulated; electro-tin plated; yellow	 Item No.: 216-206 Ferrule; Sleeve for 2.5 mm ² / AWG 14; insulated; electro-tin plated; blue
 Item No.: 216-106 Ferrule; Sleeve for 2.5 mm ² / AWG 14; un-insulated; electro-tin plated; silver-colored			

1.1.2 Installation

1.1.2.1 Mounting accessories

 Item No.: 209-137 Mounting adapter; can be used as end stop; 6.5 mm wide; gray	 Item No.: 209-123 Mounting foot with screw; can be screwed on terminal blocks with fixing flange; 6.4 mm wide; gray
--	---

1.1.3 Jumper

1.1.3.1 Jumper



Item No.: 261-402

Jumper; for conductor entry; 2-way; insulated; gray

1.1.4 Marking

1.1.4.1 Marking strip



Item No.: 210-833

Marking strips; 25 m on roll; 6 mm wide; plain; Self-adhesive; white

1.1.5 Test and measurement

1.1.5.1 Testing accessories



Item No.: 261-404

Test plug module; with locking latches; modular; for 2-conductor terminal blocks; for 261 Series; gray



Item No.: 249-136

Test plug module; without locking device; modular; for 2-conductor terminal blocks; gray

1.1.6 Tool

1.1.6.1 Operating tool



Item No.: 210-658

Operating tool; Blade: 3.5 x 0.5 mm; with a partially insulated shaft; angled; short; multicoloured



Item No.: 210-720

Operating tool; Blade: 3.5 x 0.5 mm; with a partially insulated shaft; multicoloured



Item No.: 210-657

Operating tool; Blade: 3.5 x 0.5 mm; with a partially insulated shaft; short; multicoloured

Installation Notes

Conductor termination

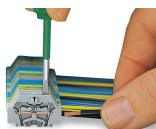

CAGE CLAMP® connection

Inserting a conductor.

With ferruled conductors, it is necessary to use a terminal block one size larger than the conductor's nominal cross-section.

Commoning



Commoning with comb-style jumper bar.

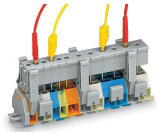

Testing via test plug modules snapped onto a terminal strip – wired or unwired. As touch contact is made with the CAGE CLAMP® (spring steel) unit, this testing type is limited to maximum 0.5 A.

Distance between locking devices must be approximately 35 ... 40 mm!

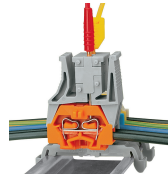

Testing after the conductors have been terminated.

Installation

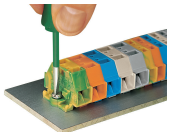

Mounting and securing a terminal strip directly to the plate via screw-type flanges.

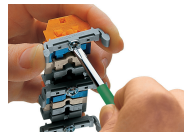

Terminal strip with mounting flanges
Screwing a mounting foot (209-123).
(Distance between mounting feet: approx. 25 ... 30 mm)

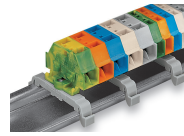

Terminal strip; with mounting flanges; for DIN-35 rail



Terminal strip with mounting flanges, for screw or similar mounting types, 3.2 mm mounting hole diameter (with 209-123 Mounting Foot also for DIN-35 rail)

Marking



Marking with self-adhesive marking strips.



Marking by direct printing (upon request).

Subject to changes. Please also observe the further product documentation!

Current addresses can be found at: www.wago.com