

## Data Sheet | Item Number: 2006-1621/1000-836

2-conductor fuse terminal block; with pivoting fuse holder; for 5 x 30 mm miniature metric fuse; with blown fuse indication by LED; 230 V; for DIN-rail 35 x 15 and 35 x 7.5; 6 mm<sup>2</sup>; Push-in CAGE CLAMP®; 6,00 mm<sup>2</sup>; gray

<https://www.wago.com/2006-1621/1000-836>

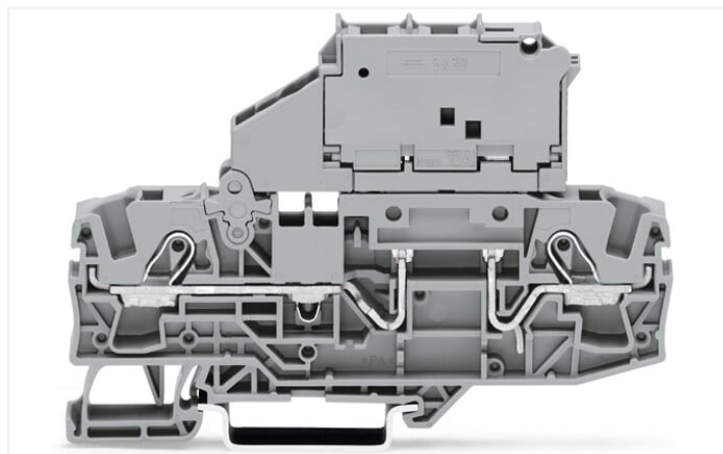

Color: ■ gray

Similar to illustration

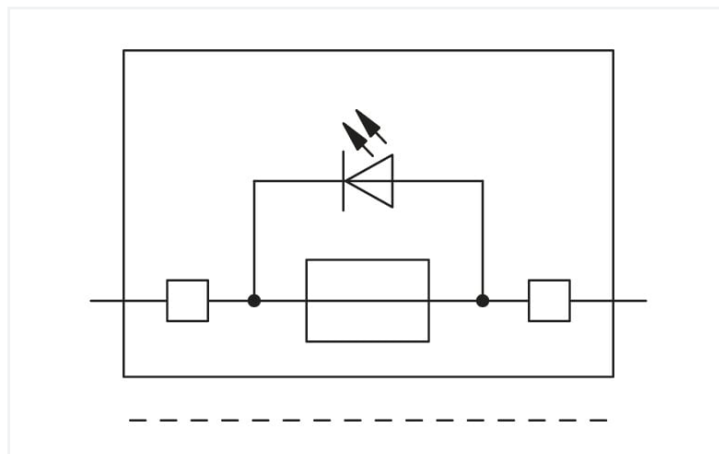

### Electrical data

Ratings per	IEC/EN 60947-7-3		
Overvoltage category	III	III	II
Pollution degree	3	2	2
Nominal voltage	800 V	-	-
Rated surge voltage	8 kV	-	-
Rated current	10 A	-	-

Approvals per	UL 1059		
Use group	B	C	D
Rated voltage	230 V	230 V	-
Rated current	15 A	15 A	-

Approvals per	CSA 22.2 No 158		
Use group	B	C	D
Rated voltage	600 V	600 V	-
Rated current	15 A	15 A	-

Power Loss	
Power loss $P_{I(\max)}$ (note)	When selecting glass cartridge fuses, make sure that the maximum power loss listed below is not exceeded. The power loss is determined according to IEC or EN 60947-7-3/VDE 0611-6 at 23°C. The temperature rise of the terminal block must be checked according to their application and mounting. Higher ambient temperatures represent an additional impact on miniature fuses. Therefore, in such applications, the rated current must be reduced if necessary. More details are available from the manufacturers.
Power loss $P_I$ max. overload and short-circuit protection (individual arrangement)	1.6 W
Power loss $P_I$ max. overload and short-circuit protection (group arrangement)	1.6 W
Power loss $P_I$ max. short-circuit protection (individual arrangement)	2.5 W
Power loss $P_I$ max. short-circuit protection (group arrangement)	2.5 W

### General information

Fuse receptacle	pivoting
Fuse type	Cylindrical fuse; 5 x 30 mm

## Connection data

Connection points	2
Total number of potentials	1
Number of levels	1
Number of jumper slots	2

## Connection 1

Connection technology	Push-in CAGE CLAMP®
Actuation type	Operating tool
Connectable conductor materials	Copper
Nominal cross-section	6 mm <sup>2</sup>
Solid conductor	0.5 ... 10 mm <sup>2</sup> / 20 ... 8 AWG
Solid conductor; push-in termination	1 ... 10 mm <sup>2</sup> / 14 ... 8 AWG
Fine-stranded conductor	0.5 ... 10 mm <sup>2</sup> / 20 ... 8 AWG
Fine-stranded conductor; with insulated ferrule	0.5 ... 6 mm <sup>2</sup> / 20 ... 10 AWG
Fine-stranded conductor; with ferrule; push-in termination	2.5 ... 6 mm <sup>2</sup> / 16 ... 10 AWG
Note (conductor cross-section)	Depending on the conductor characteristic, a conductor with a smaller cross-section can also be inserted via push-in termination.
Strip length	13 ... 15 mm / 0.51 ... 0.59 inches
Wiring direction	Front-entry wiring

## Physical data

Width	7.5 mm / 0.295 inches
Height	96.3 mm / 3.791 inches
Depth from upper-edge of DIN-rail	59 mm / 2.323 inches

## Mechanical data

Mounting type	DIN-35 rail
Marking level	Center/side marking

## Material data

Note (material data)	<a href="https://www.wago.com/us/material-specifications">Information on material specifications can be found here</a>
Color	gray
Material group	I
Insulation material	Polyamide (PA66)
Flammability class per UL94	V0
Fire load	0.457 MJ
Weight	25.2 g

## Environmental requirements

Processing temperature	-35 ... +50 °C
Continuous operating temperature	-60 ... +50 °C

### Commercial data

Product Group	22 (TOPJOB S)
eCl@ss 10.0	27-14-11-16
eCl@ss 9.0	27-14-11-16
ETIM 8.0	EC000899
ETIM 7.0	EC000899
PU (SPU)	25 pcs
Packaging type	Box
Country of origin	DE
GTIN	4045454824037
Customs tariff number	85369095000

### Environmental Product Compliance

CAS-No.	7439-92-1
REACH Candidate List Substance	Lead
RoHS Compliance Status	Compliant,With Exemption
RoHS Exemption	7(a) 7(c)-I
SCIP notification number (Austria)	a89e63f7-aaba-4dd3-9b2c-0610aff465a2
SCIP notification number (Belgium)	7423626b-0cb6-4c5b-b0c9-53a7d6dc3fbd
SCIP notification number (Bulgaria)	c0be90f5-f58f-4bc2-bc61-716f036cbc64
SCIP notification number (Czech Republic)	7fd454c6-eeae-48ed-983d-a6e3fb618d50
SCIP notification number (Denmark)	fa47d2cb-94dc-47e4-a773-e6e44a66c5d3
SCIP notification number (Finland)	fe9e7403-9bc7-431d-ab86-80783a3712f0
SCIP notification number (France)	f3c79cd3-41c1-4ca9-afc6-27e6bd0e35a2
SCIP notification number (Germany)	4d8c826a-61e1-46f4-a878-be2bad93c0f3
SCIP notification number (Hungary)	4cd0fce3-2b8f-4499-9039-de3f1987070c
SCIP notification number (Italy)	4fbfd762-6d22-47b6-8600-d9de240bdd05
SCIP notification number (Netherlands)	ab945769-e2ec-4d5d-ae14-a6156110dfac
SCIP notification number (Poland)	3f2d18a5-1be1-4659-a543-368697b41ded
SCIP notification number (Romania)	433f8eb8-355f-4b2a-aa8f-cae9cd2904b7
SCIP notification number (Sweden)	25c5bc25-ec41-4645-921e-cd1224034cb0

### Approvals / Certificates

#### General approvals



Approval	Standard	Certificate Name
CCA DEKRA Certification B.V.	IEC 60947	71-122840 REV.1
CCA DEKRA Certification B.V.	EN 60947	NTR NL 7925/1
CSA DEKRA Certification B.V.	C22.2 No. 158	1543858
UL UL International Germany GmbH	UL 1059	E45172

#### Declarations of conformity and manufacturer's declarations



Approval	Standard	Certificate Name
EU-Declaration of Confor- mity WAGO GmbH & Co. KG	-	-
Railway WAGO GmbH & Co. KG	-	Railway Ready
UK-Declaration of Confor- mity WAGO GmbH & Co. KG	-	-

Approvals for marine applications



Approval	Standard	Certificate Name
ABS American Bureau of Ship- ping	EN 60947	20-HG1941090-PDA
DNV GL Det Norske Veritas, Ger- manischer Lloyd	-	TAE00001V2

Downloads

Environmental Product Compliance

Compliance Search
Environmental Product Compliance 2006-1621/1000-836



Documentation

Additional Information
Technical Section

pdf  
2240.62 KB



Bid Text				
2006-1621/1000-836	18.04.2019	xml	4.27 KB	
2006-1621/1000-836	17.04.2019	docx	15.88 KB	

CAD/CAE-Data

CAD data
2D/3D Models 2006-1621/1000-836



CAE data				
EPLAN Data Portal 2006-1621/1000-836				
WSCAD Universe 2006-1621/1000-836				
ZUKEN Portal 2006-1621/1000-836				

## 1 Compatible Products

### 1.1 Required Accessories

#### 1.1.1 End plate

##### 1.1.1.1 End plate



**Item No.: 2006-1691**

End and intermediate plate; 1 mm thick; gray



**Item No.: 2006-1692**

End and intermediate plate; 1 mm thick; orange

### 1.2 Optional Accessories

#### 1.2.1 Cover

##### 1.2.1.1 Cover



**Item No.: 2006-191**

Lockout cap; for wire insertion and actuating opening; gray

#### 1.2.2 DIN-rail

##### 1.2.2.1 Mounting accessories



**Item No.: 210-196**

Aluminum carrier rail; 35 x 8.2 mm; 1.6 mm thick; 2 m long; unslotted; similar to EN 60715; silver-colored



**Item No.: 210-198**

Copper carrier rail; 35 x 15 mm; 2.3 mm thick; 2 m long; unslotted; according to EN 60715; copper-colored



**Item No.: 210-508**

Steel carrier rail; 35 x 15 mm; 1.5 mm thick; 2 m long; slotted; galvanized; similar to EN 60715; silver-colored



**Item No.: 210-197**

Steel carrier rail; 35 x 15 mm; 1.5 mm thick; 2 m long; slotted; similar to EN 60715; silver-colored



**Item No.: 210-506**

Steel carrier rail; 35 x 15 mm; 1.5 mm thick; 2 m long; unslotted; galvanized; similar to EN 60715; silver-colored



**Item No.: 210-114**

Steel carrier rail; 35 x 15 mm; 1.5 mm thick; 2 m long; unslotted; similar to EN 60715; silver-colored



**Item No.: 210-118**

Steel carrier rail; 35 x 15 mm; 2.3 mm thick; 2 m long; unslotted; according to EN 60715; silver-colored



**Item No.: 210-115**

Steel carrier rail; 35 x 7.5 mm; 1 mm thick; 2 m long; slotted; according to EN 60715; "Hole width 18 mm; silver-colored



**Item No.: 210-112**

Steel carrier rail; 35 x 7.5 mm; 1 mm thick; 2 m long; slotted; according to EN 60715; "Hole width 25 mm; silver-colored



**Item No.: 210-504**

Steel carrier rail; 35 x 7.5 mm; 1 mm thick; 2 m long; slotted; galvanized; according to EN 60715; silver-colored



**Item No.: 210-113**

Steel carrier rail; 35 x 7.5 mm; 1 mm thick; 2 m long; unslotted; according to EN 60715; silver-colored



**Item No.: 210-505**

Steel carrier rail; 35 x 7.5 mm; 1 mm thick; 2 m long; unslotted; galvanized; according to EN 60715; silver-colored

#### 1.2.3 End plate

##### 1.2.3.1 End plate



**Item No.: 2006-991**

End plate for fuse terminal blocks; 2 mm thick; gray



**Item No.: 2006-992**

End plate for fuse terminal blocks; 2 mm thick; orange

## 1.2.4 Ferrule

### 1.2.4.1 Ferrule



**Item No.: 216-262**

Ferrule; Sleeve for 0.75 mm<sup>2</sup> / 18 AWG; insulated; electro-tin plated; electrolytic copper; gastight crimped; acc. to DIN 46228, Part 4/09.90; gray



**Item No.: 216-263**

Ferrule; Sleeve for 1 mm<sup>2</sup> / AWG 18; insulated; electro-tin plated; electrolytic copper; gastight crimped; acc. to DIN 46228, Part 4/09.90; red



**Item No.: 216-264**

Ferrule; Sleeve for 1.5 mm<sup>2</sup> / AWG 16; insulated; electro-tin plated; electrolytic copper; gastight crimped; acc. to DIN 46228, Part 4/09.90; black



**Item No.: 216-266**

Ferrule; Sleeve for 2.5 mm<sup>2</sup> / AWG 14; insulated; electro-tin plated; electrolytic copper; gastight crimped; acc. to DIN 46228, Part 4/09.90; blue



**Item No.: 216-267**

Ferrule; Sleeve for 4 mm<sup>2</sup> / AWG 12; insulated; electro-tin plated; electrolytic copper; gastight crimped; acc. to DIN 46228, Part 4/09.90; gray



**Item No.: 216-208**

Ferrule; Sleeve for 6 mm<sup>2</sup> / AWG 10; insulated; electro-tin plated; electrolytic copper; gastight crimped; acc. to DIN 46228, Part 4/09.90; yellow

## 1.2.5 Installation

### 1.2.5.1 Cover



**Item No.: 709-156**

Cover; Type 3; suitable for cover carrier, type 3; 1 m long; transparent

### 1.2.5.2 Cover carrier



**Item No.: 709-169**

Cover carrier; Type 3; incl. fixing/retaining screws and knurled nut; suitable for 279 to 282 and 880 Series rail-mounted terminal blocks; suitable for 264 Series miniature rail-mounted terminal blocks; suitable for 270 Series sensor and actuator terminal blocks; gray

## 1.2.6 Jumper

### 1.2.6.1 Jumper



**Item No.: 2006-402**

Jumper; 2-way; insulated; light gray



**Item No.: 2006-403**

Jumper; 3-way; insulated; light gray



**Item No.: 2006-404**

Jumper; 4-way; insulated; light gray



**Item No.: 2006-405**

Jumper; 5-way; insulated; light gray



**Item No.: 2006-433**

Jumper; from 1 to 3; insulated; light gray



**Item No.: 2006-434**

Jumper; from 1 to 4; insulated; light gray



**Item No.: 2006-435**

Jumper; from 1 to 5; insulated; light gray



**Item No.: 2006-405/011-000**

Star point jumper; 3-way; insulated; light gray

## 1.2.7 Locking system

### 1.2.7.1 Locking system



**Item No.: 210-254**

Interlocking link; mechanically locks multiple links; 1 m long; transparent

## 1.2.8 Marking

### 1.2.8.1 Marker

**Item No.: 2009-145/000-006**

Mini-WSB Inline; for Smart Printer; 1700 pieces on roll; stretchable 5 - 5.2 mm; plain; snap-on type; blue

**Item No.: 2009-145/000-007**

Mini-WSB Inline; for Smart Printer; 1700 pieces on roll; stretchable 5 - 5.2 mm; plain; snap-on type; gray

**Item No.: 2009-145/000-023**

Mini-WSB Inline; for Smart Printer; 1700 pieces on roll; stretchable 5 - 5.2 mm; plain; snap-on type; green

**Item No.: 2009-145/000-012**

Mini-WSB Inline; for Smart Printer; 1700 pieces on roll; stretchable 5 - 5.2 mm; plain; snap-on type; orange

**Item No.: 2009-145/000-005**

Mini-WSB Inline; for Smart Printer; 1700 pieces on roll; stretchable 5 - 5.2 mm; plain; snap-on type; red

**Item No.: 2009-145/000-024**

Mini-WSB Inline; for Smart Printer; 1700 pieces on roll; stretchable 5 - 5.2 mm; plain; snap-on type; violet

**Item No.: 2009-145**

Mini-WSB Inline; for Smart Printer; 1700 pieces on roll; stretchable 5 - 5.2 mm; plain; snap-on type; white

**Item No.: 2009-145/000-002**

Mini-WSB Inline; for Smart Printer; 1700 pieces on roll; stretchable 5 - 5.2 mm; plain; snap-on type; yellow



**Item No.: 248-501/000-006**

Mini-WSB marking card; as card; not stretchable; plain; snap-on type; blue

**Item No.: 248-501/000-007**

Mini-WSB marking card; as card; not stretchable; plain; snap-on type; gray

**Item No.: 248-501/000-023**

Mini-WSB marking card; as card; not stretchable; plain; snap-on type; green

**Item No.: 248-501/000-017**

Mini-WSB marking card; as card; not stretchable; plain; snap-on type; light green



**Item No.: 248-501/000-012**

Mini-WSB marking card; as card; not stretchable; plain; snap-on type; orange

**Item No.: 248-501/000-005**

Mini-WSB marking card; as card; not stretchable; plain; snap-on type; red

**Item No.: 248-501/000-024**

Mini-WSB marking card; as card; not stretchable; plain; snap-on type; violet

**Item No.: 248-501**

Mini-WSB marking card; as card; not stretchable; plain; snap-on type; white



**Item No.: 248-501/000-002**

Mini-WSB marking card; as card; not stretchable; plain; snap-on type; yellow

**Item No.: 793-5501/000-006**

WMB marking card; as card; for terminal block width 5 - 17.5 mm; stretchable 5 - 5.2 mm; plain; snap-on type; blue

**Item No.: 793-5501/000-014**

WMB marking card; as card; for terminal block width 5 - 17.5 mm; stretchable 5 - 5.2 mm; plain; snap-on type; brown

**Item No.: 793-5501/000-007**

WMB marking card; as card; for terminal block width 5 - 17.5 mm; stretchable 5 - 5.2 mm; plain; snap-on type; gray



**Item No.: 793-5501/000-023**

WMB marking card; as card; for terminal block width 5 - 17.5 mm; stretchable 5 - 5.2 mm; plain; snap-on type; green

**Item No.: 793-5501/000-017**

WMB marking card; as card; for terminal block width 5 - 17.5 mm; stretchable 5 - 5.2 mm; plain; snap-on type; light green

**Item No.: 793-5501/000-012**

WMB marking card; as card; for terminal block width 5 - 17.5 mm; stretchable 5 - 5.2 mm; plain; snap-on type; orange

**Item No.: 793-5501/000-005**

WMB marking card; as card; for terminal block width 5 - 17.5 mm; stretchable 5 - 5.2 mm; plain; snap-on type; red



**Item No.: 793-5501/000-024**

WMB marking card; as card; for terminal block width 5 - 17.5 mm; stretchable 5 - 5.2 mm; plain; snap-on type; violet

**Item No.: 793-5501**

WMB marking card; as card; for terminal block width 5 - 17.5 mm; stretchable 5 - 5.2 mm; plain; snap-on type; white

**Item No.: 793-5501/000-002**

WMB marking card; as card; for terminal block width 5 - 17.5 mm; stretchable 5 - 5.2 mm; plain; snap-on type; yellow

**Item No.: 793-501/000-006**

WMB marking card; as card; not stretchable; plain; snap-on type; blue



**Item No.: 793-501/000-007**

WMB marking card; as card; not stretchable; plain; snap-on type; gray

**Item No.: 793-501/000-023**

WMB marking card; as card; not stretchable; plain; snap-on type; green

**Item No.: 793-501/000-017**

WMB marking card; as card; not stretchable; plain; snap-on type; light green

**Item No.: 793-501/000-012**

WMB marking card; as card; not stretchable; plain; snap-on type; orange



**Item No.: 793-501/000-005**

WMB marking card; as card; not stretchable; plain; snap-on type; red

**Item No.: 793-501/000-024**

WMB marking card; as card; not stretchable; plain; snap-on type; violet

**Item No.: 793-501**

WMB marking card; as card; not stretchable; plain; snap-on type; white

**Item No.: 793-501/000-002**

WMB marking card; as card; not stretchable; plain; snap-on type; yellow

### 1.2.8.1 Marker



**Item No.: 2009-115/000-006**

WMB-Inline; for Smart Printer; 1500 pieces on roll; stretchable 5 - 5.2 mm; plain; snap-on type; blue



**Item No.: 2009-115/000-007**

WMB-Inline; for Smart Printer; 1500 pieces on roll; stretchable 5 - 5.2 mm; plain; snap-on type; gray



**Item No.: 2009-115/000-023**

WMB-Inline; for Smart Printer; 1500 pieces on roll; stretchable 5 - 5.2 mm; plain; snap-on type; green



**Item No.: 2009-115/000-017**

WMB-Inline; for Smart Printer; 1500 pieces on roll; stretchable 5 - 5.2 mm; plain; snap-on type; light green



**Item No.: 2009-115/000-012**

WMB-Inline; for Smart Printer; 1500 pieces on roll; stretchable 5 - 5.2 mm; plain; snap-on type; orange



**Item No.: 2009-115/000-005**

WMB-Inline; for Smart Printer; 1500 pieces on roll; stretchable 5 - 5.2 mm; plain; snap-on type; red



**Item No.: 2009-115/000-024**

WMB-Inline; for Smart Printer; 1500 pieces on roll; stretchable 5 - 5.2 mm; plain; snap-on type; violet



**Item No.: 2009-115**

WMB-Inline; for Smart Printer; 1500 pieces on roll; stretchable 5 - 5.2 mm; plain; snap-on type; white



**Item No.: 2009-115/000-002**

WMB-Inline; for Smart Printer; 1500 pieces on roll; stretchable 5 - 5.2 mm; plain; snap-on type; yellow

### 1.2.8.2 Marker carrier



**Item No.: 2009-198**

Adaptor; gray

### 1.2.8.3 Marking strip



**Item No.: 2009-110**

Marking strips; for Smart Printer; on reel; not stretchable; plain; snap-on type; white

### 1.2.9 Protective warning marker

#### 1.2.9.1 Cover



**Item No.: 2006-115**

Protective warning marker; for 5 terminal blocks; with high-voltage symbol, black; yellow

### 1.2.10 Screwless end stop

#### 1.2.10.1 Mounting accessories



**Item No.: 249-117**

Screwless end stop; 10 mm wide; for DIN-rail 35 x 15 and 35 x 7.5; gray



**Item No.: 249-116**

Screwless end stop; 6 mm wide; for DIN-rail 35 x 15 and 35 x 7.5; gray



## 1.2.11 Test and measurement

### 1.2.11.1 Testing accessories



Item No.: 210-136

Test plug; 2 mm Ø; with 500 mm cable; red

## 1.2.12 Tool

### 1.2.12.1 Operating tool



Item No.: 210-721

Operating tool; Blade: 5.5 x 0.8 mm; with a partially insulated shaft; multicoloured

## Installation Notes

### Conductor termination

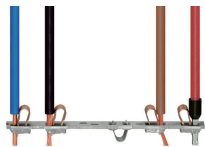

All conductor types at a glance

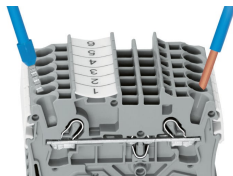

Push-in termination of solid and ferruled conductors

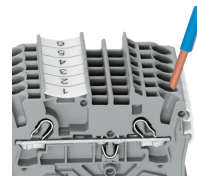

**Inserting a conductor via push-in termination:**  
Solid conductors with cross-sections from either one size above, or up to two sizes below, the rated cross-section can be simply pushed in – no tools needed.

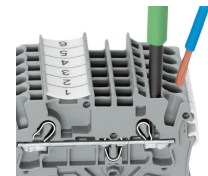

**Inserting a conductor via operating tool:**  
Connecting fine-stranded conductors without ferrules, or small cross-sectional conductors that cannot be pushed in, is performed similarly to the original CAGE CLAMP® – just use an operating tool.  
**Advantage:**  
To open the clamp, the operating tool is inserted vertically. The conductor entry is less than 15 degrees for easier wiring.

### Commoning

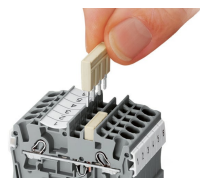

Insert push-in type jumper bar and push down until it hits backstop.

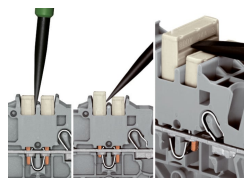

**Removing a push-in type jumper bar:**  
Insert the operating tool between the jumper and partition wall of the dual jumper slots, then lift up the jumper.  
Place the operating tool in the center of jumpers for up to five contacts (see above), or alternately on both sides for jumpers with more than five contacts.

