

Productinformatieblad

Specificaties



Harmony - Tijdrelais - Multifunctioneel - 12-240V AC/DC - 2CO

RE22R2MMW

EAN Code: 3606480676574

Prijs: 84,00 EUR

Hoofd

range of product	Harmony-timerrelais
digitaal uitgangstype	Relais
product of component type	Modulaire tijdrelais
device short name	RE22
nominale uitgangsstroom	8 A

Complementair

type en samenstelling contact	1 C/O tijdcontact 1 C/O tijd- of onmiddellijk contact
type tijdsvertraging	Vertraging bij inschakeling Vertraging bij in- en uitschakelen Print gegevens Vertraging bij uitschakeling Symmetrisch knipperend
tijdsvertraging bereik	0.1...1 s 6...60 s 1...10 h 1...10 min 1...10 s 10...100 h 6...60 min
besturingstype	Draaiknop voorpaneel
Us nominale voedingsspanning	12...240 V AC/DC
spanningsbereik	0,85...1,1 Us
voedingsfrequentie	50...60 Hz +/- 5 %
aansluitingen - aansluitklemmen	Schroefklemmen, 2 x 1,5 mm ² met kabeluiteinde Schroefklemmen, 2 x 2,5 mm ² zonder kabeluiteinde
aanspanmoment	0,6...1 N.m In overeenstemming met IEC 60947-1
materiaal behuizing	Polycarbonaat
herhalingsnauwkeurigheid	+/-0.5% In overeenstemming met IEC 61812-1
temperatuurafwijking	+/- 0,05 %/°C
spanningsverloop	+/- 0,2 %/V
instelling nauwkeurigheid tijdsvertraging	+/- 10% van totaal om 25 °C In overeenstemming met IEC 61812-1

De weergegeven prijs is de adviesprijs in euro excl. BTW. Deze kan onderhevig zijn aan korting. Neem contact op met uw lokale distributeur of detailhandel voor de daadwerkelijke prijs

Time delay type	Vertraging bij inschakeling - A- Vertragingrelais bij inschakeling Vertraging bij in- en uitschakelen - Ac - Vertraginginschakeling en uitschakelrelais m/ controlesignaal Vertraging bij inschakeling - Bij- Vertragingrelais bij inschakeling vermogen m/ pauze/optelling (Y1) Print gegevens - B- Eén intervalrelais met controlesignaal Print gegevens - Bw- Dubbel intervalrelais m/ besturingssignaal Vertraging bij uitschakeling - C- Uit-vertragingrelais m/ controlesignaal Symmetrisch knipperend - D- Symmetrisch knipperend relais (start pulse-off) Symmetrisch knipperend - Di- Symmetrisch knipperend relais (start puls-on) Print gegevens - H- Intervalrelais Print gegevens - Ht- Intervalrelais m/ pauze/optelling (Y1)
impulsduur	30 ms 100 ms onderbelasting
isolatieweerstand	100 MOhm om 500 V DC In overeenstemming met IEC 60664-1
Hersteltijd	120 ms bij ontkrachtiging
immuniteit voor micro-onderbrekingen	10 ms
maximaal energieverbruik in VA	3 VA om 240 V AC
maximaal energieverbruik in W	1,5 W om 240 V DC
uitschakelvermogen	2000 VA
minimale schakelstroom	10 mA om 5 V
maximale schakelstroom	8 A
maximale schakelspanning	250 V
elektrische duurzaamheid	100000 cycles voor resistief belasting, 8 A om 250 V, AC
mechanical durability	10000000 cycles
Uimp toegekende schokgolfspanning	5 kV voor 1,2...50 µs In overeenstemming met IEC 60664-1 5 kV In overeenstemming met IEC 61812-1
Vertraging bij inschakeling	100 ms
betrouwbaarheidsgegevens veiligheid	B10d = 230000 MTTFd = 251.1 jaar
montagepositie	Eender welke positie in verhouding tot het normale verticale montagevlak
montagesteun	35mm DIN rail In overeenstemming met IEC 60715
status LED	Groen LED (Flitsend) voor timing in progress Groen LED (Vast) voor stroom AAN Geel LED voor relais bekrachtigd
functie beschikbaar	A- Vertragingrelais bij inschakeling-2 C/O Ac - Vertraginginschakeling en uitschakelrelais m/ controlesignaal-2 C/O Bij- Vertragingrelais bij inschakeling vermogen m/ pauze/optelling (Y1)-2 C/O B- Eén intervalrelais met controlesignaal-2 C/O Bw- Dubbel intervalrelais m/ besturingssignaal-2 C/O C- Uit-vertragingrelais m/ controlesignaal-2 C/O D- Symmetrisch knipperend relais (start pulse-off)-2 C/O Di- Symmetrisch knipperend relais (start puls-on)-2 C/O H- Intervalrelais-2 C/O Ht- Intervalrelais m/ pauze/optelling (Y1)-2 C/O
breedte	22,5 mm
gewicht product	0,093 kg
control type	Met testknop
Aantal functies	10

Omgeving

doorslagvastheid	2,5 kV voor 1 mA/1 minuut om 50 Hz In overeenstemming met IEC 61812-1
-------------------------	---

standards	IEC 61812-1 IEC 61000-6-2 IEC 61000-6-1 IEC 61000-6-4 IEC 61000-6-3
richtlijnen	2004/108/EG - Elektromagnetische compatibiliteit 2006/95/EG - laagspanningsrichtlijn
product certifications	CSA CE cULus GL RCM CCC EAC
omgevingstemperatuur voor werking	-20...60 °C
ambient air temperature for storage	-30...60 °C
IP beschermingsgraad	Behuizing: IP40 In overeenstemming met IEC 60529 Klemmenblok: IP20 In overeenstemming met IEC 60529 Voorkant: IP40 In overeenstemming met IEC 60529
trilling bestendigheid	20 m/s ² (f= 10...150 Hz) In overeenstemming met IEC 60068-2-6
schokbestendigheid	15 gn voor 11 ms In overeenstemming met IEC 60068-2-27
relatieve vochtigheid	93 %, zonder condensatie In overeenstemming met IEC 60068-2-30
elektromagnetische compatibiliteit	Elektrostatische ontlading immuniteitstest - testniveau: 6 kV niveau 3 (contactontlading) In overeenstemming met IEC 61000-4-2 Elektrostatische ontlading immuniteitstest - testniveau: 8 kV niveau 3 (luchtontlading) In overeenstemming met IEC 61000-4-2 Fast transients immunity test - testniveau: 1 kV niveau 3 (capacitieve verbindingsclip) In overeenstemming met IEC 61000-4-4 Fast transients immunity test - testniveau: 2 kV niveau 3 (direct contact) In overeenstemming met IEC 61000-4-4 Immuniteitstest overspanning - testniveau: 1 kV niveau 3 (differentieelmodus) In overeenstemming met IEC 61000-4-5 Immuniteitstest overspanning - testniveau: 2 kV niveau 3 (gewone modus) In overeenstemming met IEC 61000-4-5 Radiofrequent elektromagnetisch veld immuniteitstest - testniveau: 10 V niveau 3 (0,15...80 MHz) In overeenstemming met IEC 61000-4-6 Elektromagnetisch veld immuniteitstest - testniveau: 10 V/m niveau 3 (80 MHz...1 GHz) In overeenstemming met IEC 61000-4-3 Bestand tegen micro-onderbrekingen en spanningsverlies - testniveau: 30 % (500 ms) In overeenstemming met IEC 61000-4-11 Bestand tegen micro-onderbrekingen en spanningsverlies - testniveau: 100 % (20 ms) In overeenstemming met IEC 61000-4-11 Geleide en uitgestraalde emissies klasse B In overeenstemming met EN 55022

Verpakkingseenheid

Eenheidstype van verpakking 1	PCE
Aantal eenheden in verpakking 1	1
verpakking 1 hoogte	3,000 cm
verpakking 1 breedte	8,600 cm
verpakking 1 lengte	9,900 cm
verpakking_1_gewicht	108,000 g
Eenheidstype van verpakking 2	S02
Aantal eenheden in verpakking 2	40
verpakking 2 hoogte	15,000 cm
verpakking 2 breedte	30,000 cm
verpakking 2 lengte	40,000 cm
verpakking 2 gewicht	4,800 kg

contractuele waarborg

Garantie (in maanden)

18

Schneider Electric wil tegen 2050 de Net Zero-status hebben bereikt via partnerschappen in de toeleveringsketen, materialen met een lagere impact en circulariteit via onze doorlopende campagne "Use Better, Use Longer, Use Again" om de levensduur van producten en de recycleerbaarheid te verlengen.

[Uitleg van Environmental Data >](#)

[Hoe evalueren we de duurzaamheid van producten? >](#)

Milieuoetafdruk

Totale levenscyclus ecologische voetafdruk	66 kg CO2 eq.
Koolstofvoetafdruk van de fabricagefase [A1–A3]	2 kg CO2 eq.
Koolstofvoetafdruk van de distributiefase [A4]	0 kg CO2 eq.
Koolstofvoetafdruk van de installatiefase [A5]	0 kg CO2 eq.
Koolstofvoetafdruk van de gebruiksfase [B2, B3, B4, B6]	64 kg CO2 eq.
Koolstofvoetafdruk van de einde-levensfase [C1–C4]	0.1 kg CO2 eq.
Milieu Profiel	Milieuprofiel van het product

Use Better

Materialen en verpakking

Pakket met gerecycleerd karton	Ja
Verpakkingen zonder kunststof	Ja
SCIP-nummer	7bdc2711-0ad2-427c-8ece-532c5e9f09d7
RoHS-richtlijn van de EU	Conform door vrijstelling
REACH-verordening	Referentie bevat zorgwekkende stoffen (SVHC) boven drempelwaarde

Use Longer

Levensduurverlenging

Reparatie	Nee
-----------	-----

Use Again

Herverpakken en herfabriceren

Percentage mogelijke recycleerbaarheid	18
Circulair Profiel	Informatie over einde levensduur
Terugname	Ja

Dimensions Drawings

Dimensions

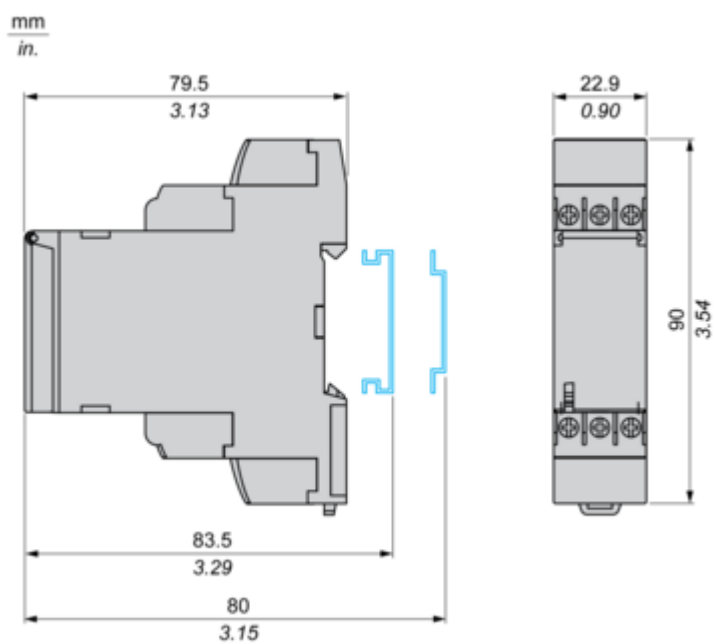

Connections and Schema

Internal Wiring Diagram

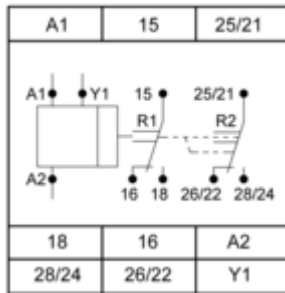

Wiring Diagram

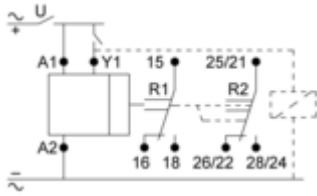

Technical Description

Function A : Power on Delay Relay

Description

The timing period T begins on energization. After timing, the output(s) relay close(s).

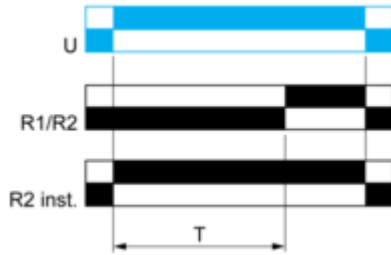

2 timed outputs (R1/R2) or 1 timed output (R1) and 1 instantaneous output (R2 inst.)

Function Ac : On- and Off-Delay Relay with Control Signal

Description

After power-up, closing of the control contact Y1 causes the timing period T to start (timing can be interrupted by operating the Gate control contact G). At the end of this timing period, the relay closes.

When control contact Y1 re-opens, the timing T starts. At the end of this timing period T

At the end of this timing period T, the output reverts to its initial position (timing can be interrupted by operating the Gate control contact G).

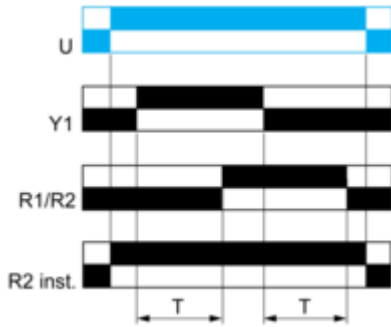

2 timed outputs (R1/R2) or 1 timed output (R1) and 1 instantaneous output (R2 inst.)

Function At : Power on Delay Relay (Summation) with Control Signal

Description

After power-up, the first opening of control contact Y1 starts the timing. Timing can be interrupted each time control contact closes. When the cumulative total of time periods elapsed reaches the pre-set value T, the output relay closes.

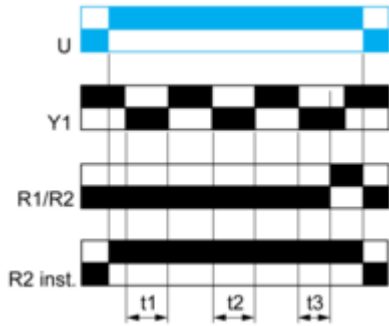

$T = t1+t2+t3$

Function B : Interval Relay with Control Signal

Description

After power-up, pulsing or maintaining control contact Y1 starts the timing T. The output relay closes for the duration of the timing period T then reverts to its initial state.

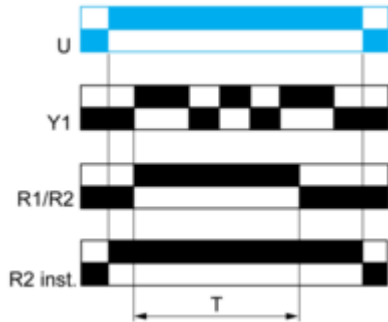

Function Bw : Double Interval Relay with Control Signal

Description

On closing and opening of control contact Y1, the output relay closes for the duration of the timing period T.

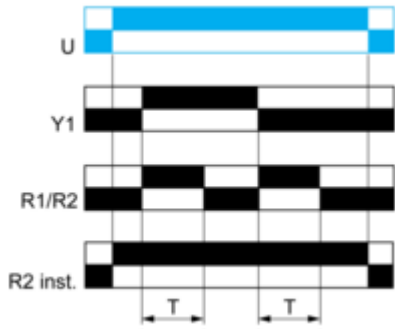

Function C : Off-Delay Relay with Control Signal

Description

After power-up and closing of the control contact Y1, the output relay closes. When control contact Y1 re-opens, timing T starts. At the end of the timing period, the output(s) relay revert(s) to its/their initial state.

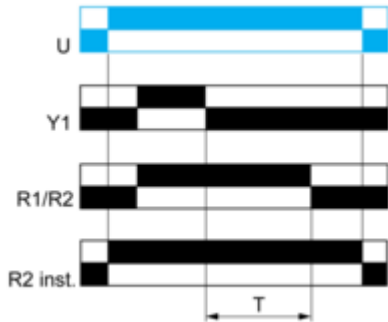

2 timed outputs (R1/R2) or 1 timed output (R1) and 1 instantaneous output (R2 inst.)

Function D : Symmetrical Flasher Relay (Starting Pulse Off)

Description

Repetitive cycle with two timing periods T of equal duration, with output(s) relay changing state at the end of each timing period T.

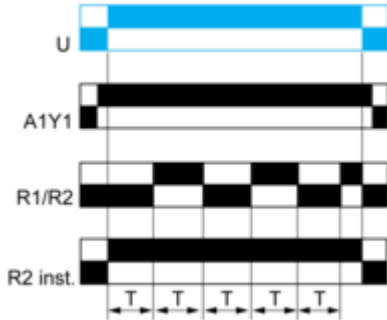

Before power-up Y1 should be permanently connected to A1.
2 timed outputs (R1/R2) or 1 timed output (R1) and 1 instantaneous output (R2 inst.)

Function D : Symmetrical Flasher Relay (Starting Pulse On)

Description

Repetitive cycle with two timing periods T of equal duration, with output(s) relay changing state at the end of each timing period T.

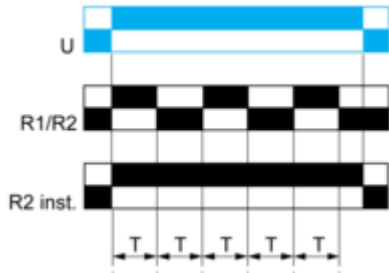

2 timed outputs (R1/R2) or 1 timed output (R1) and 1 instantaneous output (R2 inst.)

Function H : Interval Relay

Description

On energization of the relay, timing period T starts and the output(s) relay close(s). At the end of the timing period T, the output(s) relay revert(s) to its/their initial state

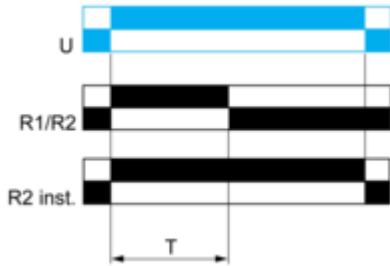

2 timed outputs (R1/R2) or 1 timed output (R1) and 1 instantaneous output (R2 inst.)

Legend

- Relay de-energised
- Relay energised
- Output open
- Output closed

Y1 :	Control contact
R1/R2 :	2 timed outputs
R2 inst. :	The second output is instantaneous if the right position is selected
T :	Timing period
U :	Supply

Function Ht: Interval Relay & With Pause / Summation Control

Description

On energisation of power supply, output(s) R close(s) and timing period T starts.

The timing can be interrupted / paused each time X1 energizes.

When the cumulative total of time periods elapsed reaches the pre-set value T, the output(s) R revert(s) to its/their initial state Reenergization of X1 will also cause output(s) R close(s) if the time has elapsed and restart the same operation as described at the beginning.

Except for RE17*, RE22R2MMW, RENF22R2MMW, RE22R2MMU and RE22R2MJU, timing can be interrupted / paused each time Y1 energizes.

The second output (R2) can be either timed (when set to "TIMED" or instantaneous (when set to "INST").

Function: 1 Output

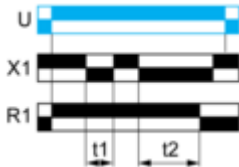

$T = t1 + t2 + \dots$

Function: 2 Outputs

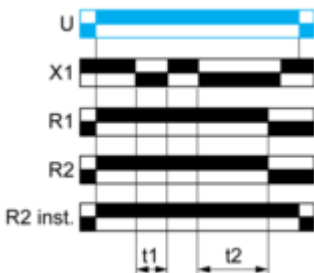

$T = t1 + t2 + \dots$

Function: 1 Output with Retrigger / Restart Control

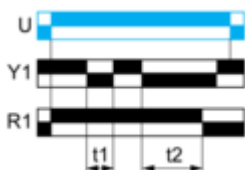

$T = t1 + t2 + \dots$

Function: 2 Outputs with Retrigger / Restart Control

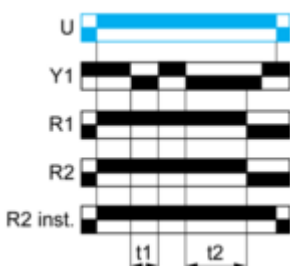

$T = t1 + t2 + \dots$

Technical Illustration

Dimensions

mm
in.

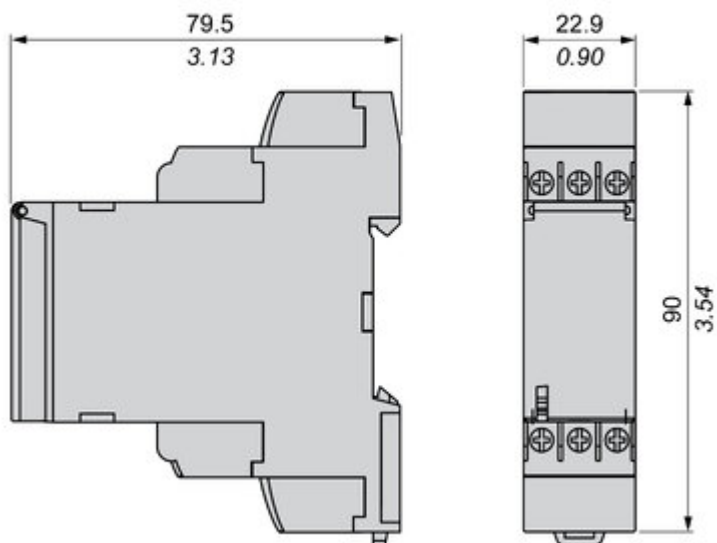

Offer Marketing Illustration

Product benefits / Features

Technical Benefits

Harmony Timer Relay

Flexible choice of screw or spring connection terminals for wiring.

One product reference covering 28 timing functions, 2 outputs, and a wide range of supply voltage 24...240 V AC/DC.

Dust and unintended human intervention avoided thanks to the IP50 lead-sealable settings protection cover.

A Dial-Pointer LED indicator that enhances ease of operation in difficult environments such as dusty or low-light conditions

Different mounting style to meet your preference:
DIN rail mount with product width; 17.5 mm/0.69 in.
22.5 mm/0.88 in.
Plug in mounting with socket



Offer Marketing Illustration

Product benefits / Features



Features

Harmony Timer Relay

- 

"Diagnostic button" to check downstream circuit immediately, shorten the commission and troubleshooting time
- 

Compatible with a wide range of applications including machines, buildings, water segments, and HVAC.
- 

Wide range of time delay for adjustment: from 0.01 s to 999 hrs.
- 

Compliant with IEC 60255-1 standard, and a wide array of product certifications such as UL, CE, CSA, EAC.
- 

Unprecedented accuracy, predictive maintenance, and superior security.

Image of product / Alternate images

Alternative

