















90 17 01 251 00



	Brushed Bronze (PVD)	90 17 01 251 00-42
	Chrome	90 17 01 251 00-00
	Brushed Platinum	90 17 01 251 00-06
	Platinum	90 17 01 251 00-08
	Matte White	90 17 01 251 00-10
	Dark Chrome	90 17 01 251 00-19
	Light Gold (PVD)	90 17 01 251 00-26
	Brushed Light Gold (PVD)	90 17 01 251 00-27
	Brushed Durabronze (23kt Gold)	90 17 01 251 00-28
	Matte Black	90 17 01 251 00-33
	Brushed Champagne (22kt Gold)	90 17 01 251 00-46
	Champagne (22kt Gold)	90 17 01 251 00-47
	Brushed Chrome	90 17 01 251 00-93
	Brushed Dark Platinum	90 17 01 251 00-99



Connection 87 x 132 x 199 mm - Brushed Bronze (PVD)

SPARE PARTS

90 17 01 251 00



Connection 87 x 132 x 199 mm - Brushed Bronze (PVD)

SPARE PARTS

90 17 01 251 00

90 17 01 251 00

Parts for other finishes can be found here: [Chrome](#)

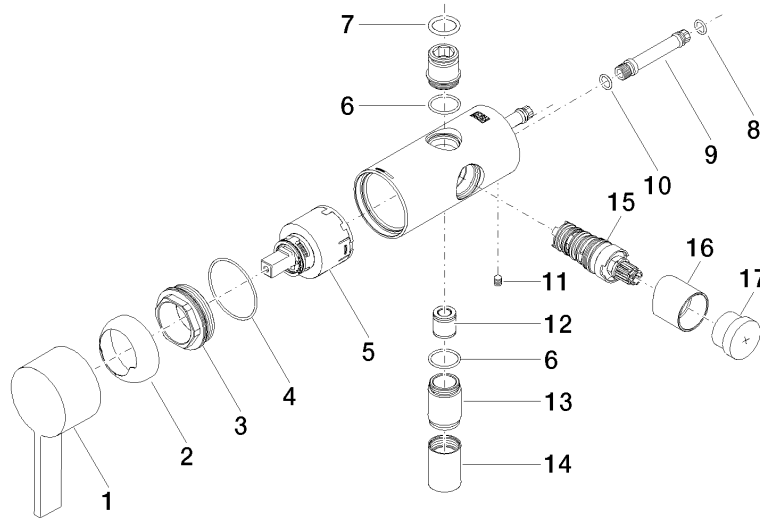

Spare parts list

No.	Item Number	Name	Quantity used	Delivery time
10	90 14 10 060 00 90	O-Ring 8,0 x 1,5 mm -	2.00	14
14	90 21 02 069 00-42	Cover/sleeve M20 x 1 - Brushed Bronze (PVD)	1.00	40
5	90 15 05 066 00 90	Cartridge closed Volume and temperature limitation 40 mm -	1.00	14
6	90 14 10 032 00 90	O-Ring 18,1 x 1,6 mm -	2.00	14
4	09 14 10 037 90	O-Ring 42,0 x 1,5 . mm -	1.00	14
1	90 20 97 065 00-42	handle	1.00	40
12	90 23 01 040 00 90	Back-flow preventer Check valve cartridge, DW15 -	1.00	14
13	09 24 03 115 20-42	Nipple Ø 22 x 33 mm - Brushed Bronze (PVD)	1.00	82
11	09 31 11 004 90	Mounting Threaded pin with hexagon socket M5 x 8 mm	1.00	-
Spare part can no longer be ordered, please order the replacement item				
0431110040090		Mounting -		
2	09 28 30 036-42	Cover Ø 46 x 18 mm - Brushed Bronze (PVD)	1.00	40
15	90 21 34 086 00 90	Diverter for shower pipe Pull diverter 98 x 64 x 64 mm -	1.00	14
7	09 14 10 022 90	O-Ring EPDM 70 16,0 x 2,5 mm -	1.00	14
17	09 26 01 076-42	handle	1.00	82
16	09 31 09 145-42	sleeve	1.00	82
8	09 14 10 061 90	O-Ring EPDM 70 7,5 x 1,52 mm -	2.00	14
3	09 24 04 298 90	Mounting Ø 42 x 17 mm -	1.00	14
9	09 18 40 230 90	Connection 62 x 11 x 11 mm -	2.00	14