

## Data Sheet | Item Number: 790-310

Busbar carrier; for busbars Cu 10 mm x 3 mm; both sides, straight; for DIN 35 rail; silver-colored

<https://www.wago.com/790-310>



Color: ■ silver-colored

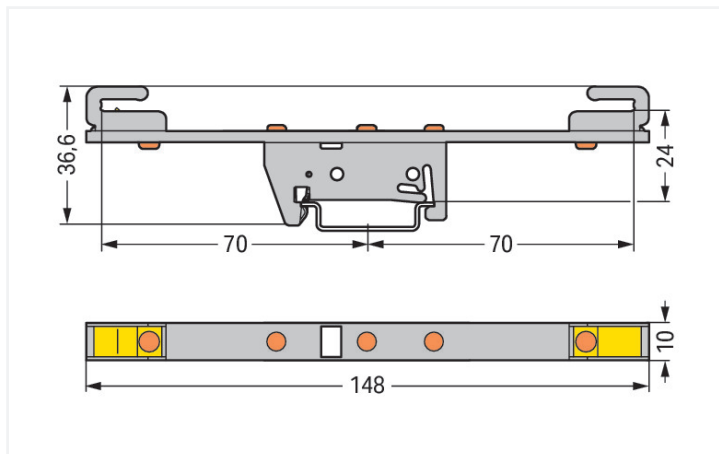

Dimensions in mm

### Material data

Color	silver-colored
Fire load	0 MJ
Weight	58.8 g

### Commercial data

Product Group	2 (Terminal Block Accessories)
PU (SPU)	10 pcs
Packaging type	Box
Country of origin	DE
GTIN	4045454897864
Customs tariff number	85389099990

### Product Classification

UNSPSC	39121613
eCl@ss 10.0	27-40-06-07
eCl@ss 9.0	27-40-06-07
ETIM 9.0	EC001166
ETIM 10.0	EC001166
ECCN	NO US CLASSIFICATION

**Environmental Product Compliance**

RoHS Compliance Status	Compliant, No Exemption
------------------------	-------------------------

Processing temperature (min.)	-35 °C
Processing temperature (max.)	85 °C
Processing temperature	-35 ... +85 °C
Continuous operating temperature from	-60 °C
Continuous operating temperature up to	105 °C
Continuous operating temperature	-60 ... +105 °C

**Downloads**

**Environmental Product Compliance**

**Compliance Search**

Environmental Product Compliance 790-310	<a href="#">↓</a>
--	-------------------

**Documentation**

**Bid Text**

790-310	19.02.2019	xml 2.67 KB	<a href="#">↓</a>
790-310	28.11.2018	doc 23.50 KB	<a href="#">↓</a>

**CAD/CAE-Data**

**CAD data**

2D/3D Models 790-310	<a href="#">↓</a>
----------------------	-------------------

**CAE data**

EPLAN Data Portal 790-310	<a href="#">↓</a>
WSCAD Universe 790-310	<a href="#">↓</a>
ZUKEN Portal 790-310	<a href="#">↓</a>

## 1 Compatible Products

### 1.1 Optional Accessories

#### 1.1.1 N-busbar

##### 1.1.1.1 Busbar



**Item No.: 210-133**

Busbar; tin-plated; 1000 mm long; Cu 10 mm x 3 mm; white

##### 1.1.1.2 Mounting accessories



**Item No.: 790-134**

Busbar; tin-plated; 50 mm long; Cu 10 mm x 3 mm; silver-colored