

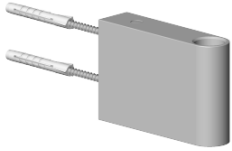















Holder for rain showers 140 x 95 x 90 mm - Brushed Bronze (PVD)

SPARE PARTS

90 17 11 150 00 Product version from 4/1/2025



	Brushed Bronze (PVD)	90 17 11 150 00-42
	Chrome	90 17 11 150 00-00
	Brushed Platinum	90 17 11 150 00-06
	Platinum	90 17 11 150 00-08
	Matte White	90 17 11 150 00-10
	Dark Chrome	90 17 11 150 00-19
	Light Gold (PVD)	90 17 11 150 00-26
	Brushed Light Gold (PVD)	90 17 11 150 00-27
	Brushed Durabronze (23kt Gold)	90 17 11 150 00-28
	Matte Black	90 17 11 150 00-33
	Brushed Dark Brass (PVD)	90 17 11 150 00-39
	Brushed Champagne (22kt Gold)	90 17 11 150 00-46
	Champagne (22kt Gold)	90 17 11 150 00-47
	Brushed Chrome	90 17 11 150 00-93
	Brushed Dark Platinum	90 17 11 150 00-99



Holder for rain showers 140 x 95 x 90 mm - Brushed Bronze (PVD)

SPARE PARTS

90 17 11 150 00 Product version from 4/1/2025



Holder for rain showers 140 x 95 x 90 mm - Brushed Bronze (PVD)

SPARE PARTS

90 17 11 150 00 Product version from 4/1/2025

90 17 11 150 00 Product version from 4/1/2025

Parts for other finishes can be found here: [Chrome](#)

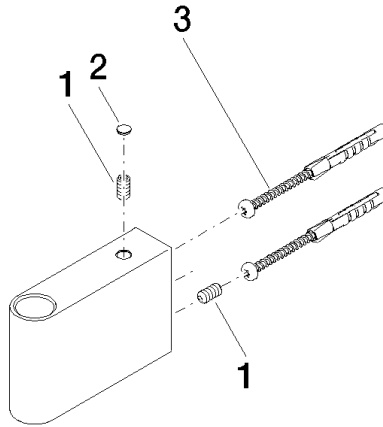

Spare parts list

No.	Item Number	Name	Quantity used	Delivery time
2	90 31 20 087 00-42	Plug with O-ring Ø 7 x 2,1 mm - Brushed Bronze (PVD)	1.00	40
1	09 31 11 211 90	Mounting Threaded pin with hexagon socket with cup point M6 x 12 mm -	2.00	14
3	05 30 31 025 00 90	Mounting Bolt Round head 4,5 x 60 mm -	2.00	14