



Electric Vehicle charging management infrastructure

EcoStruxure™ EV Charging Expert



Life Is On

Schneider
Electric

EcoStruxure™ EV Charging Expert

Monitor, control and maximize EV charging based on the real-time available power in your building.



Peace of mind
Maximized continuity of service all while providing fair and controlled EV charging services



Cost effective
Minimum infrastructure upgrade
On-peak/off-peak tariff settings



Connected offer
Connection to embedded dashboard for supervision and control, to a CPO backend or to BMS



Upgradeable and scalable
Upgrade to a higher level software license to adapt to your evolving EV charging needs



Easy installation & commissioning
With a configuration assistant and features such as automatic scan of chargers



Easy operation
With user access management and charging sessions data registering



Easy maintenance
With remote charging station control and logs data registering

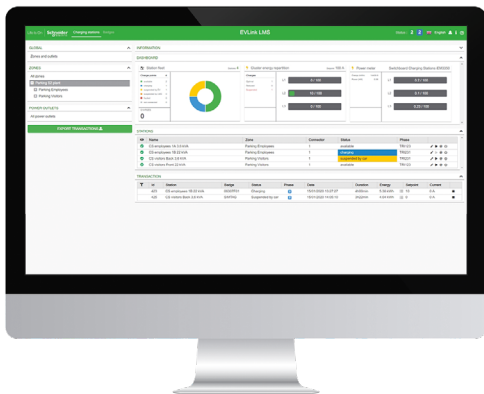

EcoStruxure EV Charging Expert is the perfect solution for fleets, private company parking or condominiums to enjoy EV charging services all while ensuring an optimized use of energy and a cost-effective and sustainable operation.

EcoStruxure EV Charging Expert is a Solar Impulse Efficient solution.



Find out more here

Energy management

How to optimize the impact of consumption of EV charging infrastructure on an electrical installation

> The problem

Initial situation

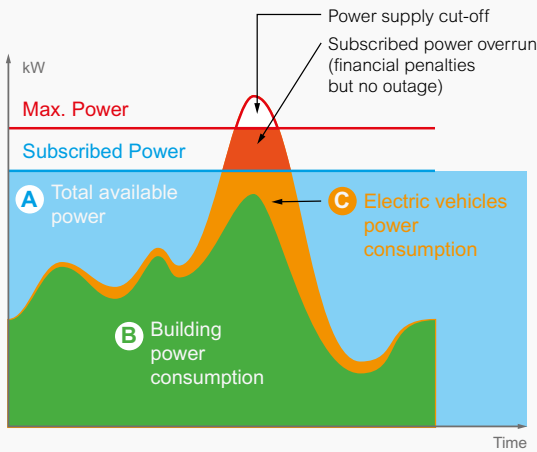

The installation of charging stations in an existing electrical installation can have a significant impact due to the power level required by electric vehicles to charge.

> Solution without energy management

Increase of subscribed power

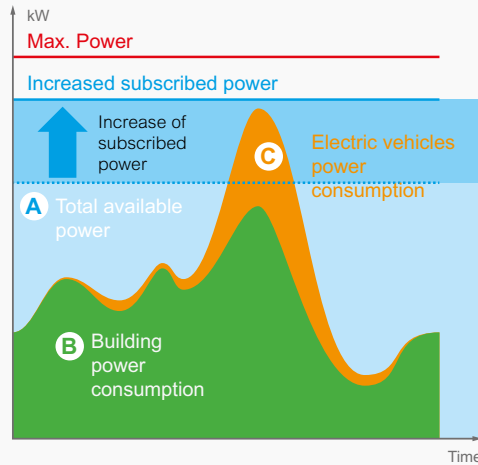

This solution consists of increasing the power subscribed to the energy supplier to maintain the same consumption model. It implies an increase in the cost of the subscription and does not guarantee that the trigger threshold will never be exceeded. Thus the continuity of service of the building is not guaranteed.



Energy management: why do it?

- Avoids facility disruption, causing operating losses
- Reduces power and electrical infrastructure costs
- Makes operations more efficient
- Increases driver satisfaction.



Energy management Cont.

> Schneider Electric solutions

Static energy management

Dynamic energy management

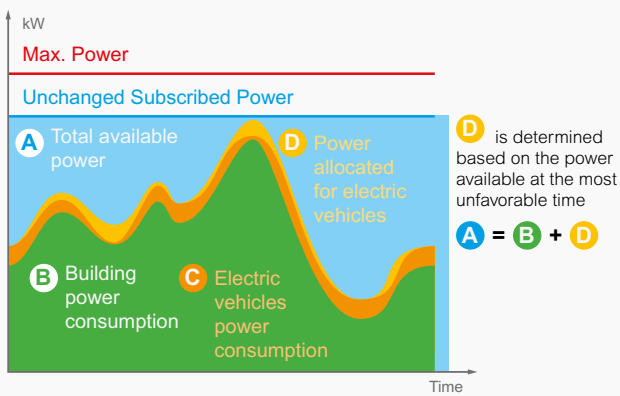

Setpoint "D" is fixed. The power is distributed between all connected vehicles.

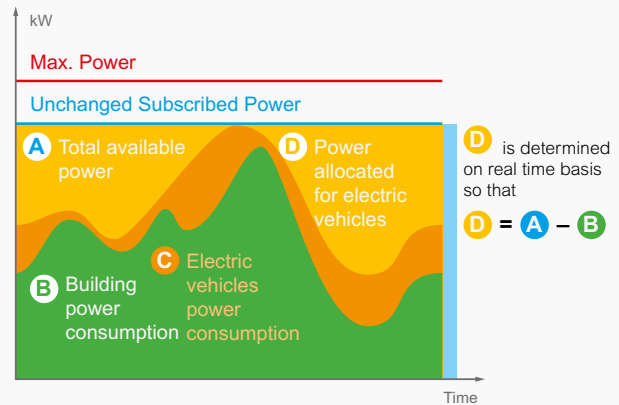

Setpoint "D" is adjusted in real time according to the consumption of the rest of loads in the building, to maximize the power allocated to charging electric vehicles.

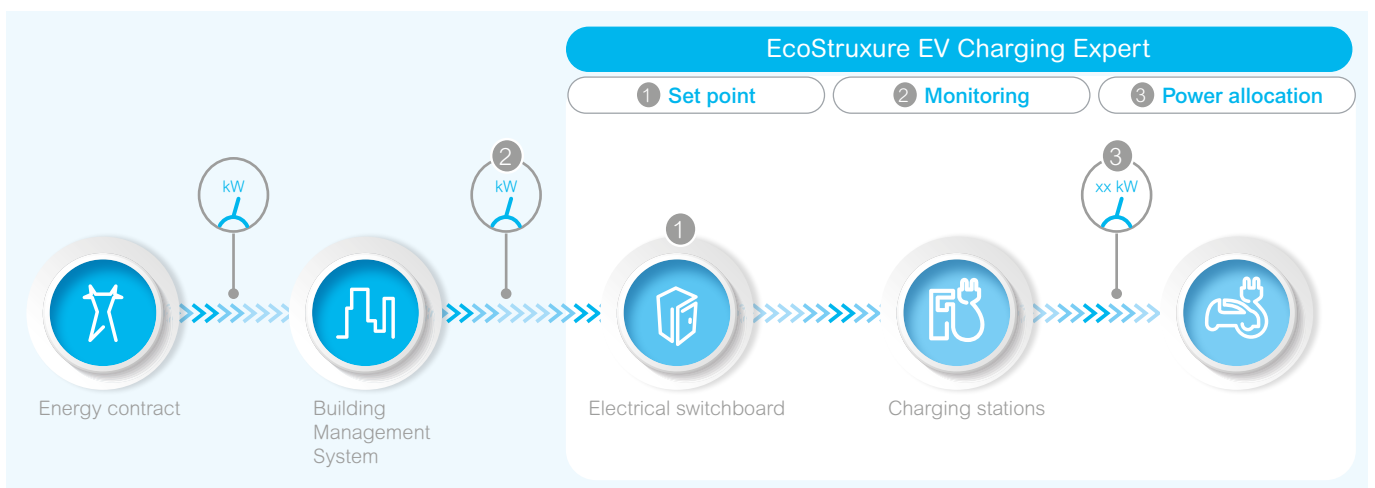

- 1 Defining maximum power with a dynamic or static current setpoint
- 2 Metering the facility and charging stations consumptions
- 3 Algorithms to allocate power to electric vehicles based on real-time needs and availability

How it works



Flexible, simple, cost-effective solution

- From less than 5 to up to 100 charging stations managed
- With an intuitive operation dashboard to manage the entire installation
- Upgradeable from one software license to another to adapt to evolving EV charging needs
- Compatible with open protocol OCPP 1.6 Json, facilitating integration to other systems
- Allows the management of user badges without having to subscribe to a complementary supervision system.



Easy installation, commissioning & maintenance

- Webserver including a configuration assistant that walks the installer through the different steps to configure the system
- Automatic scan and configuration of charging stations, all in parallel to save time
- Easy firmware update, with last firmware release available on se.com
- Registering and download of log records.



Multiple functionalities for efficient operation

- Time-of-use electricity tariff scheduling to limit EV charging when electricity price is high, and to maximize it when it is low (depending on the selected model)
- Privileged (VIP) user badges or charging stations, that will not be load-shed, or just when strictly necessary to ensure building power continuity (depending on the selected model)
- Registering and download of EV charging transactions for analytics, cost allocation or invoicing
- Compatible with CPO backend supervision for user access, billing, and other services if needed
- Offers integration capabilities to Building Management System (BMS) (may require specific development).

Load reduction and load shedding operation

EcoStruxure EV Charging Expert controls the EV charging infrastructure. It allows to limit the instantaneous power drawn by the entire set of connected electric vehicles, and manages the power allocated to each one of them. In real time, it transmits a setpoint to each charging station, which transfers it to the vehicles. In the case that the power demand from the vehicles exceeds the maximum setpoint, EcoStruxure EV Charging Expert applies a reduction on the power available to charge the vehicles in a proportional manner (equal percentage) to all of them.

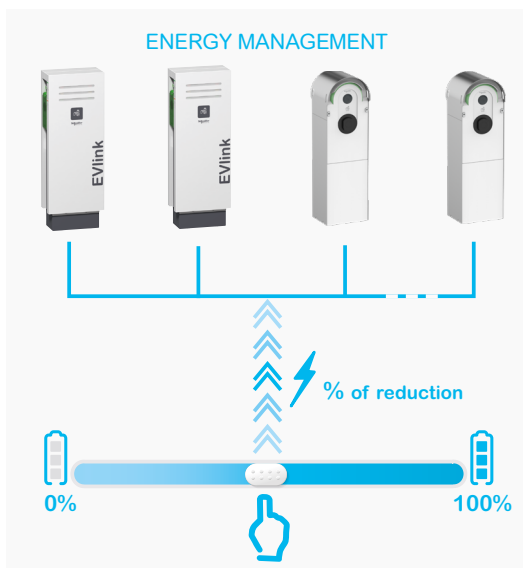

When the load shedding is triggered, the algorithm allows to distribute the available energy according to 2 strategies (depending on the settings):

- **Based on the energy already consumed:** the system suspends the charging of the vehicles that have obtained the higher amount of kWh since the start of their charging, favoring new vehicles
- **Based on the connection time:** the system suspends the charging of the vehicles with the longest charging time favoring those last arrived.

In both cases, the system rechecks and updates the situation every 15 minutes.

Features

EcoStruxure EV Charging Expert references

		EcoStruxure EV Charging Expert with Static mode (dynamic load management with STATIC current setpoint)		EcoStruxure EV Charging Expert with Dynamic & Static modes (dynamic load management with DYNAMIC current setpoint, or STATIC current setpoint)			
References ⁽¹⁾		HMIBSCEA53D1ESS	HMIBSCEA53D1ESM	HMIBSCEA53D1EDB	HMIBSCEA53D1EDS	HMIBSCEA53D1EDM	HMIBSCEA53D1EDL
Features							
Capacity	Number of EVlink charging stations	15	50	5	15	50	100
Power management	Dynamic, with a STATIC current setpoint	●	●	●	●	●	●
	Dynamic with a DYNAMIC current setpoint			●	●	●	●
	Time of use/DI		●		●	●	●
Multi zone	Maximum number of zones	1	10	2	2	10	20
	Maximum number of zones levels	1	3	2	2	3	3
Other loads	Power consumption reporting on other feeders		●			●	●
Badge management	VIP privilege user badge		●			●	●
Stations management	VIP privilege charging station		●			●	●

⁽¹⁾ To upgrade from a current commercial reference to a higher-level one, please consult us.

EV Charging Expert UPGRADES Software references

Upgrade from a current CORE to an upper-level one

Reference	Description
EVLMSedb2EDS	Upgrade EV Charging Expert dynamic 5 CS to 15 CS
EVLMSedb2EDM	Upgrade EV Charging Expert dynamic 5 CS to 50 CS
EVLMSedb2EDL	Upgrade EV Charging Expert dynamic 5 CS to 100 CS
EVLMSess2EDS	Upgrade EV Charging Expert 15 CS from static to dynamic
EVLMSess2ESM	Upgrade EV Charging Expert static from 15 CS to 50 CS
EVLMSess2EDM	Upgrade EV Charging Expert from 15 CS static to 50 CS dynamic
EVLMSeds2EDM	Upgrade EV Charging Expert dynamic from 15 CS to 50 CS
EVLMSess2EDL	Upgrade EV Charging Expert from 15 CS static to 100 CS dynamic
EVLMSeds2EDL	Upgrade EV Charging Expert dynamic from 15 CS to 100 CS
EVLMSesm2EDM	Upgrade EV Charging Expert from 50 CS static to 50 CS dynamic
EVLMSesm2EDL	Upgrade EV Charging Expert static 50 CS to dynamic 100 CS
EVLMSedm2EDL	Upgrade EV Charging Expert dynamic from 50 CS to 100 CS

Functions performed by all commercial references of EcoStruxure EV Charging Expert

Access Management	Commissioning	Operation	Connectivity
Add, modify, delete, supervise badges	Commissioning all charging stations directly from EcoStruxure EV Charging Expert	Supervision through real time dashboard and remote actions on charging stations	Connection with CPO supervision (OCPP 1.6 Json)
	Save & restore commissioned configuration	Charge data report export	Connection with EcoStruxure supervision (web services) ⁽¹⁾
		Maintenance report export	Optional: 3G/4G modem
			Commissioning by Ethernet cable

⁽¹⁾ May require specific development

Dimensions

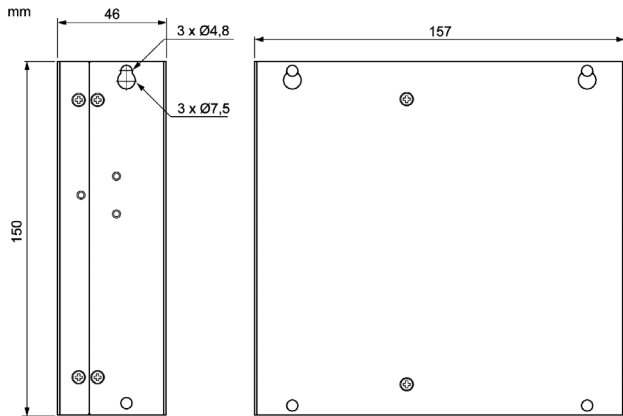

Rear view

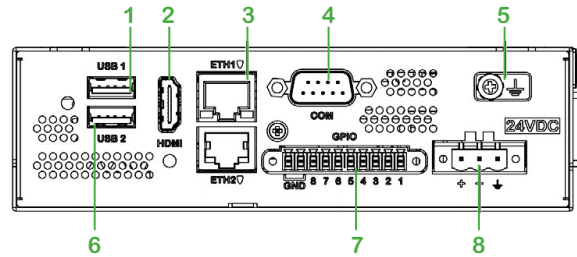

- 1- USB1 (USB 2.0)
- 2- HDMI port
- 3- ETH1 (10/100/1000 Mbits/s)
- 4- COM port RS-232/422/485
- 5- Ground connection pin
- 6- USB2 (USB 2.0)
- 7- GPIO
- 8- DC power connector



Architectures

IT network topologies

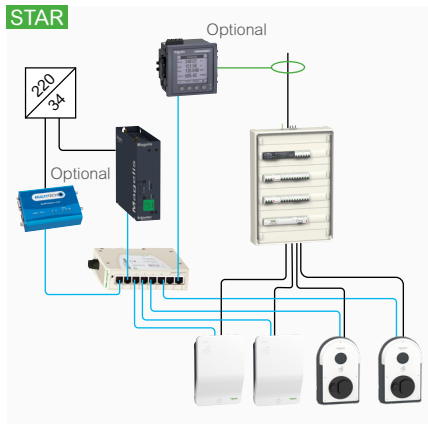

Star connection using basic switch part number TCSEU083FN0. Non manageable

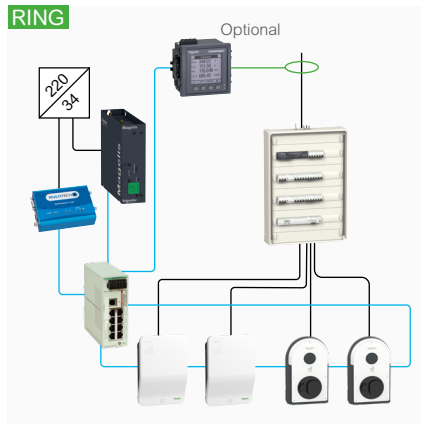

Ring connection with manageable switch part number TCSEBU083F23F0 or TCSELU043F23F0

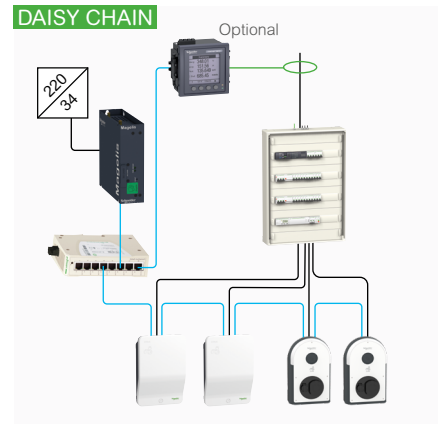

This topology is not recommended since it does not ensure optimum continuity of service

Charging stations and power meters compatibility

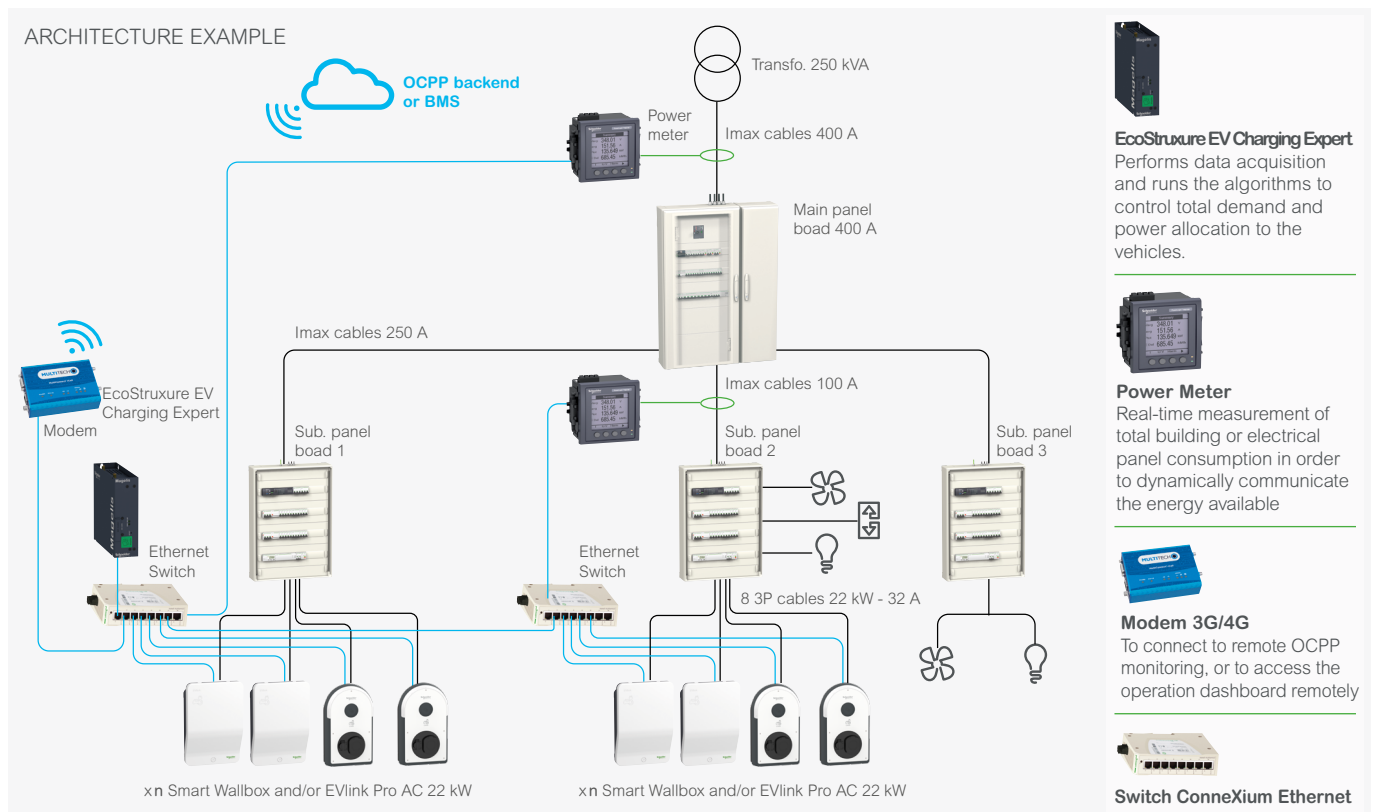
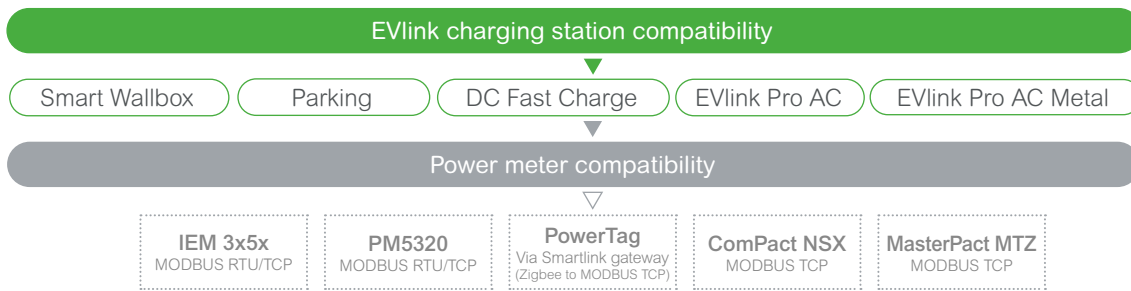

Monitoring: an intuitive user interface

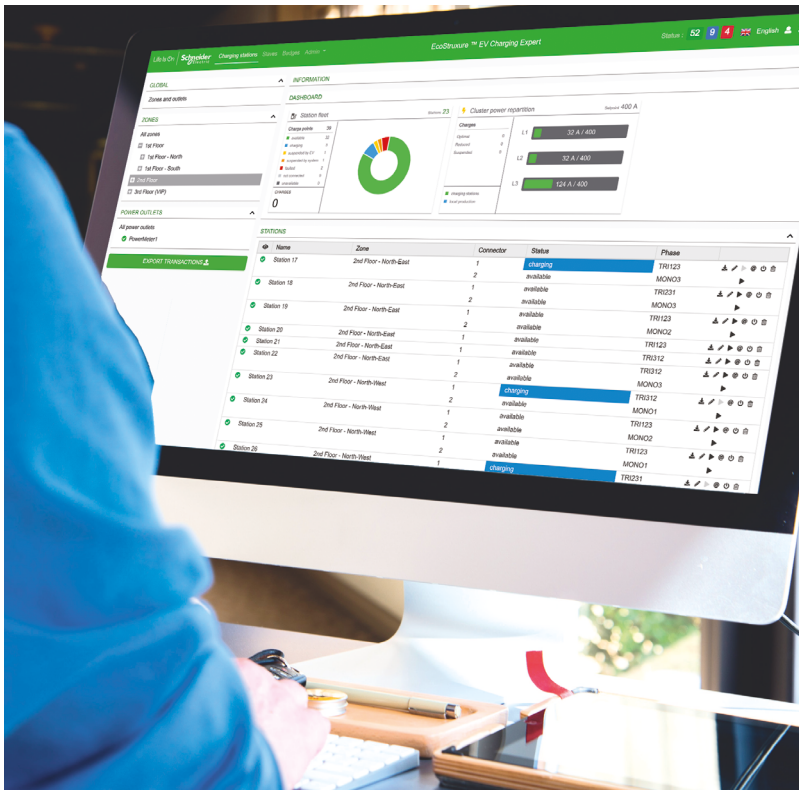

The monitoring is local, with no cloud subscription requested.

EcoStruxure EV Charging Expert centralizes the data from all chargers on an intuitive and ergonomic user interface and allows to:

- Visualize a dashboard showing in real time the status of each charger
- Start/stop a charging session
- Manage badges (local addition, import, export) and user rights
- Monitor and download transactions history per charging station or aggregated for the infrastructure
- Consult and download maintenance data
- Configure the connection to a remote supervision
- Set parameters: Add/Remove chargers, update them and change their configuration
- Save and restore commissioned configuration
- With an administrator profile, access and modify all system settings.

I can have a holistic view of my charging stations, their status, their transactions and I can launch remote actions on each of them

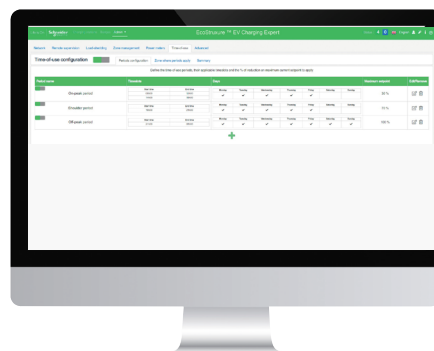
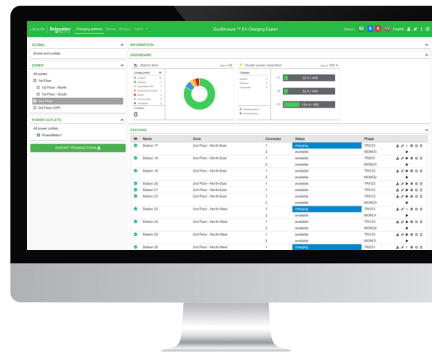

I can limit EV charging when electricity prices are high and maximize it when they are low

Life Is n

Schneider
 **Electric**[™]