











22 513 892 Product version from 6/30/2009 to 5/27/2021



- 165mm projection
- pivotable spout 360°
- circular, air-enriched flow
- height of mixer 295 mm
- height up to aerator 172 mm
- hole diameter 35 mm
- rosette Ø 59 mm
- 2x screw-in M 10 x 1 pressure hose, leak-tested
- max. flow 7 l/min
- lead-free
- This product can help a building meet the requirements of Green Building Rating Systems, e.g. LEED®, BREEAM®, DGNB
- WRAS

Only suitable for basins with an overflow.

	Brushed Dark Platinum	22 513 892-99
	Chrome	22 513 892-00
	Brushed Platinum	22 513 892-06
	Platinum	22 513 892-08
	Dark Chrome	22 513 892-19
	Brushed Durabronze (23kt Gold)	22 513 892-28
	Matte Black	22 513 892-33
	Brushed Gold (PVD)	22 513 892-37
	Brushed Dark Brass (PVD)	22 513 892-39
	Brushed Bronze (PVD)	22 513 892-42
	Brushed Dark Bronze (PVD)	22 513 892-43
	Brushed Champagne (22kt Gold)	22 513 892-46
	Champagne (22kt Gold)	22 513 892-47
	Brushed Chrome	22 513 892-93

22 513 892 Product version from 6/30/2009 to 5/27/2021

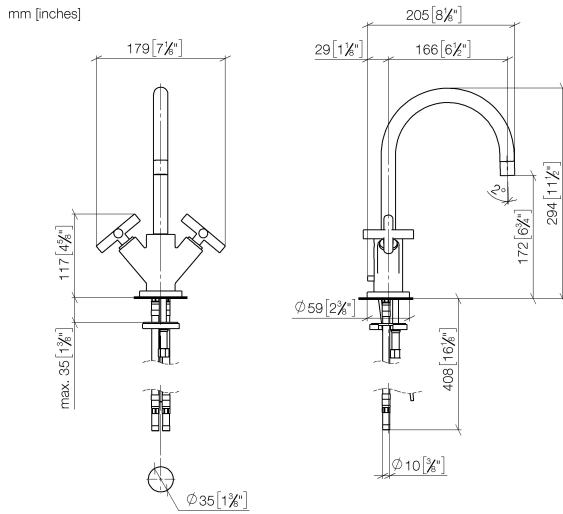

Flow rate chart



Codes & Standards

DIN 4109	EN 200	Executive Order no. 1007	ISO 3822
Scottish Water Byelaws	UK Water Supply Regulations	Ü-Zeichen	VA-Zeichen



# TARA Single-hole basin mixer with pop-up waste - Brushed Dark Platinum

TARA

22 513 892 Product version from 6/30/2009 to 5/27/2021

## Certificates and sustainability

ETA\_18

WRAS\_240702

LGA\_18

GDV\_0400

22 513 892 Product version from 6/30/2009 to 5/27/2021

Parts for other finishes can be found here: [Chrome](#)

