

Walraven RapidRail® Wall Plate

(G1506)

base foot to connect fixing rails

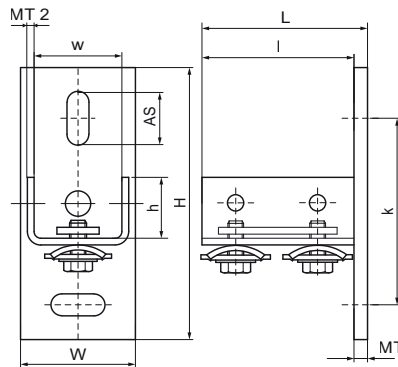
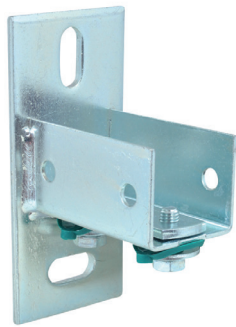

Features & benefits

- flexible base plate to connect fixing rail type 38x40 (WM35) with individual length
- to be used on wall, floor or ceiling
- rail can be fixed with slot downwards or sideways
- anchoring slots at 90° to each other to simplify fixing
- CO₂ welded
- with pre-assembled Walraven RapidRail® slide nuts for a quick fixing, and retains assembly in place before final tightening
- material: metal parts made of steel 1.0332; spring(s) made of POM (polyoxymethylene), green
- zinc plated



Product Number	VVS Number	For Rail Type	Total Height	Total Width	Total Length	Width	Height	Length	Heart To Heart Distance	Anchoring Slot	Fixing Hole	Material Thickness	Material Thickness 2
<i>Reference Letter</i>			<i>H</i>	<i>W</i>	<i>L</i>	<i>w</i>	<i>h</i>	<i>l</i>	<i>k</i>	<i>AS</i>	<i>FH</i>	<i>MT</i>	<i>MT 2</i>
<i>Unit description</i>			<i>mm</i>	<i>mm</i>	<i>mm</i>	<i>mm</i>	<i>mm</i>	<i>mm</i>	<i>mm</i>	<i>mm</i>	<i>mm</i>	<i>mm</i>	<i>mm</i>
6613235	18041180	38x40	133	60	80	45	40	75	93	25x11	9	5.00	2