

Data Sheet | Item Number: 2004-1211/1000-400

Component terminal block; 2-conductor; with diode 1N5408; anode, left side; for DIN-rail 35 x 15 and 35 x 7.5; 4 mm²; Push-in CAGE CLAMP®; gray

<https://www.wago.com/2004-1211/1000-400>

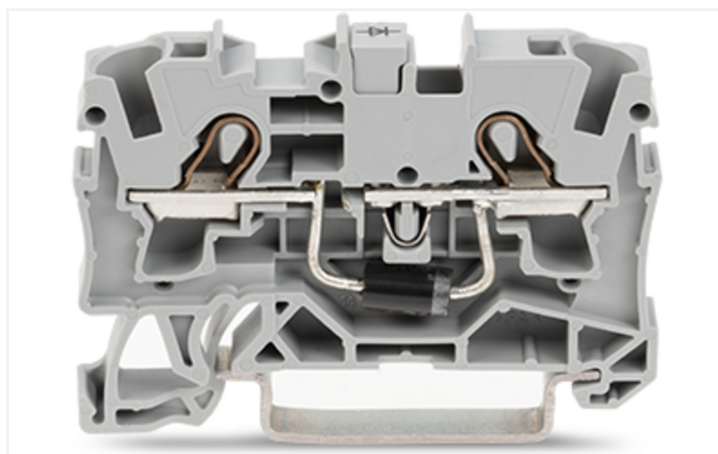
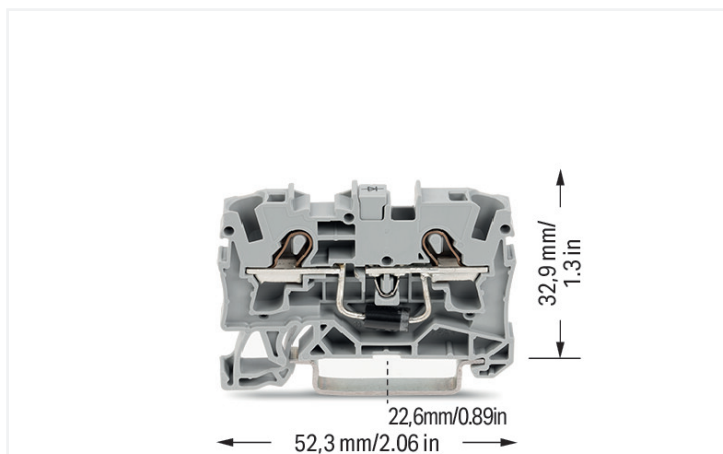

Color: ■ gray

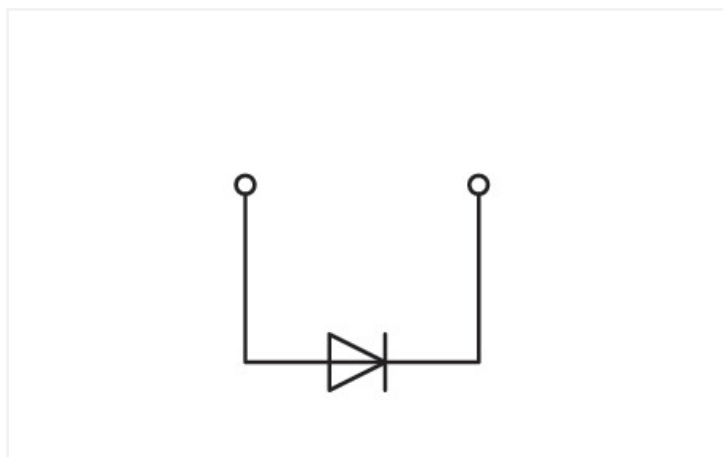

Component terminal block with diode, 2004 Series, gray

Easily, quickly and safely connect conductors with this component terminal block with diode (item number 2004-1211/1000-400). Conductors should only be connected to this component terminal block with diode if their strip length is between 11 and 13 mm. This product features conductor terminals and utilizes Push-in CAGE CLAMP®. Push-in CAGE CLAMP® technology provides a universal connection solution for any type of conductor. It allows both solid and fine-stranded conductors with ferrules to be inserted directly into the clamping point without the need for tools. Depending on the type of conductor, this component terminal block with diode is suitable for conductor cross sections ranging from 0.5 mm² to 6 mm².

Electrical data

General information

Nominal voltage	250 V
Reverse voltage	1000 V
Continuous current (max.)	1.5 A
Number/type of diode/LED	with 1N5408 diode
Wiring direction	Front-entry wiring

Connection data

Clamping units	2
Total number of potentials	1
Number of levels	1

Connection 1

Connection technology	Push-in CAGE CLAMP®
Actuation type	Operating tool
Connectable conductor materials	Copper
Nominal cross-section	4 mm ²
Solid conductor	0.5 ... 6 mm ² / 20 ... 10 AWG
Solid conductor; push-in termination	1.5 ... 6 mm ² / 14 ... 10 AWG
Fine-stranded conductor	0.5 ... 6 mm ² / 20 ... 10 AWG
Fine-stranded conductor; with insulated ferrule	0.5 ... 4 mm ² / 20 ... 12 AWG
Fine-stranded conductor; with ferrule; push-in termination	1.5 ... 4 mm ² / 18 ... 12 AWG
Note (conductor cross-section)	Depending on the conductor characteristic, a conductor with a smaller cross-section can also be inserted via push-in termination.
Strip length	11 ... 13 mm / 0.43 ... 0.51 inches
Wiring direction	Front-entry wiring

Physical data

Width	6.2 mm / 0.244 inches
Height	52.3 mm / 2.059 inches
Depth from upper-edge of DIN-rail	32.9 mm / 1.295 inches

Mechanical data

Mounting type	DIN-35 rail
Marking level	Center/side marking

Material data

Note (material data)	Information on material specifications can be found here
Color	gray
Material group	I
Insulation material (main housing)	Polyamide (PA66)
Flammability class per UL94	V0
Fire load	0.142 MJ
Weight	8.3 g

Environmental requirements

Processing temperature	-35 ... +85 °C	Environmental Testing	
Continuous operating temperature	-60 ... +105 °C		Test specification:
		Test procedure:	DIN EN 61373 (VDE 0115-0106):2011-04
		Spectrum/Mounting location	Service life test, Category 1, Class A/B
		Functional test with noise-like oscillations	Test passed according to Section 8 of the standard
		Frequency	f ₁ = 5 Hz to f ₂ = 150 Hz
		Acceleration	0.101g (highest test level used for all axes)
		Test duration per axis	10 min.

Environmental Testing

Test directions	X, Y and Z axes
Monitoring of contact faults and interruptions	Passed
Voltage drop measurement before and after each axis	Passed
Simulated service life test through increased levels of noise-like oscillations	Test passed according to Section 9 of the standard
Frequency	$f_1 = 5 \text{ Hz}$ to $f_2 = 150 \text{ Hz}$
Acceleration	0.572g (highest test level used for all axes)
Test duration per axis	5 h
Test directions	X, Y and Z axes
Extended testing: Monitoring of contact faults and interruptions	Passed
Extended testing: Voltage drop measurement before and after each axis	Passed
Shock test	Test passed according to Section 10 of the standard
Shock pulse form	Half sine
Acceleration	5g (highest test level used for all axes)
Shock duration	30 ms
Number of shocks (per axis)	3 pos. und 3 neg.
Test directions	X, Y and Z axes
Extended testing: Monitoring of contact faults and interruptions	Passed
Extended testing: Voltage drop measurement before and after each axis	Passed
Vibration and shock stress for rolling stock equipment	Passed

Commercial data

Product Group	22 (TOPJOB S)
PU (SPU)	50 pcs
Packaging type	Box
Country of origin	DE
GTIN	4050821230946
Customs tariff number	85369010000

Product Classification

UNSPSC	39121410
eCl@ss 10.0	27-14-11-27
eCl@ss 9.0	27-14-11-27
ETIM 9.0	EC000903
ETIM 10.0	EC000903
ECCN	NO US CLASSIFICATION

Environmental Product Compliance

RoHS Compliance Status	Compliant, No Exemption
SCIP notification number (Austria)	e3f22a50-d39f-497f-a932-bc73f9be6db9
SCIP notification number (Belgium)	73371259-169a-439b-9275-7ab47b3ae198
SCIP notification number (Bulgaria)	0a9dce73-7d50-4719-9375-947215914a8b
SCIP notification number (Czech Republic)	4ab06938-c53e-4e13-90b8-cb6f8ea0ed88
SCIP notification number (Denmark)	bc6f16b1-1522-4b5a-aeed-4b92cd9a31ee
SCIP notification number (Finland)	dd130040-799f-4119-8767-95f588cad1e1
SCIP notification number (France)	ba3ed1e7-8c9d-4b10-913c-5af205bdb44c
SCIP notification number (Germany)	f6229b2a-3563-4ab5-a74a-122295206c1b
SCIP notification number (Hungary)	495333c4-f0be-4de5-baee-e99cc4392475
SCIP notification number (Italy)	f44f9176-db92-41d0-ba6a-a9b461af582c
SCIP notification number (Netherlands)	3261f29f-501a-402e-a889-a6404adca359
SCIP notification number (Poland)	be6a11d5-7b81-4f82-a17e-bb948f9614d0
SCIP notification number (Romania)	ec9e90e0-c9e4-4b36-901e-2f63f26d0595
SCIP notification number (Sweden)	de798db0-b9f2-430f-b5f8-b862ac21ebd6

Approvals / Certificates

Declarations of conformity and manufacturer's declarations



Approval	Standard	Certificate Name
EU-Declaration of Conformity WAGO GmbH & Co. KG	-	-
Railway WAGO GmbH & Co. KG	-	Railway Ready
UK-Declaration of Conformity WAGO GmbH & Co. KG	-	-

Downloads

Environmental Product Compliance

Compliance Search

Environmental Product Compliance 2004-1211/1000-400	↓
--	---

Documentation

Bid Text

2004-1211/1000-400	07.08.2018	docx 14.91 KB	↓
2004-1211/1000-400	19.02.2019	xml 3.67 KB	↓

CAD/CAE-Data

CAD data

2D/3D Models
2004-1211/1000-400

CAE data

EPLAN Data Portal
2004-1211/1000-400

WSCAD Universe
2004-1211/1000-400

ZUKEN Portal
2004-1211/1000-400

1 Compatible Products

1.1 Required Accessories

1.1.1 End plate

1.1.1.1 End plate



Item No.: 2004-1291

End and intermediate plate; 1 mm thick; gray



Item No.: 2004-1292

End and intermediate plate; 1 mm thick; orange

1.2 Optional Accessories

1.2.1 DIN-rail

1.2.1.1 Mounting accessories



Item No.: 210-196

Aluminum carrier rail; 35 x 8.2 mm; 1.6 mm thick; 2 m long; unslotted; similar to EN 60715; silver-colored



Item No.: 210-198

Copper carrier rail; 35 x 15 mm; 2.3 mm thick; 2 m long; unslotted; according to EN 60715; copper-colored



Item No.: 210-508

Steel carrier rail; 35 x 15 mm; 1.5 mm thick; 2 m long; slotted; galvanized; similar to EN 60715; silver-colored



Item No.: 210-197

Steel carrier rail; 35 x 15 mm; 1.5 mm thick; 2 m long; slotted; similar to EN 60715; silver-colored



Item No.: 210-506

Steel carrier rail; 35 x 15 mm; 1.5 mm thick; 2 m long; unslotted; galvanized; similar to EN 60715; silver-colored



Item No.: 210-114

Steel carrier rail; 35 x 15 mm; 1.5 mm thick; 2 m long; unslotted; similar to EN 60715; silver-colored



Item No.: 210-118

Steel carrier rail; 35 x 15 mm; 2.3 mm thick; 2 m long; unslotted; according to EN 60715; silver-colored



Item No.: 210-115

Steel carrier rail; 35 x 7.5 mm; 1 mm thick; 2 m long; slotted; according to EN 60715; "Hole width 18 mm; silver-colored



Item No.: 210-112

Steel carrier rail; 35 x 7.5 mm; 1 mm thick; 2 m long; slotted; according to EN 60715; "Hole width 25 mm; silver-colored



Item No.: 210-504

Steel carrier rail; 35 x 7.5 mm; 1 mm thick; 2 m long; slotted; galvanized; according to EN 60715; silver-colored



Item No.: 210-113

Steel carrier rail; 35 x 7.5 mm; 1 mm thick; 2 m long; unslotted; according to EN 60715; silver-colored



Item No.: 210-505

Steel carrier rail; 35 x 7.5 mm; 1 mm thick; 2 m long; unslotted; galvanized; according to EN 60715; silver-colored

1.2.2 End plate

1.2.2.1 End plate



Item No.: 2004-1293

Separator plate; 2 mm thick; oversized; gray



Item No.: 2004-1294

Separator plate; 2 mm thick; oversized; orange

1.2.3 Ferrule

1.2.3.1 Ferrule



Item No.: 216-262

Ferrule; Sleeve for 0.75 mm² / 18 AWG; insulated; electro-tin plated; electrolytic copper; gastight crimped; acc. to DIN 46228, Part 4/09.90; gray



Item No.: 216-263

Ferrule; Sleeve for 1 mm² / AWG 18; insulated; electro-tin plated; electrolytic copper; gastight crimped; acc. to DIN 46228, Part 4/09.90; red



Item No.: 216-264

Ferrule; Sleeve for 1.5 mm² / AWG 16; insulated; electro-tin plated; electrolytic copper; gastight crimped; acc. to DIN 46228, Part 4/09.90; black



Item No.: 216-266

Ferrule; Sleeve for 2.5 mm² / AWG 14; insulated; electro-tin plated; electrolytic copper; gastight crimped; acc. to DIN 46228, Part 4/09.90; blue



Item No.: 216-267

Ferrule; Sleeve for 4 mm² / AWG 12; insulated; electro-tin plated; electrolytic copper; gastight crimped; acc. to DIN 46228, Part 4/09.90; gray

1.2.4 Installation

1.2.4.1 Cover



Item No.: 709-156

Cover; Type 3; suitable for cover carrier, type 3; 1 m long; transparent

1.2.4.2 Cover carrier



Item No.: 709-169

Cover carrier; Type 3; incl. fixing/retaining screws and knurled nut; suitable for 279 to 282 and 880 Series rail-mounted terminal blocks; suitable for 264 Series miniature rail-mounted terminal blocks; suitable for 270 Series sensor and actuator terminal blocks; gray

1.2.5 Insulation stop

1.2.5.1 Insulation stop



Item No.: 2004-171

Insulation stop; 0.25 - 0.5 mm²; 5 pieces/strip; light gray

Item No.: 2004-172

Insulation stop; 0.75 - 1 mm²; 5 pieces/strip; dark gray

1.2.6 Jumper

1.2.6.1 Jumper



Item No.: 2004-406/020-000

Delta jumper; insulated; light gray



Item No.: 2004-410

Jumper; 10-way; insulated; light gray



Item No.: 2004-402

Jumper; 2-way; insulated; light gray



Item No.: 2004-403

Jumper; 3-way; insulated; light gray



Item No.: 2004-404

Jumper; 4-way; insulated; light gray



Item No.: 2004-405

Jumper; 5-way; insulated; light gray



Item No.: 2004-406

Jumper; 6-way; insulated; light gray



Item No.: 2004-407

Jumper; 7-way; insulated; light gray



Item No.: 2004-408

Jumper; 8-way; insulated; light gray



Item No.: 2004-409

Jumper; 9-way; insulated; light gray



Item No.: 2004-440

Jumper; from 1 to 10; insulated; light gray



Item No.: 2004-433

Jumper; from 1 to 3; insulated; light gray



Item No.: 2004-434

Jumper; from 1 to 4; insulated; light gray



Item No.: 2004-435

Jumper; from 1 to 5; insulated; light gray



Item No.: 2004-436

Jumper; from 1 to 6; insulated; light gray



Item No.: 2004-437

Jumper; from 1 to 7; insulated; light gray



Item No.: 2004-438

Jumper; from 1 to 8; insulated; light gray



Item No.: 2004-439

Jumper; from 1 to 9; insulated; light gray



Item No.: 2004-405/011-000

Star point jumper; 3-way; insulated; light gray



Item No.: 210-103

Wire commoning chain; insulated; black



Item No.: 210-123

Wire commoning chain; insulated; blue

1.2.7 Marking

1.2.7.1 Group marker carrier



Item No.: 2009-191

Group marker carrier; gray



Item No.: 2009-192

Group marker carrier; gray



Item No.: 2009-193

Group marker carrier; gray

1.2.7.2 Marker



Item No.: 2009-145/000-006

Mini-WSB Inline; for Smart Printer; 1700 pieces on roll; stretchable 5 - 5.2 mm; plain; snap-on type; blue



Item No.: 2009-145/000-007

Mini-WSB Inline; for Smart Printer; 1700 pieces on roll; stretchable 5 - 5.2 mm; plain; snap-on type; gray



Item No.: 2009-145/000-023

Mini-WSB Inline; for Smart Printer; 1700 pieces on roll; stretchable 5 - 5.2 mm; plain; snap-on type; green



Item No.: 2009-145/000-012

Mini-WSB Inline; for Smart Printer; 1700 pieces on roll; stretchable 5 - 5.2 mm; plain; snap-on type; orange



Item No.: 2009-145/000-005

Mini-WSB Inline; for Smart Printer; 1700 pieces on roll; stretchable 5 - 5.2 mm; plain; snap-on type; red



Item No.: 2009-145/000-024

Mini-WSB Inline; for Smart Printer; 1700 pieces on roll; stretchable 5 - 5.2 mm; plain; snap-on type; violet



Item No.: 2009-145

Mini-WSB Inline; for Smart Printer; 1700 pieces on roll; stretchable 5 - 5.2 mm; plain; snap-on type; white



Item No.: 2009-145/000-002

Mini-WSB Inline; for Smart Printer; 1700 pieces on roll; stretchable 5 - 5.2 mm; plain; snap-on type; yellow

1.2.7.2 Marker



Item No.: 248-501/000-006

Mini-WSB marking card; as card; not stretchable; plain; snap-on type; blue

Item No.: 248-501/000-007

Mini-WSB marking card; as card; not stretchable; plain; snap-on type; gray

Item No.: 248-501/000-023

Mini-WSB marking card; as card; not stretchable; plain; snap-on type; green

Item No.: 248-501/000-017

Mini-WSB marking card; as card; not stretchable; plain; snap-on type; light green



Item No.: 248-501/000-012

Mini-WSB marking card; as card; not stretchable; plain; snap-on type; orange

Item No.: 248-501/000-005

Mini-WSB marking card; as card; not stretchable; plain; snap-on type; red

Item No.: 248-501/000-024

Mini-WSB marking card; as card; not stretchable; plain; snap-on type; violet

Item No.: 248-501

Mini-WSB marking card; as card; not stretchable; plain; snap-on type; white



Item No.: 248-501/000-002

Mini-WSB marking card; as card; not stretchable; plain; snap-on type; yellow

Item No.: 793-5501/000-006

WMB marking card; as card; for terminal block width 5 - 17.5 mm; stretchable 5 - 5.2 mm; plain; snap-on type; blue

Item No.: 793-5501/000-014

WMB marking card; as card; for terminal block width 5 - 17.5 mm; stretchable 5 - 5.2 mm; plain; snap-on type; brown

Item No.: 793-5501/000-007

WMB marking card; as card; for terminal block width 5 - 17.5 mm; stretchable 5 - 5.2 mm; plain; snap-on type; gray



Item No.: 793-5501/000-023

WMB marking card; as card; for terminal block width 5 - 17.5 mm; stretchable 5 - 5.2 mm; plain; snap-on type; green

Item No.: 793-5501/000-017

WMB marking card; as card; for terminal block width 5 - 17.5 mm; stretchable 5 - 5.2 mm; plain; snap-on type; light green

Item No.: 793-5501/000-012

WMB marking card; as card; for terminal block width 5 - 17.5 mm; stretchable 5 - 5.2 mm; plain; snap-on type; orange

Item No.: 793-5501/000-005

WMB marking card; as card; for terminal block width 5 - 17.5 mm; stretchable 5 - 5.2 mm; plain; snap-on type; red



Item No.: 793-5501/000-024

WMB marking card; as card; for terminal block width 5 - 17.5 mm; stretchable 5 - 5.2 mm; plain; snap-on type; violet

Item No.: 793-5501

WMB marking card; as card; for terminal block width 5 - 17.5 mm; stretchable 5 - 5.2 mm; plain; snap-on type; white

Item No.: 793-5501/000-002

WMB marking card; as card; for terminal block width 5 - 17.5 mm; stretchable 5 - 5.2 mm; plain; snap-on type; yellow

Item No.: 793-501/000-006

WMB marking card; as card; not stretchable; plain; snap-on type; blue



Item No.: 793-501/000-007

WMB marking card; as card; not stretchable; plain; snap-on type; gray

Item No.: 793-501/000-023

WMB marking card; as card; not stretchable; plain; snap-on type; green

Item No.: 793-501/000-017

WMB marking card; as card; not stretchable; plain; snap-on type; light green

Item No.: 793-501/000-012

WMB marking card; as card; not stretchable; plain; snap-on type; orange



Item No.: 793-501/000-005

WMB marking card; as card; not stretchable; plain; snap-on type; red

Item No.: 793-501/000-024

WMB marking card; as card; not stretchable; plain; snap-on type; violet

Item No.: 793-501

WMB marking card; as card; not stretchable; plain; snap-on type; white

Item No.: 793-501/000-002

WMB marking card; as card; not stretchable; plain; snap-on type; yellow



Item No.: 2009-115/000-006

WMB-Inline; for Smart Printer; 1500 pieces on roll; stretchable 5 - 5.2 mm; plain; snap-on type; blue

Item No.: 2009-115/000-007

WMB-Inline; for Smart Printer; 1500 pieces on roll; stretchable 5 - 5.2 mm; plain; snap-on type; gray

Item No.: 2009-115/000-023

WMB-Inline; for Smart Printer; 1500 pieces on roll; stretchable 5 - 5.2 mm; plain; snap-on type; green

Item No.: 2009-115/000-017

WMB-Inline; for Smart Printer; 1500 pieces on roll; stretchable 5 - 5.2 mm; plain; snap-on type; light green



Item No.: 2009-115/000-012

WMB-Inline; for Smart Printer; 1500 pieces on roll; stretchable 5 - 5.2 mm; plain; snap-on type; orange

Item No.: 2009-115/000-005

WMB-Inline; for Smart Printer; 1500 pieces on roll; stretchable 5 - 5.2 mm; plain; snap-on type; red

Item No.: 2009-115/000-024

WMB-Inline; for Smart Printer; 1500 pieces on roll; stretchable 5 - 5.2 mm; plain; snap-on type; violet

Item No.: 2009-115

WMB-Inline; for Smart Printer; 1500 pieces on roll; stretchable 5 - 5.2 mm; plain; snap-on type; white



Item No.: 2009-115/000-002

WMB-Inline; for Smart Printer; 1500 pieces on roll; stretchable 5 - 5.2 mm; plain; snap-on type; yellow

1.2.7.3 Marker carrier



Item No.: 2009-198

Adaptor; gray

1.2.7.4 Marking strip



Item No.: 2009-110

Marking strips; for Smart Printer; on reel; not stretchable; plain; snap-on type; white

1.2.8 Protective warning marker

1.2.8.1 Cover



Item No.: 2004-115

Protective warning marker; for 5 terminal blocks; with high-voltage symbol, black; yellow

1.2.9 Screwless end stop

1.2.9.1 Mounting accessories



Item No.: 249-117

Screwless end stop; 10 mm wide; for DIN-rail 35 x 15 and 35 x 7.5; gray



Item No.: 249-116

Screwless end stop; 6 mm wide; for DIN-rail 35 x 15 and 35 x 7.5; gray

1.2.10 Test and measurement

1.2.10.1 Testing accessories



Item No.: 2004-511

Modular TOPJOB®S connector; modular; for jumper contact slot; 1-pole; gray



Item No.: 2004-552

Modular TOPJOB®S connector; modular; for jumper contact slot; 2-pole; gray



Item No.: 2004-553

Modular TOPJOB®S connector; modular; for jumper contact slot; 3-pole; gray



Item No.: 2004-554

Modular TOPJOB®S connector; modular; for jumper contact slot; 4-pole; gray



Item No.: 2004-555

Modular TOPJOB®S connector; modular; for jumper contact slot; 5-pole; gray



Item No.: 2004-549

Spacer module; modular; e.g., for bridging commoned terminal blocks; gray



Item No.: 2009-174

Test plug adapter; for 4 mm Ø test plugs; for testing TOPJOB®S rail-mounted terminal blocks; gray



Item No.: 2009-182

Testing tap; for max. 2.5 mm²; tool-free connection for individual test wires 0.08 - 2.5 mm; gray

1.2.11 Tool

1.2.11.1 Operating tool



Item No.: 210-658

Operating tool; Blade: 3.5 x 0.5 mm; with a partially insulated shaft; angled; short; multicoloured



Item No.: 210-720

Operating tool; Blade: 3.5 x 0.5 mm; with a partially insulated shaft; multicoloured

Installation Notes

Conductor termination

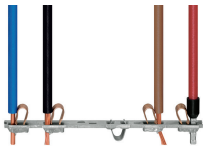

All conductor types at a glance

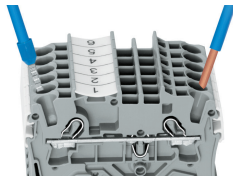

Push-in termination of solid and ferruled conductors

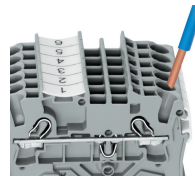

Inserting a conductor via push-in termination:
Solid conductors with cross-sections from either one size above, or up to two sizes below, the rated cross-section can be simply pushed in – no tools needed.

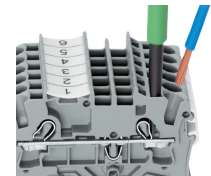

Inserting a conductor via operating tool:
Connecting fine-stranded conductors without ferrules, or small cross-sectional conductors that cannot be pushed in, is performed similarly to the original CAGE CLAMP® – just use an operating tool.
Advantage:
To open the clamp, the operating tool is inserted vertically. The conductor entry is less than 15 degrees for easier wiring.

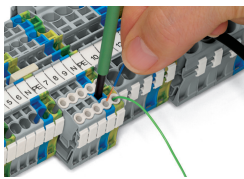

Conductor termination – insulation stop

Commoning

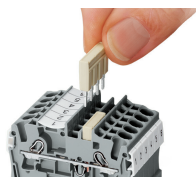

Insert push-in type jumper bar and push down until it hits backstop.

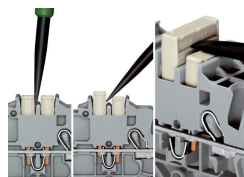

Removing a push-in type jumper bar:
Insert the operating tool between the jumper and partition wall of the dual jumper slots, then lift up the jumper. Place the operating tool in the center of jumpers for up to five contacts (see above), or alternately on both sides for jumpers with more than five contacts.

Commoning

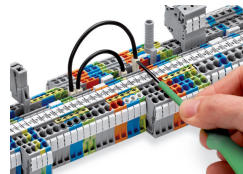
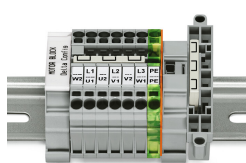
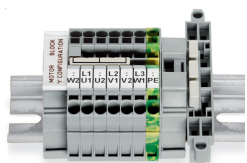

This star point jumper has been specially developed to create a "star point" and is used on motor terminal boards equipped with Rail-Mount Terminal Blocks TOPJOB® S.

This delta jumper has been specially developed to create a delta configuration and is used on motor terminal boards equipped with rail-mount terminal blocks TOPJOB® S.

Push down the wire jumper until fully inserted. Lift the jumper with an operating tool for rewiring.

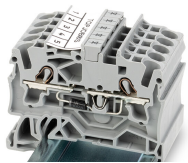

These diode terminal blocks have been specially developed for custom diode circuits, such as lamp test and collective fault signal circuits.

Testing

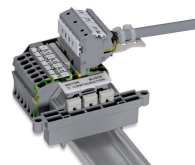
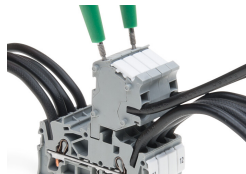
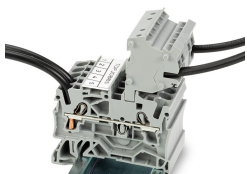

The modular TOPJOB® S connectors also connect conductors of the same size as the terminal blocks being used.

TOPJOB® S Connectors with a 2 mm Ø test socket for testing voltage via 2-pole voltage tester

Rail-mount terminal block assembly for electric motor wiring

Test plug adapter (Item No. 2009-174, CAT I) for 4 mm Ø plugs – compatible with 2000 to 2016 Series



Testing tap (Item No. 2009-182) for tool-free connection of test cables up to 2.5 mm² (12 AWG) – compatible with 2000 to 2016 Series

Marking

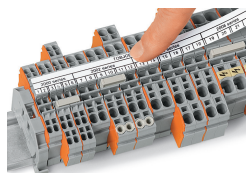
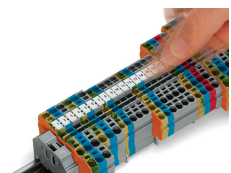

Snapping WMB Inline markers into marker slots.



Open diode gates can be created using the following terminal blocks:
2004-1211/1000-400 or
2004-1211/1000-401