

*intercable*

## Datasheet Al/Cu Verbinders Al - 500mm<sup>2</sup> rm/sm, 0mm<sup>2</sup> se / Cu – 300mm<sup>2</sup> rm/sm DIN46267

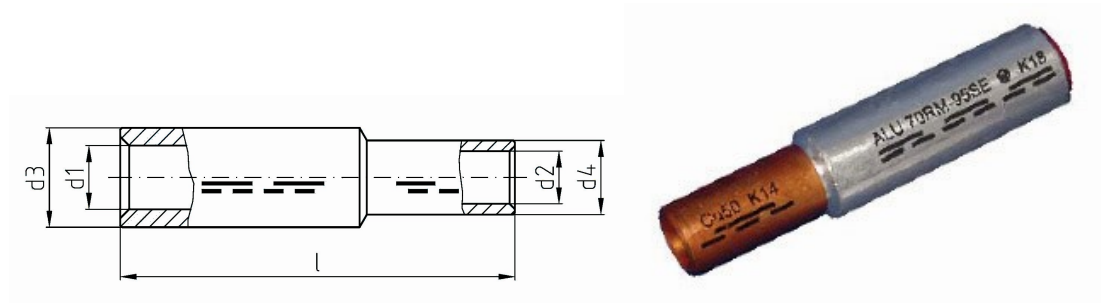

<b>Artikelnummer</b>	ICALCU500300V
<b>Doorsnede kabel</b>	
Rond/Sector meerdradig	500mm <sup>2</sup>
Sector enkeldradig	0mm <sup>2</sup>
Koper (Cu) Rond/ Sector meerdradig	300mm <sup>2</sup>
<b>Materiaal</b>	Al 99,5/ CU-ETP vlgns. DIN13601
<b>Afwerking</b>	Blank, met contactvet gevuld, gesloten
<b>Referentienummer (kengetal) t.b.v. matrijsnummer)</b>	Al 44 / CU 32

### Maten:

<b>D1</b>	29mm
<b>D3</b>	44mm
<b>D2</b>	24.5mm
<b>D4</b>	32mm
<b>L</b>	149
<b>Gewicht</b>	41.73kg/100
	kg Cu/100