

Data Sheet | Item Number: 280-502/281-610

Component terminal block; double-deck; with varistor; for DIN-rail 35 x 15 and 35 x 7.5; 2.5 mm²; CAGE CLAMP®; gray

<https://www.wago.com/280-502/281-610>

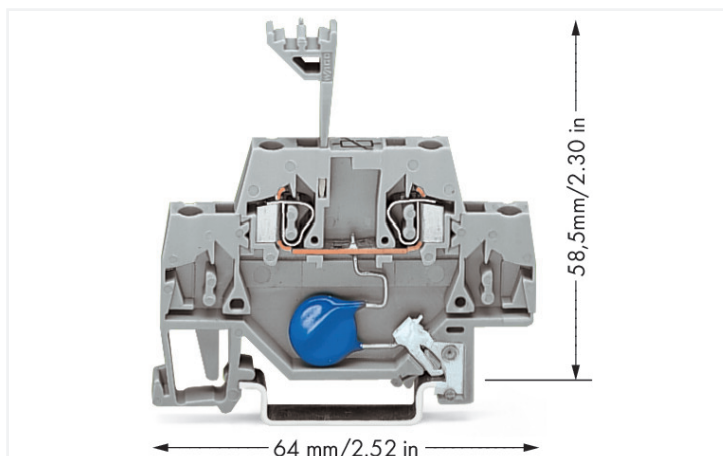

Color: ■ gray

Similar to illustration

Similar to illustration

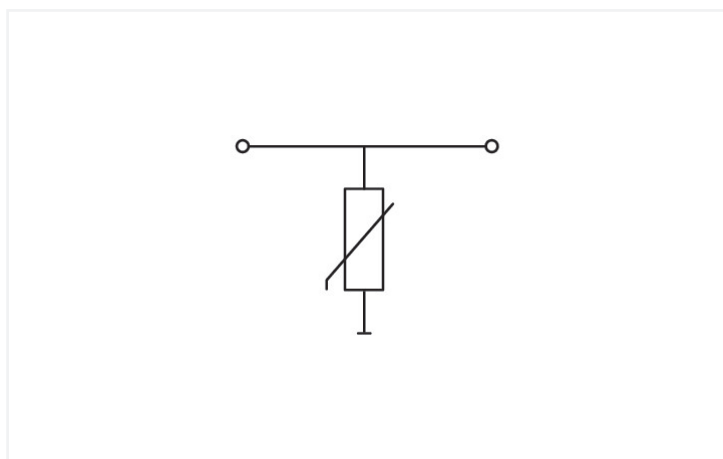

Short description:

WAGO's component terminal block with single-stage surge suppression device and direct connection to DIN-35 rail is equipped with a varistor.

Features:

- Protect your system against overvoltage
- Slim, space-saving design
- Control operational costs by preventing expensive, unplanned downtime
- High operational reliability and system uptime

Notes

Safety Information

- Installation must be performed by qualified personnel only.
- The DIN-rail must be grounded.
- The input current must be protected by a suitable fuse.
- Protection against contact with stored charges must be ensured.
- Do not insert or remove pluggable modules when energized.
- The IP20 protection rating must be maintained in the assembled state or when using an end/intermediate plate compatible with the rail-mount terminal block.

Electrical data

Nominal operating voltage	48 VDC
Maximum continuous voltage	65 VDC
Rated continuous current	20 A
Nominal discharge current (8/20 µs) (line)	300 A
Discharge current (max.)	1.2 kA
Protection level (8/20 µs)	≤ 135 VDC
Capacitance	≤ 500 pF

Safety and protection

Protection type	IP00
-----------------	------

Connection Data

Wiring direction	Front-entry wiring
Connections (number)	2
Connection technology	CAGE CLAMP®
Solid conductor	0.08 ... 2.5 mm ² / 28 ... 14 AWG
Fine-stranded conductor	0.08 ... 2.5 mm ² / 28 ... 14 AWG
Strip length	8 ... 9 mm / 0.31 ... 0.35 inches

Physical data

Width	5 mm / 0.197 inches
Height	64 mm / 2.52 inches
Depth from upper-edge of DIN-rail	58.5 mm / 2.303 inches

Mechanical data

Design	with direct connection to DIN-rail
Mounting type	DIN-35 rail

Material data

Color	gray
Insulation material (main housing)	Polyamide (PA66)
Material group	I
Flammability class per UL94	V0
Fire load	0.172 MJ
Weight	8.5 g

Environmental requirements

Ambient temperature (operation)	-25 ... +70 °C
Processing temperature	-35 ... +85 °C
Operating altitude (max.)	2000 m

Standards and Specifications

Standards/specifications	EN 60947-7-1 EN 60512-5-2
--------------------------	------------------------------

Commercial data

Product Group	1 (Rail Mounted Terminal Blocks)
PU (SPU)	50 pcs
Packaging type	Box
Country of origin	DE
GTIN	4050821861171
Customs tariff number	85369010000

Product Classification

UNSPSC	39121410
eCl@ss 10.0	27-14-11-27
eCl@ss 9.0	27-14-11-27
ETIM 9.0	EC000903
ETIM 10.0	EC000903
ECCN	NO US CLASSIFICATION

Environmental Product Compliance

RoHS Compliance Status	Compliant, No Exemption
------------------------	-------------------------

Approvals / Certificates

Declarations of conformity and manufacturer's declarations

Approval	Standard	Certificate Name
EU-Declaration of Conformity WAGO GmbH & Co. KG	-	-
UK-Declaration of Conformity WAGO GmbH & Co. KG	-	-

Downloads

Environmental Product Compliance

Compliance Search	
Environmental Product Compliance 280-502/281-610	

Documentation

Bid Text			
280-502/281-610	19.02.2019	xml 3.35 KB	
280-502/281-610	11.02.2015	doc 25.50 KB	

CAD/CAE-Data

CAD data	
2D/3D Models 280-502/281-610	

CAE data	
EPLAN Data Portal 280-502/281-610	
WSCAD Universe 280-502/281-610	
ZUKEN Portal 280-502/281-610	

1 Compatible Products

1.1 Required Accessories

1.1.1 End plate

1.1.1.1 End plate



Item No.: 280-340
End and intermediate plate; 2.5 mm thick; gray

Item No.: 280-341
End and intermediate plate; 2.5 mm thick; orange

1.2 Optional Accessories

1.2.1 Insulation stop

1.2.1.1 Insulation stop



Item No.: 280-470
Insulation stop; 0.08 - 0.2 mm² "s" (0.14 mm² "f-st"); 5 pieces/strip; white

Item No.: 280-471
Insulation stop; 0.25 - 0.5 mm²; 5 pieces/strip; light gray

Item No.: 280-472
Insulation stop; 0.75 - 1 mm²; 5 pieces/strip; black

1.2.2 Jumper

1.2.2.1 Jumper



Item No.: 280-490
Jumper; 10-way; insulated; gray

Item No.: 280-482
Jumper; 2-way; insulated; gray

Item No.: 280-492
Jumper; 2-way; insulated; gray

Item No.: 280-483
Jumper; 3-way; insulated; gray



Item No.: 280-484
Jumper; 4-way; insulated; gray

Item No.: 280-485
Jumper; 5-way; insulated; gray

1.2.3 Marking

1.2.3.1 Marker



Item No.: 793-502

WMB marking card; as card; MARKED; 1 ... 10 (10x); not stretchable; Horizontal marking; snap-on type; white



Item No.: 793-503

WMB marking card; as card; MARKED; 11 ... 20 (10x); not stretchable; Horizontal marking; snap-on type; white



Item No.: 793-504

WMB marking card; as card; MARKED; 21 ... 30 (10x); not stretchable; Horizontal marking; snap-on type; white



Item No.: 793-505

WMB marking card; as card; MARKED; 31 ... 40 (10x); not stretchable; Horizontal marking; snap-on type; white



Item No.: 793-506

WMB marking card; as card; MARKED; 41 ... 50 (10x); not stretchable; Horizontal marking; snap-on type; white



Item No.: 793-501

WMB marking card; as card; not stretchable; plain; snap-on type; white



Item No.: 2009-115

WMB-Inline; for Smart Printer; 1500 pieces on roll; stretchable 5 - 5.2 mm; plain; snap-on type; white

1.2.4 Tool

1.2.4.1 Operating tool



Item No.: 210-720

Operating tool; Blade: 3.5 x 0.5 mm; with a partially insulated shaft; multicoloured