

## Wilo-Control EC/ECe-Booster



en Installation and operating instructions



## Table of contents

<b>1 General</b> .....	<b>4</b>	9.1 Personnel qualifications .....	45
1.1 About these instructions .....	4	9.2 Operator responsibilities .....	45
1.2 Copyright .....	4	9.3 Shut-down .....	45
1.3 Subject to change .....	4	9.4 Removal .....	46
1.4 Exclusion from warranty and liability.....	4	<b>10 Maintenance</b> .....	<b>46</b>
<b>2 Safety</b> .....	<b>4</b>	10.1 Maintenance intervals.....	46
2.1 Identification of safety instructions .....	4	10.2 Maintenance tasks.....	46
2.2 Personnel qualifications.....	5	<b>11 Faults, causes and remedies</b> .....	<b>47</b>
2.3 Electrical work .....	6	11.1 Operator responsibilities .....	47
2.4 Monitoring devices .....	6	11.2 Fault indication .....	47
2.5 Installing/dismantling.....	6	11.3 Fault acknowledgement.....	47
2.6 During operation.....	6	11.4 Fault memory .....	48
2.7 Maintenance tasks.....	6	11.5 Error codes.....	48
2.8 Operator responsibilities .....	7	11.6 Further steps for troubleshooting.....	48
<b>3 Application/use</b> .....	<b>7</b>	<b>12 Disposal</b> .....	<b>48</b>
3.1 Intended use .....	7	12.1 Information on the collection of used electrical and elec- tronic products.....	48
3.2 Improper use.....	7	<b>13 Appendix</b> .....	<b>49</b>
<b>4 Product description</b> .....	<b>7</b>	13.1 System impedances .....	49
4.1 Structure .....	7	13.2 Overview of the symbols.....	50
4.2 How it works.....	7	13.3 Overview of terminal diagrams.....	50
4.3 Technical data .....	8	13.4 ModBus: Data types.....	52
4.4 Inputs and outputs .....	8	13.5 ModBus: Parameter overview .....	53
4.5 Type key.....	9		
4.6 Operation on electronic start-up controllers .....	9		
4.7 Installation in potentially explosive atmospheres .....	9		
4.8 Scope of delivery.....	9		
4.9 Accessories .....	9		
<b>5 Transportation and storage</b> .....	<b>9</b>		
5.1 Delivery.....	9		
5.2 Transport.....	10		
5.3 Storage .....	10		
<b>6 Installation</b> .....	<b>10</b>		
6.1 Personnel qualifications.....	10		
6.2 Installation types .....	10		
6.3 Operator responsibilities .....	10		
6.4 Installation .....	10		
6.5 Electrical connection.....	11		
<b>7 Operation</b> .....	<b>24</b>		
7.1 How it works.....	25		
7.2 Menu control .....	27		
7.3 Menu type: Main menu or Easy Actions menu.....	27		
7.4 Call up the menu .....	27		
7.5 Quick access to “Easy Actions” .....	27		
7.6 Factory settings .....	28		
<b>8 Commissioning</b> .....	<b>28</b>		
8.1 Operator responsibilities .....	28		
8.2 Activating the switchgear .....	28		
8.3 Start initial configuration.....	29		
8.4 Start automatic mode .....	43		
8.5 During operation.....	43		
<b>9 Shut-down</b> .....	<b>45</b>		

## 1 General

### 1.1 About these instructions

These instructions form part of the product. Compliance with the instructions is essential for correct handling and use:

- Read the instructions carefully before all activities.
- Keep the instructions in an accessible place at all times.
- Observe all product specifications.
- Observe the markings on the product.

The language of the original operating instructions is German. All other languages of these instructions are translations of the original operating instructions.

### 1.2 Copyright

WILO SE © 2023

The reproduction, distribution and utilisation of this document in addition to communication of its contents to others without express consent is prohibited. Offenders will be held liable for payment of damages. All rights reserved.

### 1.3 Subject to change

Wilo shall reserve the right to change the listed data without notice and shall not be liable for technical inaccuracies and/or omissions. The illustrations used may differ from the original and are intended as an exemplary representation of the product.

### 1.4 Exclusion from warranty and liability

Wilo shall specifically not assume any warranty or liability in the following cases:

- Inadequate configuration due to inadequate or incorrect instructions by the operator or the client
- Non-compliance with these instructions
- Improper use
- Incorrect storage or transport
- Incorrect installation or dismantling
- Insufficient maintenance
- Unauthorised repairs
- Inadequate construction site
- Chemical, electrical or electrochemical influences
- Wear

## 2 Safety

This chapter contains basic information for the individual phases of the life cycle. Failure to observe this information carries the following risks:

- Risk of personal injury from electrical, electromagnetic or mechanical influences
- Environmental damage from discharge of hazardous substances
- Damage to property
- Failure of important functions

Failure to observe the information contained herein will result in the loss of claims for damages.

**The instructions and safety instructions in the other chapters must also be observed!**

### 2.1 Identification of safety instructions

These installation and operating instructions set out safety instructions for preventing personal injury and damage to property, which are displayed in different ways:

- Safety instructions relating to personal injury start with a signal word and are **preceded by a corresponding symbol**.





## DANGER

### Type and source of the danger!

Consequences of the danger and instructions for avoidance.

- Safety instructions relating to property damage start with a signal word and are displayed **without** a symbol.

---

## CAUTION

### Type and source of the danger!

Consequences or information.

---

### Signal words

- **Danger!**  
Failure to observe safety instructions will result in serious injury or death!
- **Warning!**  
Failure to follow instructions can lead to (serious) injury!
- **Caution!**  
Failure to follow instructions can lead to property damage and possible total loss.
- **Notice!**  
Useful information on handling the product

### Markups

- ✓ Prerequisite
- 1. Work step/list
  - ⇒ Notice/instructions
  - ▶ Result

### Symbols

These instructions use the following symbols:



Danger of electric voltage



Danger – explosive atmosphere



Useful information

## 2.2 Personnel qualifications

- Personnel have been instructed on locally applicable regulations governing accident prevention.
- Personnel have read and understood the installation and operating instructions.
- Electrical work: qualified electrician  
Person with appropriate technical training, knowledge and experience who can identify and prevent electrical hazards.
- Installation/dismantling work: qualified electrician  
Knowledge regarding tools and fixation material for various structures

## 2.3 Electrical work

- Operation/control: Operating personnel, instructed in the functioning of the complete system
- Electrical work must be carried out by a qualified electrician.
- Before commencing work, disconnect the product from the mains and safeguard it from being switched on again.
- Observe applicable local regulations when connecting to the mains power supply.
- Adhere to the requirements of the local energy supply company.
- Earth the product.
- Observe technical information.
- Replace a defective connection cable immediately.

## 2.4 Monitoring devices

### Circuit breakers/Fuses

The size and switching characteristics of the circuit breakers/fuses must conform to the rated current of the connected consumer. Observe local regulations.

## 2.5 Installing/dismantling

- Locally applicable laws and regulations on work safety and accident prevention must be complied with.
- Disconnect the product from the mains and secure it against being switched on again.
- Suitable fixation material must be used for the existing bearing surface.
- The product is not watertight. Select an appropriate installation site!
- Do not deform the housing during installation. Seals could leak and affect the stated IP protection class.
- The product may **not** be installed in potentially explosive areas.

## 2.6 During operation

- The product is not watertight. Comply with protection class IP54.
- Ambient temperature: 0 ... 40 °C.
- Maximum humidity: 90 %, non-condensing.
- Do not open the switchgear.
- The user must notify the person in charge of every fault or irregularity immediately.
- In case of damage to the product or connection cable, switch off the product immediately.

## 2.7 Maintenance tasks

- Do not use any aggressive cleaners or scouring agents or fluids.
- The product is not watertight. Do not submerge the product in fluids.
- Only carry out maintenance tasks mentioned in these installation and operating instructions.

## 2.8 Operator responsibilities

- Only original parts from the manufacturer may be used for maintenance and repairs. Use of parts other than the original parts releases the manufacturer from any liability.
- Provide installation and operating instructions in a language which the personnel can understand.
- Make sure that the personnel has had the corresponding training for the specified work.
- Safety and information signs mounted on the device must always be legible.
- Train the personnel on how the system operates.
- Eliminate risk from electrical current.
- To ensure safe working practice, define personnel responsibilities.

Children and persons younger than 16 years or with reduced physical, sensory or mental capacities or limited experience are prohibited from handling the product! A technician must supervise persons younger than 18 years!

## 3 Application/use

### 3.1 Intended use

The switchgear is suitable for the pressure-dependent control of up to three pumps:

- Control EC-Booster: uncontrolled fixed-speed pumps
- Control ECe-Booster: electronically controlled variable-speed pumps

The signal is acquired using a pressure sensor.

Intended use includes compliance with this manual. Any other use is regarded as non-compliant with intended use.

### 3.2 Improper use

- Installation in potentially explosive atmospheres
- Overflow of the switchgear

## 4 Product description

### 4.1 Structure

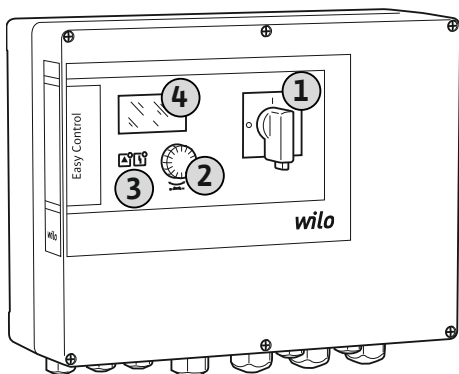

1	Main switch
2	Operating button
3	LED indicators
4	LCD display

The front of the switchgear comprises the following main components:

- Main switch for switching the switchgear on/off
- Operating button for menu selection and parameter input
- LEDs for displaying the current operating state
- LCD display for showing the current operating data and individual menu items

The position of the individual operating elements is the same for the plastic and metal housing.

Fig. 1: Switchgear front

### 4.2 How it works

The pumps are switched on/off individually and automatically depending on the actual pressure in the system. The pressure control for the Control EC-Booster is carried out using a two-point controller. The pressure control for the Control ECe-Booster is carried out using a PID controller. When the dry running level is reached, a visual signal is displayed and a forced switch-off of all the pumps occurs. Faults are stored in the fault memory.

The current operating data and operating conditions are shown on the LCD display and indicated by LEDs. Operation and the input of operating parameters is carried out using a rotary knob.

#### 4.3 Technical data

Date of manufacture*	See rating plate
Mains connection	See rating plate
Mains frequency	50/60 Hz
Max. current consumption per pump	See type designation
Max. rated power per pump	See rating plate
Pump activation type	See type designation
Ambient/operating temperature	0 ... 40 °C
Storage temperature	-30 ... +60 °C
Max. relative humidity	90 %, non-condensing
Protection class	IP54
Electrical safety	Pollution degree II
Control voltage	See rating plate
Housing material	UV-resistant polycarbonate or powder-coated steel sheeting

Details about the Software version (SW) can be found on the rating plate!

\*The date of manufacture is stated in accordance with ISO 8601: JJJJWww

- JJJJ = year
- W = abbreviation for week
- ww = calendar week

#### 4.4 Inputs and outputs

Inputs	Number of inputs					
	EC-B1 ...	EC-B2 ...	EC-B3 ...	ECe-B1 ...	ECe-B2 ...	ECe-B3 ...
<b>System control</b>						
Passive pressure sensor 4 to 20 mA	1	1	1	1	1	1
<b>Low water level (dry-running protection)</b>						
Float switch/pressure switch	1	1	1	1	1	1
Electrode	1	1	-	1	1	-
<b>Pump monitoring</b>						
Thermal winding monitor (bimetallic sensor)	1	2	3	-	-	-
Thermal winding monitor (PTC sensor)	-	-	-	-	-	-
Thermal winding monitor (Pt100 sensor)	-	-	-	-	-	-
Fault message frequency converter	-	-	-	1	2	3
<b>Other inputs</b>						
Extern OFF: for remote deactivation of all pumps	1	1	1	1	1	1

#### Key

1/2/3 = number of inputs, - = not available

Outputs	Number of outputs					
	EC-B1 ...	EC-B2 ...	EC-B3 ...	ECe-B1 ...	ECe-B2 ...	ECe-B3 ...
<b>Potential-free contacts</b>						
Collective fault signal (changeover contact)	1	1	1	1	1	1
Collective run signal (changeover contact)	1	1	1	1	1	1
Individual fault signal (closed contact (NC))	1	2	3	1	2	3
Individual run signal (open contact (NO))	1	2	3	1	2	3
Low water level/Dry-running protection (Normally closed contact (NC))	1	1	1	1	1	1

Outputs	Number of outputs					
	EC-B1 ...	EC-B2 ...	EC-B3 ...	ECe-B1 ...	ECe-B2 ...	ECe-B3 ...
<b>Other outputs</b>						
Output of the speed setpoint (0 to 10 V=)	–	–	–	1	1	1

**Key**

1/2/3 = number of outputs, – = not available

**4.5 Type key**

Example: Wilo-Control ECe-B 2x12A-T34-DOL-WM	
ECe	Version with Easy Control switchgear: – EC = switchgear for fixed-speed pumps – ECe = switchgear for electronically controlled variable-speed pumps
B	Control for pressure-boosting systems
2x	Max. number of pumps that can be connected
12A	Max. rated current per pump in amperes
T	Mains connection: M = alternating current (1~) T = three-phase current (3~)
34	Rated voltage: – 2 = 220/230 V – 34 = 380/400 V
DOL	Pump activation type: – DOL = direct on line – SD = star-delta
WM	Wall fixation

**4.6 Operation on electronic start-up controllers**

Connect the switchgear directly to the pump and the mains. Intermediate switching of additional electronic start-up controllers, e.g. a frequency converter, is not permitted!

**4.7 Installation in potentially explosive atmospheres**

The switchgear does not have its own explosion protection class. **Do not** install the switchgear in potentially explosive areas!

**4.8 Scope of delivery****Control EC-Booster**

- Switchgear
- Installation and operating instructions

**Control ECe-Booster**

- Switchgear
- Installation and operating instructions
- Circuit diagram

**4.9 Accessories**

- Float switch
- Pressure switch
- Electrode
- Pressure sensor 4 to 20 mA

**NOTICE****Accessories installed as required**

If the switchgear is delivered with a pressure-boosting system, the accessories may be pre-installed. Please check the order confirmation for further information.

**5 Transportation and storage****5.1 Delivery**

- After delivery, check product and packaging for defects (damage, completeness).
- Defects must be noted on the freight documentation.
- Defects must be notified to the transport company or the manufacturer on the day of receipt of shipment. Claims cannot be asserted if the notification of defects takes place at a later date.

## 5.2 Transport

### CAUTION

#### Damage to property due to wet packaging!

Wet packaging may tear. If unprotected, the product may fall on the ground and be irreparably damaged.

- Carefully lift wet packaging and replace it immediately!

## 5.3 Storage

- Clean control device.
- Close housing apertures, ensuring they are sealed watertight.
- Impact-resistant and watertight packaging.
- Pack the switchgear in dustproof and watertight packaging.
- Maintain storage temperature:  $-30 \dots +60 \text{ }^\circ\text{C}$ , max. relative humidity: 90 %, non-condensing.
- Frost-proof storage at a temperature of  $10 \text{ }^\circ\text{C}$  to  $25 \text{ }^\circ\text{C}$  with relative humidity of 40 ... 50 % is recommended.
- Avoid the formation of condensation at all times.
- All open threaded cable glands must be sealed to prevent water ingress into the housing.
- Attached cables should be protected against kinking, damage, and ingress of moisture.
- To prevent damage to the components, protect the switchgear from direct sunlight and heat.
- Clean the switchgear after storage.
- If there has been water ingress or condensation has formed, have all the electronic components tested for correct function. Contact customer service.

## 6 Installation

- Check the switchgear for damage caused during transport. Do **not** install defective switchgears!
- Observe the local guidelines for the design and operation of electronic controls.

### 6.1 Personnel qualifications

- Electrical work: qualified electrician  
Person with appropriate technical training, knowledge and experience who can identify and prevent electrical hazards.
- Installation/dismantling work: qualified electrician  
Knowledge regarding tools and fixation material for various structures

### 6.2 Installation types

- Installation of the switchgear directly onto the pressure-boosting system  
The switchgear is installed directly onto the pressure-boosting system at the factory.
- Wall fixation  
If the switchgear needs to be separately installed on a wall, follow the instructions in the "Installation" chapter.

### 6.3 Operator responsibilities

- The installation location is clean, dry and free of vibration.
- The installation location is overflow-proof.
- The switchgear is not exposed to direct sunlight.
- Installation location outside of potentially explosive atmospheres.

### 6.4 Installation

- The connection cable and required accessories should be provided by the customer.
- While laying the cable, ensure that there is no tension, no kinking and no pinching that could damage the cable.
- Check the cable cross-section and length for the routing type chosen.
- Seal unused threaded cable glands.
- Ensure that the following ambient conditions are adhered to:
  - Ambient/operating temperature:  $0 \dots 40 \text{ }^\circ\text{C}$
  - Relative humidity: 40 ... 50 %
  - Max. relative humidity: 90 %, non-condensing

#### 6.4.1 Basic advice on fixing the switchgear in place

Various structures can be used for installation (concrete wall, mounting rail, etc.). For this reason, the fixation material for the relevant construction must be provided by the customer and the following information must be observed:

- To prevent cracks in the masonry and chipping of the construction material, ensure sufficient clearance to the edge of the structure.

- The depth of the borehole depends on the length of the screws. Drill the borehole approx. 5 mm deeper than the screw length.
- Drilling dust impairs retention force. Always blow the borehole clean or vacuum it out.
- Do not damage the housing during installation.

#### 6.4.2 Installation of switchgear

##### Screw sizes for plastic housing

- Max. screw diameter:
  - Control EC-B 1x: 4 mm
  - Control EC-B 2x: 4 mm
  - Control EC-B 3x: 6 mm
- Max. screw head diameter:
  - Control EC-B 1x: 7 mm
  - Control EC-B 2x: 7 mm
  - Control EC-B 3x: 11 mm

##### Screw sizes for steel housing

- Max. screw diameter:
  - Control EC-B 1x/ECe-B 1x: 8 mm
  - Control EC-B 2x/ECe-B 2x: 8 mm
  - Control EC-B 3x/ECe-B 3x: 8 mm
- Min. screw head diameter:
  - Control EC-B 1x/ECe-B 1x: 12 mm
  - Control EC-B 2x/ECe-B 2x: 12 mm
  - Control EC-B 3x/ECe-B 3x: 12 mm

##### Installation

Attach the switchgear to the wall with four screws and wall plugs:

- ✓ Switchgear is disconnected from the mains supply and is voltage-free.
1. Loosen the screws on the cover and open the cover/switch cabinet door from the side.
  2. Align the switchgear on the installation site and mark the position for the drill holes.
  3. Drill and clean the mounting holes in accordance with the specifications of the fixation material.
  4. Attach the lower part to the wall with the fixation material.  
Check the lower part for deformations! Realign deformed housing (e.g. by placing alignment plates below it) to ensure the housing cover closes securely. **NOTICE! If the cover does not close correctly, the protection class is compromised!**
  5. Close the cover/switch cabinet door and fasten it with the screws.
    - ▶ Switchgear installed. Now connect the mains supply, pumps and signal transmitter.

#### 6.4.3 Low water level (dry-running protection)

The level can be measured via the following signal transmitters:

- Float switch  
The float switches must be able to move freely in the operating space (pump chamber, tank)!
- Pressure switch
- Electrode
  - **Only** Control EC-B/ECe-B 1x ... and EC-B/ECe-B 2x ...

A **forced switch-off** of all pumps always takes place in the event of an alarm, irrespective of the selected signal transmitter!

#### 6.5 Electrical connection



##### DANGER

##### Risk of fatal injury due to electrical current!

Improper conduct when carrying out electrical work can lead to death due to electric shock!

- Electrical work must be carried out by a qualified electrician!
- Observe local regulations!



## NOTICE

- Depending on the system impedance and the maximum connections/hour of the connected consumers, voltage fluctuations and/or drops may occur.
- When using shielded cables, attach the shielding to the earth rail on one side of the control device.
- Always have connection carried out by a qualified electrician.
- Observe the installation and operating instructions for the connected pumps and signal transmitters.

- The mains connection current and voltage must be as stated on the rating plate.
- Execute fuse protection on the mains side in accordance with the local guidelines.
- If circuit breakers are used, the switching characteristics should be selected according to the connected pump.
- Follow local guidelines if residual-current devices (RCD, type A, sinusoidal current, universal-current-sensitive) are installed.
- Route connection cable in accordance with the local guidelines.
- Do not damage the connection cable during routing or installation.
- Earth the switchgear and all electrical consumers.

### 6.5.1 Overview of components: Wilo-Control EC-Booster

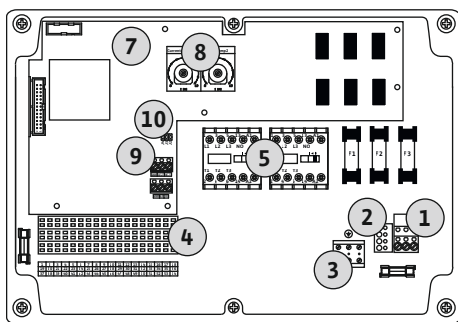

Fig. 2: Control EC-B 1 .../EC-B 2 ...

### Overview Control EC-B 1 .../EC-B 2 ..., up to 12 A rated current

1	Terminal strip: Mains connection
2	Mains voltage adjustment
3	Terminal strip: Earth (PE)
4	Terminal strip: Controls/sensors
5	Contactor combinations
7	Control board
8	Potentiometer for motor current monitoring
9	ModBus RTU: RS485 interface
10	ModBus RTU: Jumper for termination/polarisation



Overview Control EC-B 3 ..., up to 12 A rated current

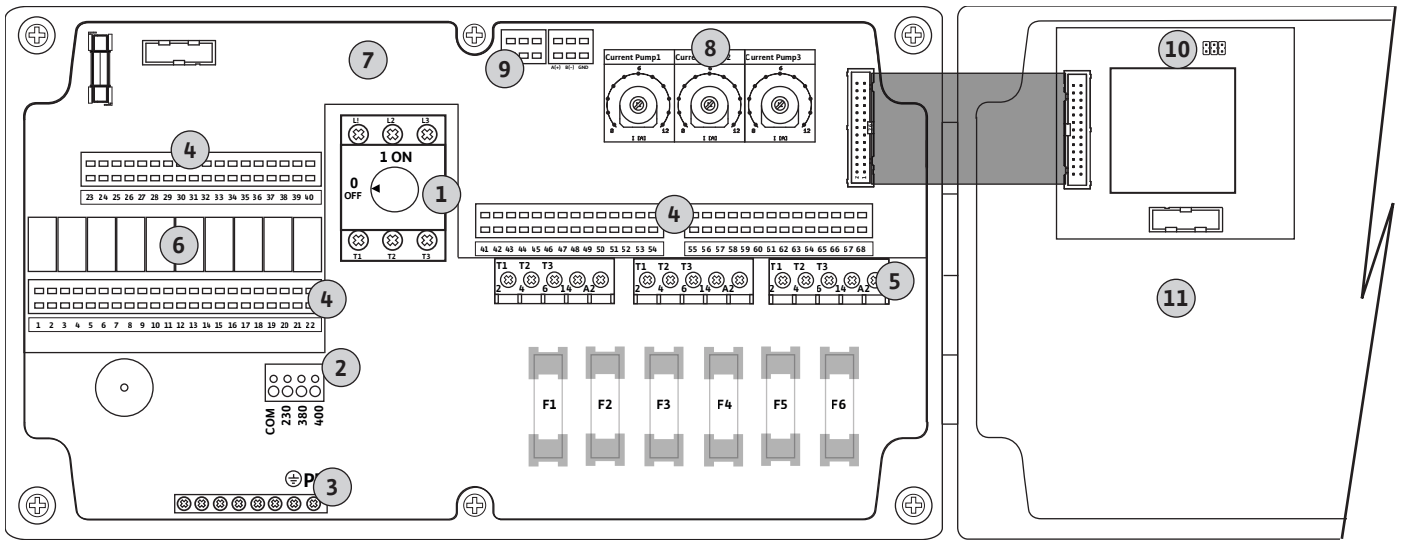

Fig. 3: Control EC-B 3...

1	Main switch/mains connection
2	Mains voltage adjustment
3	Terminal strip: Earth (PE)
4	Terminal strip: Controls/sensors
5	Contactor combinations
6	Output relay
7	Control board
8	Potentiometer for motor current monitoring
9	ModBus RTU: RS485 interface
10	ModBus RTU: Jumper for termination/polarisation
11	Housing cover

Overview Control EC-B 1 ... with a rated current greater than 12 A

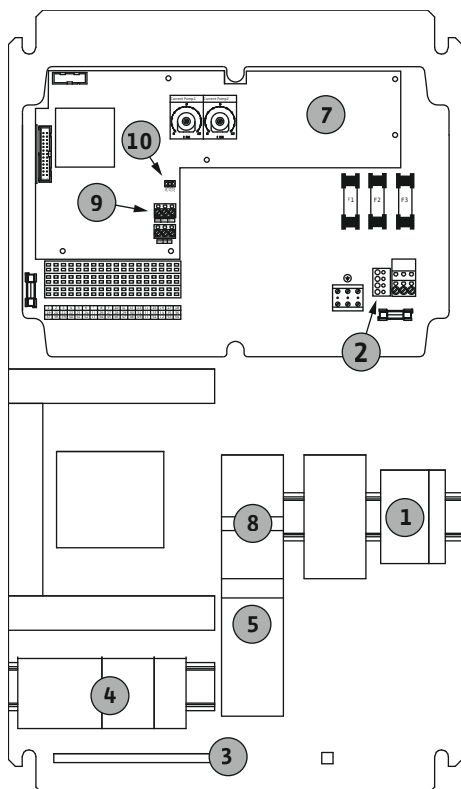

Fig. 4: Control EC-B 1 ...

1	Main switch/mains connection
2	Mains voltage adjustment
3	Terminal strip: Earth (PE)
4	Terminal strip: Controls/sensors
5	Motor protection for contactor combination
7	Control board
8	Motor protection switch
9	ModBus RTU: RS485 interface
10	ModBus RTU: Jumper for termination/polarisation

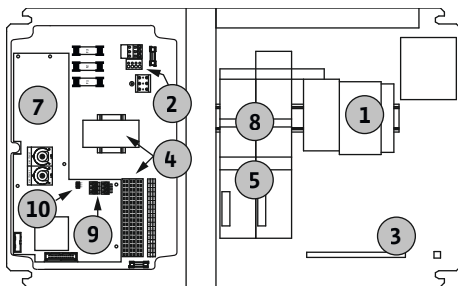

Fig. 5: Control EC-B 2 ...

### Overview Control EC-B 2 ... with a rated current greater than 12 A

1	Main switch/mains connection
2	Mains voltage adjustment
3	Terminal strip: Earth (PE)
4	Terminal strip: Controls/sensors
5	Contactor combinations
7	Control board
8	Motor protection switch
9	ModBus RTU: RS485 interface
10	ModBus RTU: Jumper for termination/polarisation

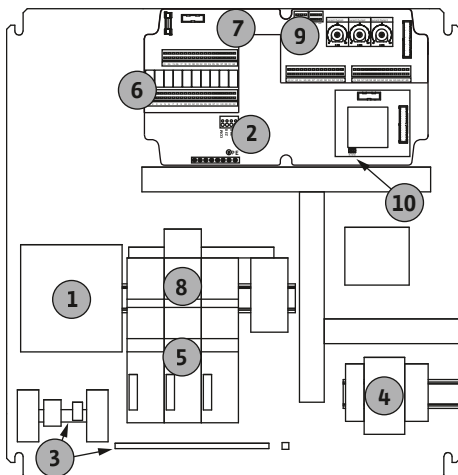

Fig. 6: Control EC-B 3 ...

### Overview Control EC-B 3 ... with a rated current greater than 12 A

1	Main switch/mains connection
2	Mains voltage adjustment
3	Terminal strip: Earth (PE)
4	Terminal strip: Controls/sensors
5	Motor protection for contactor combination
6	Output relay
7	Control board
8	Motor protection switch
9	ModBus RTU: RS485 interface
10	ModBus RTU: Jumper for termination/polarisation

### 6.5.2 Overview of components: Wilo-Control ECe-Booster

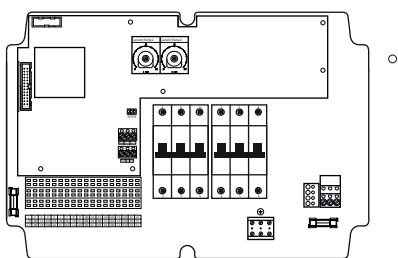

Fig. 7: Control ECe-B 1 .../ECe-B 2 ...

### Overview Control ECe-B 1 .../ECe-B 2 ...

1	Main switch/mains connection
3	Terminal strip: Earth (PE)
4	Terminal strip: Controls/sensors
5	Circuit breaker 3-pole (3~) / 2-pole (1~)
7	Control board
9	ModBus RTU: RS485 interface
10	ModBus RTU: Jumper for termination/polarisation

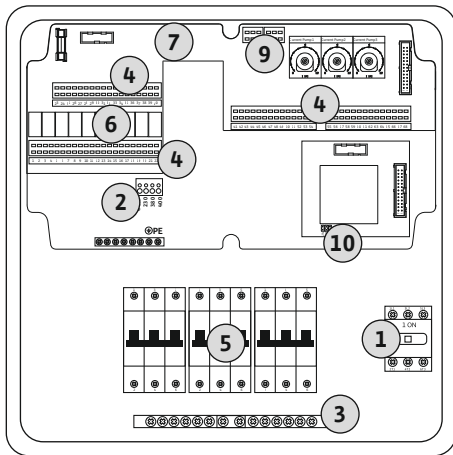

Fig. 8: Control ECe-B 3 ...

### 6.5.3 Switchgear mains connection: Control EC-Booster



#### DANGER

**Danger of death due to electrical current when the main switch is switched off!**

Even when the main switch is switched off, there is mains voltage power to the voltage selection terminal.

- Make the voltage selection before connecting the product to the mains.

#### CAUTION

**Risk of property damage due to incorrectly set mains voltage!**

If the wrong mains voltage is set, the switchgear will be destroyed. The switchgear can be operated at different mains voltages. The mains voltage is set to 400 V at the factory.

- To use another mains voltage, change the position of the cable jumper before connection.

#### Mains connection Wilo-Control EC-B 1 .../EC-B 2 ...

1	Terminal strip: Mains connection
2	Mains voltage adjustment
3	Terminal strip: Earth (PE)

Insert the connection cables laid by the customer through the threaded cable glands and secure. Connect the wires to the terminal strip according to the connection diagram.

Mains connection **1~230 V**:

- Cable: 3-core
- Wire: L, N, PE
- Mains voltage adjustment: Converter bridge 230/COM

Mains connection **3~230 V**:

- Cable: 4-core
- Wire: L1, L2, L3, PE
- Mains voltage adjustment: Converter bridge 230/COM

Mains connection **3~380 V**:

- Cable: 4-core
- Wire: L1, L2, L3, PE
- Mains voltage adjustment: Converter bridge 380/COM

Mains connection **3~400 V**:

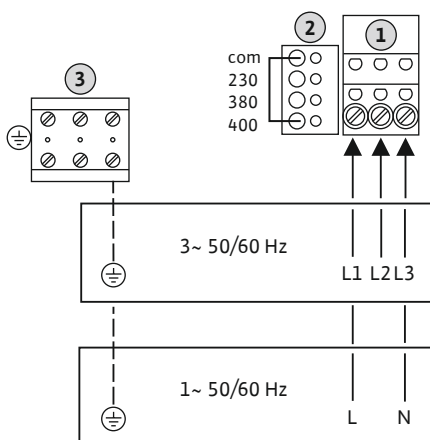

Fig. 9: Mains connection Wilo-Control EC-B 1.../EC-B 2...

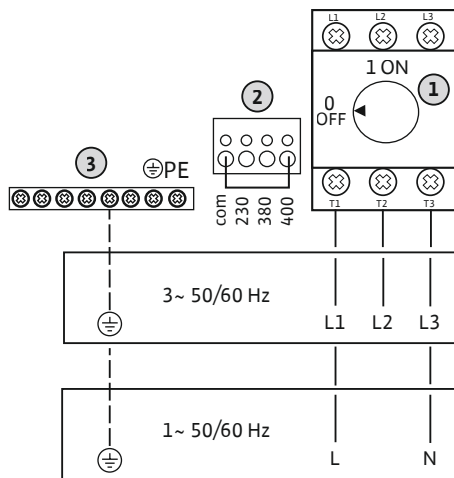

Fig. 10: Mains connection Wilo-Control EC-B 3...

#### 6.5.4 Switchgear mains connection: Control ECe-Booster 1~230 V

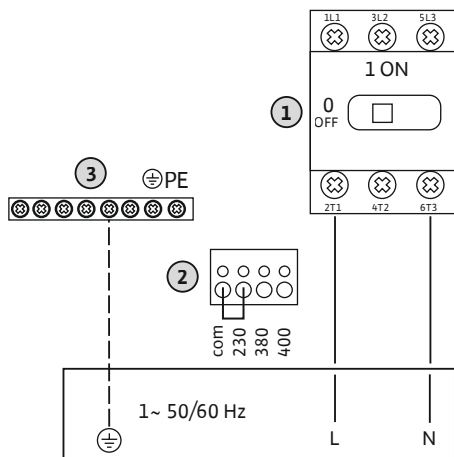

Fig. 11: Mains connection 1~230 V Wilo-Control ECe-B...

- Cable: 4-core
- Wire: L1, L2, L3, PE
- Mains voltage adjustment: Converter bridge 400/COM (factory setting)

#### Mains connection Wilo-Control EC-B 3 ...

1	Main switch
2	Mains voltage adjustment
3	Terminal strip: Earth (PE)

Insert the connection cables provided by the customer through the threaded cable glands and secure. Connect the wires to the main switch as per connection diagram.

#### Mains connection 1~230 V:

- Cable: 3-core
- Wire: L, N, PE
- Mains voltage adjustment: Converter bridge 230/COM

#### Mains connection 3~230 V:

- Cable: 4-core
- Wire: L1, L2, L3, PE
- Mains voltage adjustment: Converter bridge 230/COM

#### Mains connection 3~380 V:

- Cable: 4-core
- Wire: L1, L2, L3, PE
- Mains voltage adjustment: Converter bridge 380/COM

#### Mains connection 3~400 V:

- Cable: 4-core
- Wire: L1, L2, L3, PE
- Mains voltage adjustment: Converter bridge 400/COM (factory setting)



### NOTICE

#### Neutral conductor required

A neutral conductor is required at the mains connection for the correct functioning of the controls.

1	Main switch
2	Mains voltage adjustment
3	Terminal strip: Earth (PE)

Insert the connection cables provided by the customer through the threaded cable glands and secure. Connect the wires to the main switch as per connection diagram.

#### Mains connection 1~230 V:

- Cable: 3-core
- Wire: L, N, PE
- Mains voltage adjustment: Converter bridge 230/COM (factory setting)

### 6.5.5 Switchgear mains connection: Control ECe-Booster 3~400 V

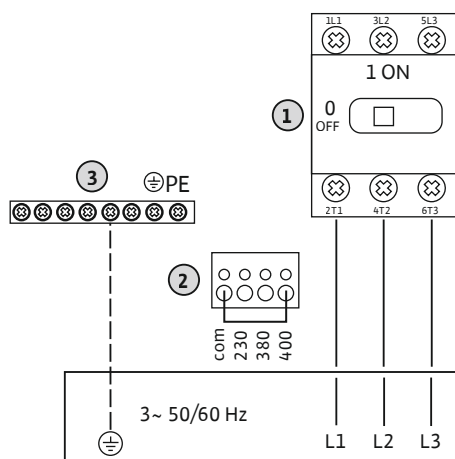

Fig. 12: Mains connection 3~400 V Wilo-Control ECe-B...

### 6.5.6 Mains connection: Fixed-speed pump

## CAUTION

### Risk of property damage due to incorrectly set mains voltage!

The switchgear can be operated at different mains voltages. However, the control voltage must always be 230 V. If the control voltage is set incorrectly, the control unit will be destroyed!

- The cable jumper is set to the correct control voltage as a factory setting.
- Do not change the cable bridge!



## NOTICE

### Neutral conductor required

A neutral conductor is required at the mains connection for the correct functioning of the controls.

1	Main switch
2	Mains voltage adjustment
3	Terminal strip: Earth (PE)

Insert the connection cables provided by the customer through the threaded cable glands and secure. Connect the wires to the main switch as per connection diagram.

#### Mains connection 3~380 V:

- Cable: 5-core
- Wire: L1, L2, L3, PE
- Mains voltage adjustment: Converter bridge 380/COM

#### Mains connection 3~400 V:

- Cable: 5-core
- Wire: L1, L2, L3, PE
- Mains voltage adjustment: Converter bridge 400/COM (factory setting)



## NOTICE

### Power supply and pump connection rotating field

The rotating field is routed from the mains connection directly to the pump connection.

- Check the required rotating field of the pumps to be connected (clockwise or counter-clockwise).
- Observe the installation and operating instructions of the pumps.

### 6.5.6.1 Connect pump(s)

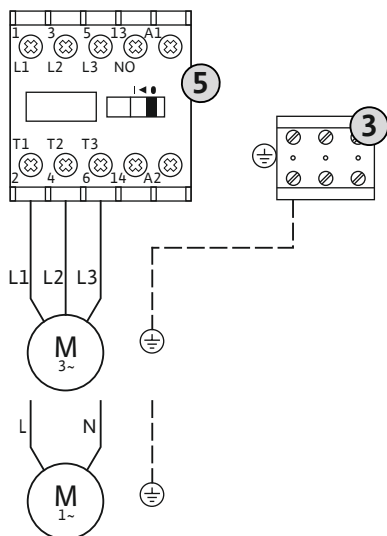

Fig. 13: Pump connection

### 6.5.6.2 Adjust motor current monitoring

3	Terminal strip: Earth (PE)
---	----------------------------

5	Contactur
---	-----------

Insert the connection cable laid by the customer through the threaded cable glands and secure. Connect the wires to the contactor as per the connection diagram.

**NOTICE! After all pumps have been connected, set the motor current monitoring!**

The **minimum and maximum** motor current of the connected pumps is monitored:

- Minimum motor current monitoring  
The value is permanently stored in the switchgear: 300 mA or 10% of the set motor current.

**NOTICE! Monitoring can be disabled in Menu 5.69.**

- Maximum motor current monitoring  
Adjust the value in the switchgear.

**NOTICE! Monitoring cannot be disabled!**

The maximum motor current is monitored in two different ways:

- Connected pumps with **rated current up to 12 A**: electronic motor current monitoring
- Connected pumps with **rated current greater than 12 A**: separate motor protection switch

**Motor current monitoring Wilo-Control EC-B ... for pumps with rated current up to 12 A**

After connecting the pumps, set the rated motor current of the pump.

8	Potentiometer for motor current monitoring
---	--

Use a screwdriver to set the rated motor current at the respective potentiometer.

**NOTICE! "0" setting on the potentiometer leads to an error when the pump is activated!**

Precise adjustment of motor current monitoring can be performed during commissioning. During commissioning, the set and the actual rated motor current can be shown on the display:

- Currently **set** value of the motor current monitoring (Menu 4.25 to 4.27)
- Currently **measured** operating current of the pump (Menu 4.29 to 4.31)

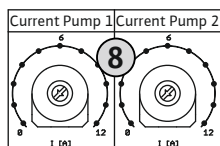

Fig. 14: Set the rated motor current at the potentiometer

**Motor current monitoring Wilo-Control EC-B ... for pumps with rated current greater than 12 A**

8	Motor protection switch
8.1	Potentiometer for motor current monitoring

After connecting the pumps, use a screwdriver to set the rated motor current on the respective motor protection switch.

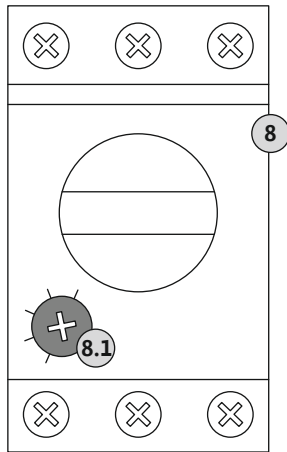

Fig. 15: Set the rated motor current at the motor protection switch

**6.5.7 Mains connection: Variable-speed pump (electronically controlled pumps)**

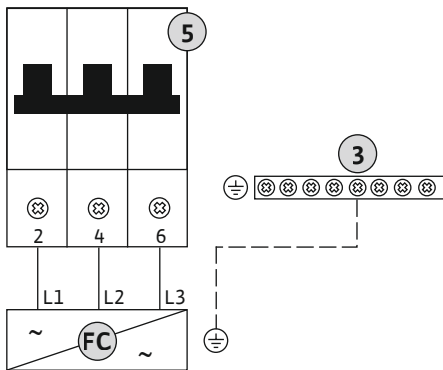

Fig. 16: Pump connection with 3-pole circuit breaker

3	Terminal strip: Earth (PE)
5	Circuit breaker 3-pole (3~) / 2-pole (1~)
FC	Frequency converter

Insert the connection cable laid by the customer through the threaded cable glands and secure. Connect the wires to the circuit breaker as per the connection diagram.

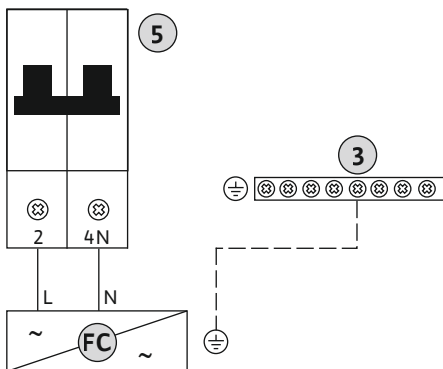

Fig. 17: Pump connection with 2-pole circuit breaker

**6.5.8 Connection, thermal motor monitoring**

**CAUTION**

**Property damage due to external voltage!**

An external voltage which is applied destroys the component.

- Do not apply external voltage.

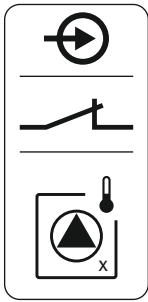

Fig. 18: Connection overview symbol

### 6.5.9 Connection to the frequency converter error messages

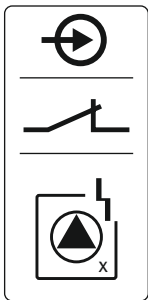

Fig. 19: Connection overview symbol

### 6.5.10 Pressure sensor connection

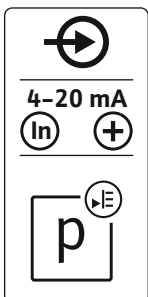

Fig. 20: Connection overview symbol

#### **NOTICE! Connection is only possible using the Wilo-Control EC-B ... switchgear!**

One thermal motor monitoring device with bimetallic sensors can be connected per pump. Do not connect PTC or Pt100 sensors!

The terminals are fitted with a converter bridge at the factory.

Insert the connection cables provided by the customer through the threaded cable glands and secure. Connect the wires to the terminal strip according to the connection diagram. **Use the terminal number shown in the connection overview on the cover.** The number shown in location "x" on the symbol indicates which pump it refers to:

- 1 = pump 1
- 2 = pump 2
- 3 = pump 3

---

### CAUTION

#### **Property damage due to external voltage!**

An external voltage which is applied destroys the component.

- Do not apply external voltage.
- 

#### **NOTICE! Connection is only possible using the Wilo-Control ECe-B ... switchgear!**

One external error message of the frequency converter can be connected per pump. The frequency converter output needs to act as a normally closed contact!

Insert the connection cable laid by the customer through the threaded cable glands and secure. Connect the wires to the terminal strip according to the connection diagram. **Use the terminal number shown in the connection overview on the cover.** The number shown in location "x" on the symbol indicates which pump it refers to:

- 1 = pump 1
- 2 = pump 2
- 3 = pump 3

---

### CAUTION

#### **Property damage due to external voltage!**

An external voltage which is applied destroys the component.

- Do not apply external voltage.
- 

Pressure detection is performed using an analogue pressure sensor (4 to 20 mA). **NOTICE! Do not attach an active pressure sensor.**

Insert the connection cables provided by the customer through the threaded cable glands and secure. Connect the wires to the terminal strip according to the connection diagram. **Use the terminal number shown in the connection overview on the cover.**

**NOTICE! Use shielded connection cables! Apply the shielding on one side!**

**NOTICE! Observe the correct polarity of the pressure sensor!**



### 6.5.11 Low water level connection (dry-running protection)

## CAUTION

### Property damage due to external voltage!

An external voltage which is applied destroys the component.

- Do not apply external voltage.

The low water level (dry-running protection) can also be monitored using a float or pressure switch and one or two electrodes:

- Float/pressure switch
- Electrode
  - **Only** Control EC-B/ECe-B 1x ... and EC-B/ECe-B 2x ...
  - Connection is protected against reverse polarity!

The input acts as a normally closed contact (NC):

- Float switch/pressure switch open or electrode non-immersed: min. water level
- Float switch/pressure switch closed or electrode immersed: water level sufficient

The terminals are fitted with a converter bridge at the factory.

Insert the connection cables laid by the customer through the threaded cable glands and secure. Remove the converter bridge and connect the wires to the terminal strip according to the connection diagram. **Use the terminal number shown in the connection overview on the cover.**

### Use of electrodes

If electrodes are used for level measurement, the connection can be made in the following ways:

A	1x electrode with reference earth on the tank
B	2x electrodes with reference earth via the electrode

Fig. 21: Connection overview symbol

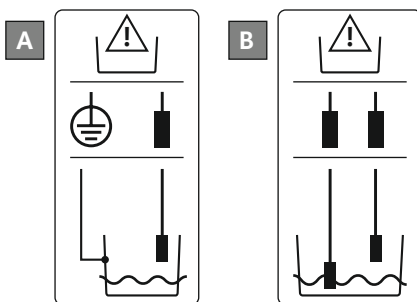

Fig. 22: Electrode connection types

### 6.5.12 “Extern OFF” connection: Remote deactivation

## CAUTION

### Property damage due to external voltage!

An external voltage which is applied destroys the component.

- Do not apply external voltage.

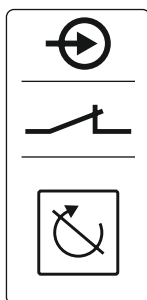

Fig. 23: Connection overview symbol

Remote deactivation of all pumps can be performed using a separate switch:

- Contact closed: pumps enabled
- Contact open: all pumps deactivated – the display shows the “Extern OFF” symbol.

The terminals are fitted with a converter bridge at the factory.

**NOTICE! Remote deactivation is prioritised. All pumps are deactivated regardless of their current pressure value. The pumps cannot be operated in manual mode!**

Insert the connection cables laid by the customer through the threaded cable glands and secure. Remove the converter bridge and connect the wires to the terminal strip according to the connection diagram. **Use the terminal number shown in the connection overview on the cover.**

### 6.5.13 Configured speed setpoint connection

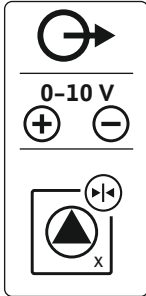

Fig. 24: Connection overview symbol

### 6.5.14 Collective run signal (SBM) connection

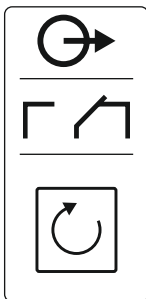

Fig. 25: Connection overview symbol

### 6.5.15 Collective fault signal connection (SSM)

## CAUTION

### Property damage due to external voltage!

An external voltage which is applied destroys the component.

- Do not apply external voltage.

### NOTICE! Connection is only possible using the Wilo-Control ECe-B switchgear!

The speed setpoint is issued through a separate output for each pump. A voltage of 0 – 10 V is provided for this at the output.

Insert the connection cable laid by the customer through the threaded cable glands and secure. Connect the wires to the terminal strip according to the connection diagram. **Use the terminal number shown in the connection overview on the cover.** The number shown in location “x” on the symbol indicates which pump it refers to:

- 1 = pump 1
- 2 = pump 2
- 3 = pump 3

**NOTICE! Use shielded connection cables! Apply the shielding on both sides!**



## DANGER

### Danger of death due to electrical current!

The external electrical power supply is also present at the terminals when the main switch is switched off!

- Disconnect the external power supply before any work.
- Electrical work must be carried out by a qualified electrician.
- Observe local regulations.

A run signal is issued for all pumps (SBM) via a separate output:

- Contact type: potential-free changeover contact
- Contact load:
  - Minimum: 12 V~, 10 mA
  - Maximum: 250 V~, 1 A
- Insert the connection cables laid by the customer through the threaded cable glands and secure.
- Connect the wires to the terminal strip according to the connection diagram.
- Use the terminal number shown in the connection overview on the switchgear cover.



## DANGER

### Danger of death due to electrical current!

The external electrical power supply is also present at the terminals when the main switch is switched off!

- Disconnect the external power supply before any work.
- Electrical work must be carried out by a qualified electrician.
- Observe local regulations.

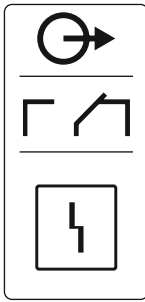

Fig. 26: Connection overview symbol

#### 6.5.16 Individual run signal (EBM) connection

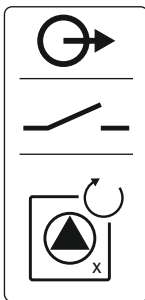

Fig. 27: Connection overview symbol

#### 6.5.17 Individual fault signal (ESM) connection

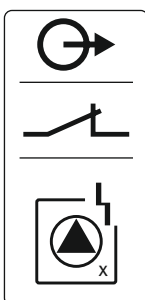

Fig. 28: Connection overview symbol

A fault message is output for all pumps (SSM) via a separate output:

- Contact type: potential-free changeover contact
- Contact load:
  - Minimum: 12 V=, 10 mA
  - Maximum: 250 V~ 1 A
- Insert the connection cables laid by the customer through the threaded cable glands and secure.
- Connect the wires to the terminal strip according to the connection diagram.
- Use the terminal number shown in the connection overview on the switchgear cover.



### DANGER

#### Danger of death due to electrical current!

The external electrical power supply is also present at the terminals when the main switch is switched off!

- Disconnect the external power supply before any work.
- Electrical work must be carried out by a qualified electrician.
- Observe local regulations.

A run signal is output for each pump (EBM) via a separate output:

- Contact type: potential-free NO contact
- Contact load:
  - Minimum: 12 V=, 10 mA
  - Maximum: 250 V~, 1 A

Insert the connection cables laid by the customer through the threaded cable glands and secure. Connect the wires to the terminal strip according to the connection diagram. **Use the terminal number shown in the connection overview on the cover.** The number shown in location "x" on the symbol indicates which pump it refers to:

- 1 = pump 1
- 2 = pump 2
- 3 = pump 3



### DANGER

#### Danger of death due to electrical current!

The external electrical power supply is also present at the terminals when the main switch is switched off!

- Disconnect the external power supply before any work.
- Electrical work must be carried out by a qualified electrician.
- Observe local regulations.

A fault message is output for each pump (ESM) via a separate output:

- Contact type: potential-free NC contact
- Contact load:
  - Minimum: 12 V=, 10 mA
  - Maximum: 250 V~, 1 A

Insert the connection cables laid by the customer through the threaded cable glands and secure. Connect the wires to the terminal strip according to the connection diagram. **Use the terminal number shown in the connection overview on the cover.** The number shown in location "x" on the symbol indicates which pump it refers to:

- 1 = pump 1
- 2 = pump 2
- 3 = pump 3

### 6.5.18 Low water level (dry-running protection) alarm connection

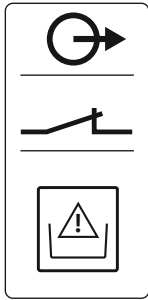

Fig. 29: Connection overview symbol

### 6.5.19 Connection ModBus RTU

Control EC/ECe-B2



Control EC/ECe-B3



Fig. 30: Jumper position



## DANGER

### Danger of death due to electrical current!

The external electrical power supply is also present at the terminals when the main switch is switched off!

- Disconnect the external power supply before any work.
- Electrical work must be carried out by a qualified electrician.
- Observe local regulations.

If the water level falls below the low water level, a fault message is generated via a separate output:

- Contact type: potential-free NC contact
- Contact load:
  - Minimum: 12 V<sub>~</sub>, 10 mA
  - Maximum: 250 V<sub>~</sub>, 1 A

Insert the connection cables laid by the customer through the threaded cable glands and secure. Connect the wires to the terminal strip according to the connection diagram. **Use the terminal number shown in the connection overview on the cover.**

## CAUTION

### Property damage due to external voltage!

An external voltage which is applied destroys the component.

- Do not apply external voltage.

See Overview of components: Wilo-Control EC-Booster [► 12] for position numbers

9	ModBus: RS485 interface
10	ModBus: Jumper for termination/polarisation

The ModBus protocol is available for connection to a building management system.

- Insert the connection cable laid by the customer through the threaded cable glands and secure.
- Connect the wires to the terminal strip according to the connection diagram.

Observe the following points:

- Interface: RS485
- Field bus protocol settings: Menu 2.01 to 2.05.
- The switchgear is terminated at the factory. Remove termination: Remove jumper "J2".
- If the ModBus requires a polarisation, plug in jumpers "J3" and "J4".

#### See also

- Overview of components: Wilo-Control EC-Booster [} 12]

## 7 Operation



## DANGER

### Danger of death due to electrical current!

There is danger of death from open switchgear.

- Only operate the switchgear when closed.
- Electrical work on the internal components must be carried out by a qualified electrician.

## 7.1 How it works

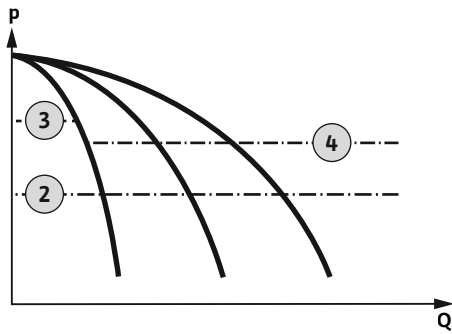

Fig. 31: Functional diagram for Control EC-Booster

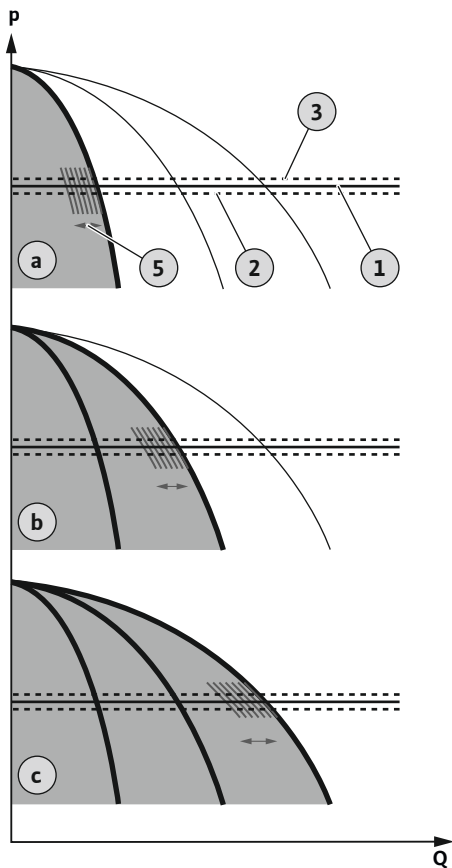

Fig. 32: Functional diagram for Control ECe-Booster

### 7.1.1 Pump cycling

#### Wilo-Control EC-Booster

2	Activation threshold
3	Deactivation threshold for base-load pump
4	Deactivation threshold for peak-load pumps

During normal operation, the system maintains a pressure in the range between the activation and deactivation thresholds. Control is carried out as two-position control. A pressure sensor measures the actual pressure value. If the pressure falls below the activation threshold, the base-load pump switches on. Depending on the power requirement, the peak-load pumps are activated one by one. If the deactivation threshold for the peak-load pumps is exceeded, the system turns off the peak-load pumps one by one. If the deactivation threshold for the base-load pump is exceeded, the system turns off the base-load pump. During operation, a visual indicator appears on the LCD display and the green LED lights up. To optimise pump running times, **pump cycling** is carried out regularly.

In the event of a fault, the system automatically switches to a different pump. The error code is shown on the LCD display and the red LED lights up. The outputs for the collective fault signal (SSM) and individual fault signal (ESM) are activated.

If the **low water level** in the break tank (dry-running protection) is reached, all pumps are switched off. The error code is shown on the LCD display and the red LED lights up. The output for the collective fault signal (SSM) is activated.

#### Wilo-Control ECe-Booster

a	1-pump operation
b	2-pump operation
c	3-pump operation
1	Reference setpoint
2	Activation threshold
3	Deactivation threshold
5	Load-sensitive speed control

During normal operation, the system maintains the pressure at the reference setpoint by comparing the setpoint and actual value. Control is provided by the load-sensitive speed control of the pumps. A pressure sensor measures the actual pressure value. If the pressure falls below the activation threshold, the first pump switches on and is used as the base-load pump with load-sensitive control. If the base-load pump cannot cover the power requirement at maximum speed, a second pump is switched on when the system falls below the reference setpoint. The second pump becomes the base-load pump with load-sensitive control. The previous base-load pump continues to run at maximum speed as a peak-load pump. This procedure is repeated as the power requirement increases until the maximum number of pumps has been reached.

When the power requirement decreases, the pump currently acting as base-load pump is switched off when it reaches its minimum speed and simultaneously exceeds the reference setpoint. A pump that was previously acting as a peak-load pump becomes the base-load pump and takes over the control. This process repeats as the power requirement decreases until only one pump remains working as a base-load pump. If the deactivation threshold for the base-load pump is exceeded, the system turns off the base-load pump. During operation, a visual indicator appears on the LCD display and the green LED lights up. To optimise pump running times, **pump cycling** is carried out regularly.

In the event of a fault, the system automatically switches to a different pump. The error code is shown on the LCD display and the red LED lights up. The outputs for the collective fault signal (SSM) and individual fault signal (ESM) are activated.

If the **low water level** in the break tank (dry-running protection) is reached, all pumps are switched off. The error code is shown on the LCD display and the red LED lights up. The output for the collective fault signal (SSM) is activated.

The base-load pump is regularly switched in order to prevent irregular running times of the individual pumps. When all pumps are switched off, the base-load pump will change the next time the system is activated.

Additionally, repeated pump cycling is activated as a factory setting. This causes the base-load pump to be switched every 6 hours. **NOTICE! To deactivate this function: Menu 5.60!**

- 7.1.2 Standby pump**
- One pump can be used as a standby pump. This pump is not activated during normal operation. The standby pump is only activated in the event of pump failure due to a fault. The standby pump is subject to standstill monitoring. The standby pump is therefore activated during pump cycling and pump kick.
- 7.1.3 Low water level (dry-running protection)**
- The water level in the break tank can be monitored and reported to the switchgear. Observe the following points:
- Contact type: NC contact
  - Low water: The pumps are switched off after the delay time has elapsed (Menu 5.64). The error code is shown in the LCD display.  
**NOTICE! If during the delay time the contact is closed again or the electrode is immersed again, there is no deactivation!**
  - Reactivation: When the contact has been closed and the delay time has elapsed (Menu 5.63), the system will start automatically.  
**NOTICE! The fault will be automatically reset, but it will be stored in the fault memory!**
- 7.1.4 Operation with a defective pressure sensor**
- If the pressure sensor does not transfer a measured value (e.g. due to a wire break or defective sensor), all pumps are switched off. Furthermore, the red LED fault signal lights up and the collective fault signal is activated.
- Emergency operation**
- To ensure water supply in the event of a fault, emergency operation can be activated:
- Menu 5.45
  - Number of active pumps
  - **NOTICE! Control ECe-Booster: The pumps are uncontrolled during emergency operation!**
- 7.1.5 Pump kick (cyclical test run)**
- To avoid longer periods of standstill for the activated pumps, a cyclical test run (pump kick function) is provided as a factory setting. **NOTICE! To deactivate this function: Menu 5.40!**
- Observe the following points for this function:
- **Menu 5.41:** Pump kick permitted in “Extern OFF”  
Start test run when the pumps are switched off using “Extern OFF”?
  - **Menu 5.42:** Pump kick interval  
Time interval after which a test run takes place. **NOTICE! The time interval will start when all pumps are switched off!**
  - **Menu 5.43:** Pump kick running time  
Pump running time during the test run
- 7.1.6 Zero-flow test**
- NOTICE! Function only available on the Wilo-Control ECe-B switchgear!**
- When only the base-load pump is being operated in the lower frequency range and at constant pressure, a zero-flow test will be carried out cyclically. To do this, the pressure setpoint is increased for a short period and then reset to the set value. If the system pressure does not decrease after the pressure setpoint has been reset, there is a zero flow. The base-load pump is switched off after the follow-up time has ended.
- The parameters for the zero-flow test are preset and cannot be altered. The zero-flow test is activated as a factory setting. **NOTICE! To deactivate this function: Menu 5.61!**
- 7.1.7 Minimum and maximum pressure monitoring**
- Maximum pressure monitoring**
- The overpressure monitoring is **always active**, i.e. the pressure in the system is continuously monitored. An alarm is triggered under the following conditions:
- The system pressure rises above the overpressure detection threshold (Menu 5.17, factory setting: 10 bar).
  - The delay time for overpressure and underpressure detection has expired (Menu 5.74, factory setting: 5 s).
- If the maximum pressure monitoring triggers an alarm, all pumps are deactivated. The error code is shown on the LCD display and the red LED lights up. The output for the collective fault signal (SSM) is activated.
- If the pressure falls below the overpressure detection threshold, the alarm is automatically reset after a short delay.

### Minimum pressure monitoring

The minimum pressure monitoring is deactivated at the factory (Menu 5.18, factory setting: 0 bar). As soon as a pump is running, the minimum pressure monitoring is active. **NO-TICE! To deactivate the minimum pressure monitoring, set the value in Menu 5.18 to “0 bar”.**

An alarm is triggered under the following conditions:

- The system pressure falls below the underpressure detection threshold (Menu 5.18, factory setting: 0 bar).
- The delay time for overpressure and underpressure detection has expired (Menu 5.74, factory setting: 5 s).

With underpressure monitoring, the system reaction can be set (Menu 5.73):

- The system continues to operate normally (factory setting). The error code is shown in the LCD display. The alarm is automatically acknowledged with a short delay when the pressure threshold is exceeded.
- The system triggers an alarm and all pumps are switched off. The error code is shown on the LCD display and the red LED lights up. The output for the collective fault signal (SSM) is activated. The alarm must be acknowledged manually.

## 7.2 Menu control

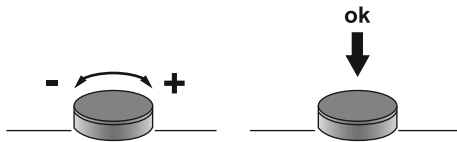

Fig. 33: Operating button function

## 7.3 Menu type: Main menu or Easy Actions menu

The menu is controlled via the operating button:

- **Turn:** Menu selection or settings values.
- **Press:** Change menu level, confirm error number or value.

There are two different menus.

- Main menu: Access to all settings for a complete configuration.
- Easy Actions menu: Quick access to certain functions.

Observe the following points when using the Easy Actions menu:

- The Easy Actions menu only offers access to the selected functions. It is not possible to perform a complete configuration with this.
- Perform an initial configuration to use the Easy Actions menu.
- The Easy Actions menu is enabled at the factory. Note, the Easy Actions menu can be **disabled in menu 7.06**.

## 7.4 Call up the menu

### Call up the main menu

1. Press operating button for 3 seconds.
  - ▶ Menu item 1.00 appears.







### Call up the Easy Actions menu

1. Turn operating button 180°.
  - ⇒ The “Resetting error messages” or “Manual operation pump 1” function appears
2. Turn operating button an additional 180°.
  - ▶ The other functions are shown. The main screen appears at the end.

## 7.5 Quick access to “Easy Actions”

The following functions can be called up using the Easy Actions menu:

	Reset the current error message <b>NOTICE! Menu point is only shown when an error is present!</b>
	<b>Manual operation pump 1</b> If the operating button is pressed, pump 1 runs. If the operating button is released, the pump switches off. The last set operating mode is active again.
	<b>Manual operation pump 2</b> If the operating button is pressed, pump 2 runs. If the operating button is released, the pump switches off. The last set operating mode is active again.

	<b>Manual operation pump 3</b> If the operating button is pressed, pump 3 runs. If the operating button is released, the pump switches off. The last set operating mode is active again.
	<b>Pump 1 switch off.</b> Corresponds to the “off” value in menu 3.02.
	<b>Pump 2 switch off.</b> Corresponds to the “off” value in menu 3.03.
	<b>Pump 3 switch off.</b> Corresponds to the “off” value in menu 3.04.
	<b>Automatic mode, pump 1</b> Corresponds to the “Auto” value in menu 3.02.
	<b>Automatic mode, pump 2</b> Corresponds to the “Auto” value in menu 3.03.
	<b>Automatic mode, pump 3</b> Corresponds to the “Auto” value in menu 3.04.

## 7.6 Factory settings

To reset the switchgear to the factory settings, contact customer service.

## 8 Commissioning

### 8.1 Operator responsibilities



#### NOTICE

##### Observe additional documentation

- Carry out the commissioning measures in accordance with the installation and operating instructions for the overall system.
- Observe the installation and operating instructions for the connected products (sensors and pumps) as well as the system documentation.

- Provide installation and operating instructions at the switchgear or at a place specially reserved for it.
- Make the installation and operating instructions available in a language the personnel can understand.
- Make sure that the installation and operating instructions have been read and understood by all personnel.
- The installation site of the switchgear is overflow-proof.
- The switchgear is properly fused and earthed.
- Safety devices and precautions (incl. emergency off) for the entire system are switched on and have been checked for problem-free operation.
- The switchgear is suitable for use under the specified operating conditions.

### 8.2 Activating the switchgear

#### 8.2.1 Possible error message during activation

**NOTICE! Rotating field monitoring and motor current monitoring are only available in the Wilo-Control EC-Booster!**

Depending on the mains connection and the basic settings, the following error message may occur during activation. The error codes listed and their description apply to commissioning. A complete overview can be found in Chapter “Error codes”.

Code*	Faults	Cause	Remedies
E006	Rotating field error	<ul style="list-style-type: none"> <li>• Incorrect rotating field</li> <li>• Operation with single-phase AC current connection.</li> </ul>	<ul style="list-style-type: none"> <li>• Establish a clockwise rotating field at the mains connection.</li> <li>• Deactivate rotating field monitoring (menu 5.68)!</li> </ul>



Code*	Faults	Cause	Remedies
E080.x	Pump fault	<ul style="list-style-type: none"> <li>No pump connected.</li> <li>Motor current monitoring not set.</li> </ul>	<ul style="list-style-type: none"> <li>Connect pump or deactivate minimum current monitoring (menu 5.69)!</li> <li>Set the motor current monitoring to the pump's rated current.</li> </ul>

**Key:**

\* "x" = represents the pump to which the fault shown applies.

### 8.2.2 Activating the device

**NOTICE****Observe the error code on the display**

If the red fault LED lights up or flashes, observe the error code on the display! If the error has been confirmed, the previous error will be stored in menu 6.02.

- ✓ Switchgear is closed.
  - ✓ Installation has been performed correctly.
  - ✓ All signal transmitters and consumers are connected and installed in the operating space.
  - ✓ If a low-water cut-out switchgear (dry-running protection) is available, the switching point has been correctly set.
  - ✓ Motor protection is preset according to the pump data ("Control EC-Booster" only).
1. Turn the main switch to the "ON" position.
  2. Switchgear starts.
    - All LEDs light up for 2 s.
    - The display illuminates and the start screen appears.
    - The standby symbol appears in the display.
- ▶ The switchgear is ready for operation. Start the initial configuration or automatic mode.

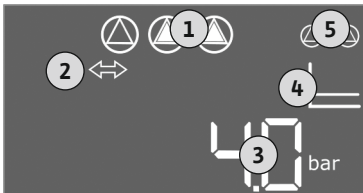

Fig. 34: Start screen

1	Current pump status: <ul style="list-style-type: none"> <li>– Number of registered pumps</li> <li>– Pump activated/deactivated</li> <li>– Pumps On/Off</li> </ul>
2	Fieldbus active
3	Actual pressure value
4	Control mode (e.g. p-c)
5	Standby pump function activated

### 8.3 Start initial configuration

Set the following parameters during initial configuration:

- Enable parameter input.
- Menu 5: Basic settings
- Menu 1: Activation/deactivation values
- Menu 2: Fieldbus connection (if available)
- Menu 3: Enable pumps.
- Set motor current monitoring.
- Check the direction of rotation of the connected pumps.

Observe the following points during the configuration:

- If there is no input or operation for 6 minutes:
  - the display illumination is switched off.
  - the display returns to the main screen.
  - parameter input is locked.
- Some settings can only be adjusted when there is no pump in operation.
- The menu is automatically adapted based on the settings. Example: The Menus 5.41 ... 5.43 are only visible when the "pump kick" function (Menu 5.40) is activated.
- The menu structure is valid for all EC switchgears (e.g. HVAC, Booster, Lift, Fire, etc.). This may lead to gaps in the menu structure.

### 8.3.1 Enable parameter input

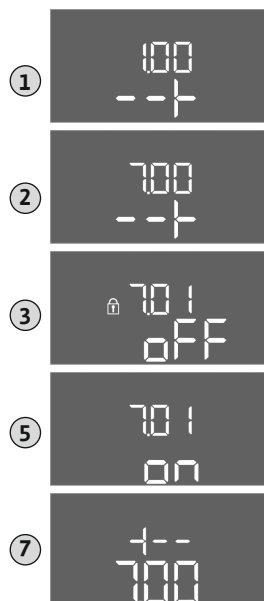

As standard, the values are only displayed. To change the values, the parameter input in Menu 7.01 must be enabled:

1. Press the operating button for 3 s.  
⇒ Menu item 1.00 appears
2. Turn the operating button until menu 7 appears.
3. Press the operating button.  
⇒ Menu 7.01 appears.
4. Press the operating button.
5. Change the value to “on”: Turn the operating button.
6. Save value: Press the operating button.  
⇒ The menu is enabled and can be changed.
7. Turn the operating button until the end of menu 7 appears.
8. Press the operating button.  
⇒ Back to the main menu level.  
▶ Start initial configuration.

Fig. 35: Enable parameter input

### 8.3.2 Overview of available parameters

The available parameters differ for the Control EC-B and Control ECe-B switchgear. The following table displays the differences.

Parameter (menu item)	Control EC-B up to 12 A	Control EC-B greater than 12 A	Control ECe-B
<b>1.00 Values for switching on and off</b>			
1.01 Pressure setpoint	•	•	•
1.04 Activation threshold of the pump in % of pressure setpoint	•	•	•
1.07 Deactivation threshold of the base-load pump in % of pressure setpoint	•	•	•
1.08 Peak-load pump deactivation threshold in % of pressure setpoint	•	•	–
1.09 Deactivation delay base-load pump	•	•	•
1.10 Activation delay peak-load pump	•	•	•
1.11 Deactivation delay peak-load pump	•	•	•
<b>2.00 Fieldbus connection for ModBus RTU</b>			
2.01 ModBus RTU interface On/Off	•	•	•
2.02 Baud rate	•	•	•
2.03 Standby pump address	•	•	•
2.04 Parity	•	•	•
2.05 Number of stop bits	•	•	•
<b>3.00 Enable pumps</b>			
3.01 Enable pumps	•	•	•
3.02 Pump 1 to Pump 3 operating mode	•	•	•
3.10 Running time of pumps in manual operation	•	•	•
3.11 Operating speed of pumps during manual operation	–	–	•
<b>4.00 Information</b>			
4.02 Current pressure value in bar	•	•	•
4.12 Running time of switchgear	•	•	•

Parameter (menu item)	Control EC-B up to 12 A	Control EC-B greater than 12 A	Control ECe-B
4.13 Running time: Pump 1	•	•	•
4.14 Running time: Pump 2	•	•	•
4.15 Running time: Pump 3	•	•	•
4.17 Switching cycles switchgear	•	•	•
4.18 Switching cycle: Pump 1	•	•	•
4.19 Switching cycle: Pump 2	•	•	•
4.20 Switching cycle: Pump 3	•	•	•
4.22 Serial number	•	•	•
4.23 Switchgear type	•	•	•
4.24 Software version	•	•	•
4.25 Set value for the motor current monitoring: Pump 1	•	–	–
4.26 Set value for the motor current monitoring: Pump 2	•	–	–
4.27 Set value for the motor current monitoring: Pump 3	•	–	–
4.29 Real-time current for pump 1 in A	•	–	–
4.30 Real-time current for pump 2 in A	•	–	–
4.31 Real-time current for pump 3 in A	•	–	–
<b>5.00 Basic settings</b>			
5.01 Control mode	•	•	•
5.02 Number of connected pumps	•	•	•
5.03 Standby pump	•	•	•
5.11 Pressure sensor measurement range	•	•	•
5.14 PID controller: Proportional factor	–	–	•
5.15 PID controller: Integral factor	–	–	•
5.16 PID controller: Differential factor	–	–	•
5.17 Overpressure detection threshold value	•	•	•
5.18 Underpressure detection threshold value	•	•	•
5.40 Switch “pump kick” function On/Off	•	•	•
5.41 “Pump kick” for External OFF allowed	•	•	•
5.42 “Pump kick interval”	•	•	•
5.43 “Pump kick duration”	•	•	•
5.45 Behaviour during sensor fault – number of pumps to be switched on	•	•	•
5.46 Minimum speed of the pumps	–	–	•
5.47 Maximum speed of the pumps	–	–	•
5.48 Acceleration ramp for frequency converter	–	–	•
5.49 Deceleration ramp for frequency converter	–	–	•
5.58 Collective run signal (SBM) function	•	•	•
5.59 Collective fault signal (SSM) function	•	•	•
5.60 Pump cycling	•	•	•
5.61 Zero-flow test	–	–	•
5.62 Low water level (dry-running protection): Deactivation delay	•	•	•
5.63 Low water level (dry-running protection): Reactivation time delay	•	•	•
5.68 Mains connection rotating field monitoring On/Off	•	–	–
5.69 Minimum motor current monitoring On/Off	•	–	–

Parameter (menu item)	Control EC-B up to 12 A	Control EC-B greater than 12 A	Control ECe-B
5.73 Reaction to underpressure detection	•	•	•
5.74 Delay time for overpressure and underpressure detection	•	•	•
5.79 Pump speed in the event of a sensor fault	-	-	•

### 8.3.3 Menu 5: Basic settings



Fig. 36: Menu 5.01



Fig. 37: Menu 5.02

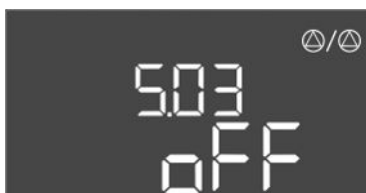

Fig. 38: Menu 5.03



Fig. 39: Menu 5.11



Fig. 40: Menu 5.14

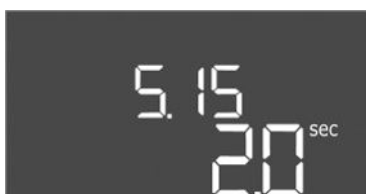

Fig. 41: Menu 5.15

Menu no.	5.01
Description	Control mode
Value range	P-c
Factory setting	Constant pressure control (p-c)

Menu no.	5.02
Description	Number of connected pumps
Value range	1 ... 3
Factory setting	3

Menu no.	5.03
Description	Standby pump
Value range	on, off
Factory setting	off
Explanation	<p>One pump can be used as a standby pump. This pump is not activated during normal operation. The standby pump is only activated in the event of pump failure due to a fault. The standby pump is subject to standstill monitoring. The standby pump is therefore activated during pump cycling and pump kick.</p> <ul style="list-style-type: none"> <li>on = Standby pump activated</li> <li>off = Standby pump deactivated</li> </ul>

Menu no.	5.11
Description	Pressure sensor measurement range
Value range	1 to 25 bar
Factory setting	16 bar

Menu no.	5.14
Description	PID controller: Proportional factor
Value range	0.1 to 100
Factory setting	5.0

Menu no.	5.15
Description	PID controller: Integral factor
Value range	0 to 300
Factory setting	2.0



Fig. 42: Menu 5.16



Fig. 43: Menu 5.17



Fig. 44: Menu 5.18



Fig. 45: Menu 5.40

Menu no.	5.16
Description	PID controller: Differential factor
Value range	0 to 300
Factory setting	0

Menu no.	5.17
Description	Overpressure detection threshold value
Value range	0.0 to 16.0 bar
Factory setting	10.0 bar
Explanation	<p>The overpressure monitoring is <b>always active</b>, i.e. the pressure in the system is continuously monitored. An alarm is triggered under the following conditions:</p> <ul style="list-style-type: none"> <li>• The system pressure rises above the set threshold.</li> <li>• The delay time for overpressure and underpressure detection has expired (menu 5.74).</li> </ul> <p><b>NOTICE! The value must be greater than the deactivation threshold in menu 1.07!</b></p>

Menu no.	5.18
Description	Threshold value for underpressure detection
Value range	0.0 to 16.0 bar
Factory setting	0.0 bar
Explanation	<p>As soon as a pump is running, the minimum pressure monitoring is active. An alarm is triggered under the following conditions:</p> <ul style="list-style-type: none"> <li>• The system pressure drops below the set threshold.</li> <li>• The delay time for overpressure and underpressure detection has expired (menu 5.74).</li> </ul> <p>Menu 5.73 is used to set how the system reacts in case of an alarm.</p> <ul style="list-style-type: none"> <li>• <b>NOTICE! To deactivate the minimum pressure monitoring, set the value to “0 bar”.</b></li> <li>• <b>WARNING! The value must be less than the activation threshold in menu 1.04!</b></li> </ul>

Menu no.	5.40
Description	Switch “pump kick” function On/Off
Value range	off, on
Factory setting	on
Explanation	<p>To prevent longer standstill times for the connected pumps, a periodical test run can be performed (pump kick function):</p> <ul style="list-style-type: none"> <li>• off = pump kick deactivated</li> <li>• on = pump kick activated</li> </ul> <p>If the pump kick function is activated, the following menu items can be set:</p> <ul style="list-style-type: none"> <li>• Menu 5.41: Allows “pump kick” when status is Extern OFF</li> <li>• Menu 5.42: Pump kick interval</li> <li>• Menu 5.43: Pump kick duration</li> </ul>



Fig. 46: Menu 5.41



Fig. 47: Menu 5.42

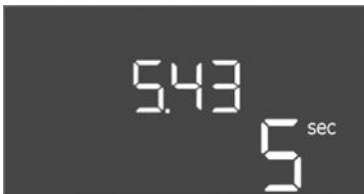

Fig. 48: Menu 5.43



Fig. 49: Menu 5.45

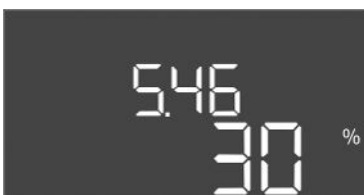

Fig. 50: Menu 5.46

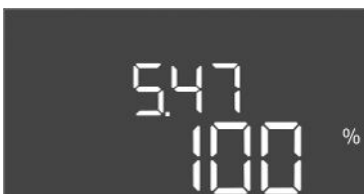

Fig. 51: Menu 5.47

Menu no.	5.41
Description	Allows "pump kick" when status is Extern OFF
Value range	off, on
Factory setting	on
Explanation	Select whether a pump kick may take place or not if the Extern OFF input is active: <ul style="list-style-type: none"> <li>• off = pump kick deactivated if Extern OFF is active.</li> <li>• on = pump kick activated if Extern OFF is active.</li> </ul>

Menu no.	5.42
Description	"Pump kick interval"
Value range	1 ... 336 h
Factory setting	24 h
Explanation	Time after which a pump kick takes place.

Menu no.	5.43
Description	"Pump kick duration"
Value range	0 ... 60 s
Factory setting	5 s
Explanation	How long a pump kick runs for a pump.

Menu no.	5.45
Description	Behaviour during sensor fault – number of pumps to be switched on
Value range	0 to 3*
Factory setting	0
Explanation	* Maximum value dependent on number of pumps set (Menu 5.02).

Menu no.	5.46
Description	Minimum speed of the pumps
Value range	0 to 50%
Factory setting	30%

Menu no.	5.47
Description	Maximum pump speed
Value range	80 to 100%
Factory setting	100%

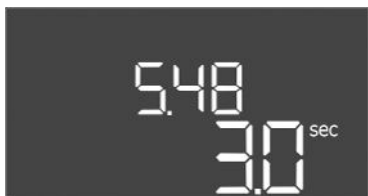

Fig. 52: Menu 5.48

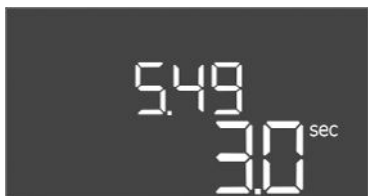

Fig. 53: Menu 5.49



Fig. 54: Menu 5.58



Fig. 55: Menu 5.59

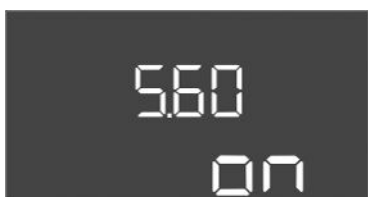

Fig. 56: Menu 5.60

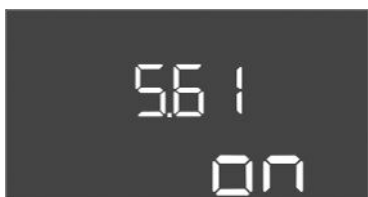

Fig. 57: Menu 5.61

Menu no.	5.48
Description	Acceleration ramp for frequency converter
Value range	0 to 10 s
Factory setting	3 s

Menu no.	5.49
Description	Deceleration ramp for frequency converter
Value range	0 to 10 s
Factory setting	3 s

Menu no.	5.58
Description	Collective run signal (SBM) function
Value range	on, run
Factory setting	run
Explanation	<p>A run signal for the switchgear or attached pump can be sent via a separate output:</p> <ul style="list-style-type: none"> <li>• “on”: Switchgear ready for operation</li> <li>• “run”: At least one pump is running.</li> </ul>

Menu no.	5.59
Description	Collective fault signal (SSM) function
Value range	fall, raise
Factory setting	raise
Explanation	<p>In case of an error, a general fault message can be sent via a separate output:</p> <ul style="list-style-type: none"> <li>• “fall”: The relay drops out. Optionally, this function can be used for controlling the mains voltage supply.</li> <li>• “raise”: The relay picks up.</li> </ul>

Menu no.	5.60
Description	Pump cycling
Value range	on, off
Factory setting	on

Menu no.	5.61
Description	Zero-flow test
Value range	on, off
Factory setting	on



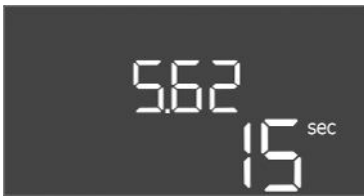

Fig. 58: Menu 5.62



Fig. 59: Menu 5.63

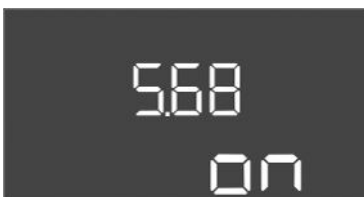

Fig. 60: Menu 5.68

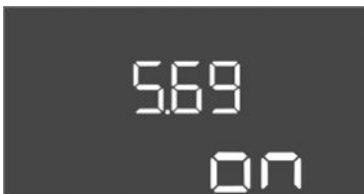

Fig. 61: Menu 5.69

Menu no.	5.62
Description	Low water level (dry-running protection): Deactivation delay
Value range	0 ... 180 s
Factory setting	15 s
Explanation	Time until the pumps are deactivated after reaching the low water level.

Menu no.	5.63
Description	Low water level (dry-running protection): Reactivation time delay
Value range	0 to 1800 s
Factory setting	10 s
Explanation	Time until the pumps are activated after exceeding the low water level.

Menu no.	5.68 (only Control EC-Booster up to 12 A)
Description	Mains connection rotating field monitoring On/Off
Value range	on, off
Factory setting	on
Explanation	<p>Integrated rotating field monitoring for the mains connection. If no clockwise rotating field is present, an error message occurs.</p> <ul style="list-style-type: none"> <li>off = rotating field monitoring deactivated</li> <li>on = rotating field monitoring activated</li> </ul> <p><b>NOTICE! When operating the switchgear via a single-phase current connection, switch off this function!</b></p>

Menu no.	5.69 (only Control EC-Booster up to 12 A)
Description	<b>Minimum</b> motor current monitoring On/Off
Value range	on, off
Factory setting	on
Explanation	<p>The motor current monitoring keeps track on the minimum and maximum motor current of the pump:</p> <ul style="list-style-type: none"> <li>Monitoring the minimum motor current The value is permanently set in the switchgear: 300 mA or 10% of the set maximum motor current. If no current is measured when the pump is activated, the motor current monitoring outputs an error.</li> <li>Monitoring the maximum motor current The integrated motor current monitoring outputs an error if the set motor current is exceeded.</li> </ul> <p>This function can be set as follows:</p> <ul style="list-style-type: none"> <li>on = motor current monitoring activated.</li> <li>off = motor current monitoring of the <b>minimum</b> motor current deactivated.</li> </ul> <p><b>NOTICE! Monitoring the maximum motor current cannot be deactivated!</b></p>



Fig. 62: Menu 5.73



Fig. 63: Menu 5.74



Fig. 64: Menu 5.79

Menu no.	5.73
Description	Reaction to underpressure detection
Value range	off, Cont
Factory setting	Cont
Explanation	<ul style="list-style-type: none"> <li>Cont: The system continues to operate normally. The error code is shown in the LCD display.</li> <li>off: The system triggers an alarm and all pumps are switched off. The error code is shown on the LCD display and the red LED lights up. The output for the collective fault signal (SSM) is activated.</li> </ul>

Menu no.	5.74
Description	Delay time for overpressure and underpressure detection
Value range	0 ... 60 s
Factory setting	1 s
Explanation	If the threshold value for the overpressure is exceeded or the threshold value for the underpressure is not reached, an alarm is only triggered after the set time has elapsed.

Menu no.	5.79
Description	Pump speed in the event of a sensor fault
Value range	0 to 100%
Factory setting	100%
Explanation	If it is set in Menu 5.45 that pumps are activated in case of a sensor error, the corresponding speed can be defined here.

### 8.3.4 Menu 1: Values for switching on and off



Fig. 65: Menu 1.01



Fig. 66: Menu 1.04



Fig. 67: Menu 1.07



Fig. 68: Menu 1.08



Fig. 69: Menu 1.09



Fig. 70: Menu 1.10

Menu no.	1.01
Description	Pressure setpoint
Value range	0.1 ... 25.0* bar
Factory setting	4 bar
Explanation	* The maximum value is dependent on the set measurement range of the pressure sensor (Menu 5.11).

Menu no.	1.04
Description	Activation threshold of the pump in % of the pressure setpoint
Value range	75 ... 99%
Factory setting	95 %

Menu no.	1.07
Description	Base-load pump deactivation threshold in % of pressure setpoint
Value range	101 ... 125%
Factory setting	115 %

Menu no.	1.08
Description	Peak-load pump deactivation threshold in % of pressure setpoint
Value range	101 ... 125%
Factory setting	110 %

Menu no.	1.09
Description	Base-load pump deactivation delay
Value range	0 ... 180 s
Factory setting	10 s
Explanation	Time until the base-load pump is switched off when the deactivation threshold is reached.

Menu no.	1.10
Description	Peak-load pump activation delay
Value range	0 ... 30 s
Factory setting	3 s
Explanation	Time until the peak-load pump is switched on when the activation threshold is reached.

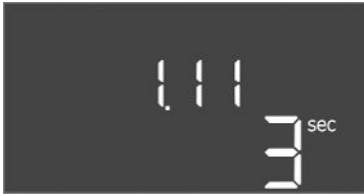

Fig. 71: Menu 1.11

### 8.3.5 Menu 2: ModBus RTU connection

The switchgear is equipped with an RS485 interface for connection via ModBus RTU. Different parameters can be read and also changed to some extent via the interface. In this case, the switchgear works as a Modbus slave. An overview of individual parameters and a description of the data types used are shown in the appendix.

To use the ModBus interface, the settings must be changed in the following menus:



Fig. 72: Menu 2.01



Fig. 73: Menu 2.02



Fig. 74: Menu 2.03



Fig. 75: Menu 2.04

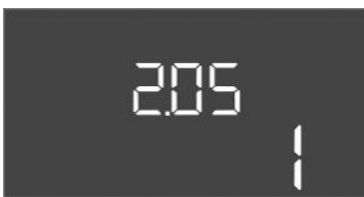

Fig. 76: Menu 2.05

Menu no.	1.11
Description	Peak-load pump switch-off delay
Value range	0 ... 30 s
Factory setting	3 s
Explanation	Time until the peak-load pump is switched off when the deactivation threshold is reached.

Menu no.	2.01
Description	ModBus RTU interface On/Off
Value range	on, off
Factory setting	off

Menu no.	2.02
Description	Baud rate
Value range	9600; 19200; 38400; 76800
Factory setting	19200

Menu no.	2.03
Description	Slave address
Value range	1 ... 254
Factory setting	10

Menu no.	2.04
Description	Parity
Value range	none, even, odd
Factory setting	even

Menu no.	2.05
Description	Number of stop bits
Value range	1; 2
Factory setting	1

### 8.3.6 Menu 3: Enable pumps



Fig. 77: Menu 3.02



Fig. 78: Menu 3.01



Fig. 79: Menu 3.10



Fig. 80: Menu 3.11

To operate the system, the operating mode must be set for each pump and the pumps enabled:

- Every pump is set to the “auto” operating mode as the factory setting.
- Automatic mode starts after the pumps have been enabled in Menu 3.01.

#### Required settings for the initial configuration

Carry out the following work during initial configuration:

- Check direction of rotation of the pumps
- Set precise motor current monitoring (“Control EC-Booster” only)

Use the following settings to perform the initial configuration:

- Switch off the pumps: Set menu 3.02 to 3.04 to “off”.
- Enable pumps: Set menu 3.01 to “on”.

Menu no.	3.02 ... 3.04
Description	Pump 1 ... Pump 3 operating mode
Value range	off, Hand, Auto
Factory setting	Auto
Explanation	<ul style="list-style-type: none"> <li>• off = pump switched off</li> <li>• Hand = manual operation of pump. Operation time and operation speed are set in Menu 3.10 and 3.11.</li> <li>• Auto = automatic operation of the pump depending on the pressure control</li> </ul> <p><b>NOTICE! Change the value to “off” for the initial configuration!</b></p>

Menu no.	3.01
Description	Enable pumps
Value range	on, off
Factory setting	off
Explanation	<ul style="list-style-type: none"> <li>• off = pumps are locked and cannot be started. <b>NOTICE! Manual operation or forced switch-on are also not possible!</b></li> <li>• on = pumps are switched on/off, depending on the operating mode set</li> </ul>

Menu no.	3.10
Description	Running time of pumps in manual operation
Value range	0 to 999 s
Factory setting	0 s
Explanation	<p>0 s: The pump runs in manual mode as long as the button is pressed and then switches back to the previous mode.</p> <p>1 to 998 s: The pump runs in manual mode for the specified amount of time.</p> <p>999 s: The pump runs in manual mode until the mode is changed again.</p> <p>The corresponding speed is set in Menu 3.11.</p>

Menu no.	3.11
Description	Operating speed of pumps during manual operation
Value range	0 to 100%
Factory setting	100%
Explanation	In manual operation, the pumps run at the set speed.

### 8.3.7 Set motor current monitoring (only Control EC-B up to 12 A)

#### Indicate the real-time value of the motor current monitoring

1. Press the operating button for 3 s.  
⇒ Menu 1.00 appears.
2. Turn the operating button until menu 4.00 appears.
3. Press the operating button.  
⇒ Menu 4.01 appears.
4. Turn the operating button until menu 4.25 to 4.27 appears.  
⇒ Menu 4.25: Shows the set motor current for pump 1.  
⇒ Menu 4.26: Shows the set motor current for pump 2.  
⇒ Menu 4.27: Shows the set motor current for pump 3.  
▶ Real-time value of the motor current monitoring has been checked.  
Compare the set value with the specification on the rating plate. If the set value differs from the specification on the rating plate, adjust the value.

#### Adjust the motor current monitoring value



#### DANGER

##### Risk of fatal injury due to electrical current!

There is a risk of fatal injury when performing work on the open switchgear! The components carry current!

- Have work carried out by a qualified electrician.
- Avoid contact with earthed metal parts (pipes, frames etc.).

- ✓ Motor current monitoring settings checked.
1. Turn the operating button until menu 4.25 to 4.27 appears.  
⇒ Menu 4.25: Shows the set motor current for pump 1.  
⇒ Menu 4.26: Shows the set motor current for pump 2.  
⇒ Menu 4.27: Shows the set motor current for pump 3.
  2. Open the switchgear.
  3. Correct the motor current on the potentiometer with a screwdriver (see Overview of components"). Read changes directly off the display.
  4. Once all of the motor currents have been corrected, close the switchgear.  
▶ Motor current monitoring set. Perform direction of rotation check.

### 8.3.8 Check the direction of rotation of the connected pumps



#### NOTICE

##### Power supply and pump connection rotating field

The rotating field is routed from the mains connection directly to the pump connection.

- Check the required rotating field of the pumps to be connected (clockwise or counter-clockwise).
- Observe the installation and operating instructions of the pumps.

Perform a test run to check the direction of rotation of the pumps. **CAUTION! Property damage! Perform the test run under the prescribed operating conditions.**

- ✓ The switchgear is closed.
  - ✓ Configuration of menu 5 and menu 1 complete.
  - ✓ All pumps are switched off in menu 3.02 to 3.04: Value is "off".
  - ✓ The pumps are enabled in menu 3.01: Value is "on".
1. Start Easy Actions menu: Turn the operating button 180°.
  2. Select the pump's manual operation mode: turn the operating button until the menu item is displayed:  
– Pump 1: P1 Hand

- Pump 2: P2 Hand
  - Pump 3: P3 Hand
3. Start test run: Press the operating button. Pump runs for the set time (Menu 3.10) and then switches off again.
  4. Check direction of rotation.
    - ⇒ **Incorrect direction of rotation:** Exchange two phases on the pump connection.
    - ▶ Direction of rotation checked and corrected as necessary. The initial configuration is complete.

#### 8.4 Start automatic mode

##### Automatic mode after initial configuration

- ✓ The switchgear is closed.
  - ✓ Configuration complete.
  - ✓ Direction of rotation correct.
  - ✓ Motor current monitoring set correctly.
1. Start Easy Actions menu: Turn the operating button 180°.
  2. Select the pump for automatic mode: Turn the operating button until the menu item is displayed:
    - Pump 1: P1 Auto
    - Pump 2: P2 Auto
    - Pump 3: P3 Auto
  3. Press the operating button.
    - ⇒ Automatic mode is set for the selected pump. Alternatively, setting can be performed in Menu 3.02 to 3.04.
    - ▶ Automatic mode switched on.

##### Automatic mode after shutdown

- ✓ The switchgear is closed.
  - ✓ Checked configuration.
  - ✓ Parameter input enabled: Menu 7.01 shows on.
1. Press the operating button for 3 s.
    - ⇒ Menu 1.00 appears.
  2. Turn the operating button until menu 3.00 appears
  3. Press the operating button.
    - ⇒ Menu 3.01 appears.
  4. Press the operating button.
  5. Change value to “on”.
  6. Press the operating button.
    - ⇒ Value saved, pump enabled.
    - ▶ Automatic mode switched on.

#### 8.5 During operation

Make sure the following points are observed during operation:















- Keep the switchgear closed and secure it against unauthorised opening.
- Switchgear attached in an overflow-proof manner (protection class IP54).
- Not exposed to direct sunlight.
- Ambient temperature: 0 ... 40 °C.

The following items of information are shown on the main screen:



- Pump status:
  - Number of registered pumps
  - Pump activated/deactivated
  - Pump On/Off
- Operation with standby pump
- Control mode
- Actual pressure value
- Active field bus operation

Furthermore, the following information is available via menu 4:

1. Press the operating button for 3 s.  
⇒ Menu 1.00 appears.
2. Turn the operating button until menu 4 appears.
3. Press the operating button.  
▶ Menu 4.xx appears.

	Actual pressure value in bar
	Switchgear running time The time will be displayed in minutes (min), hours (h) or days (d) depending on the unit.
	Running time: Pump 1 The time is stated in minutes (min), hours (h) or days (d) depending on the unit. The display varies depending on the timespan: <ul style="list-style-type: none"> <li>• 1 hour: Display in 0 ... 59 minutes, unit: min</li> <li>• 2 hours to 24 hours: Display in hours and minutes separated by a decimal point, e.g. 10.59, unit: h</li> <li>• 2 days to 999 days: Display in days and hours separated by a decimal point, e.g. 123.7, unit: d</li> <li>• From 1000 days: Display in days, unit: d</li> </ul>
	Running time: Pump 2 The time is stated in minutes (min), hours (h) or days (d) depending on the unit.
	Running time: Pump 3 The time is stated in minutes (min), hours (h) or days (d) depending on the unit.
	Switchgear switching cycles
	Switching cycles: Pump 1
	Switching cycles: Pump 2
	Switching cycles: Pump 3
	Serial number Display switches between the 1st and 2nd four digits.
	Switchgear type
	Software version
	Set value for the motor current monitoring: Pump 1 Max. rated current in A ("Control EC-Booster" only)
	Set value for the motor current monitoring: Pump 2 Max. rated current in A ("Control EC-Booster" only)
	Set value for the motor current monitoring: Pump 3 Max. rated current in A ("Control EC-Booster" only)



	<p>Actual current for pump 1 in A Display alternates between L1, L2 and L3 Press and hold the operating button. The pump starts after 2 s of pumping operation until the operating button is released. ("Control EC-Booster" only)</p>
	<p>Actual current for pump 2 in A Display alternates between L1, L2 and L3 Press and hold the operating button. The pump starts after 2 s of pumping operation until the operating button is released. ("Control EC-Booster" only)</p>
	<p>Actual current for pump 3 in A Display alternates between L1, L2 and L3 Press and hold the operating button. The pump starts after 2 s of pumping operation until the operating button is released. ("Control EC-Booster" only)</p>

## 9 Shut-down

### 9.1 Personnel qualifications

- Electrical work: qualified electrician  
Person with appropriate technical training, knowledge and experience who can identify and prevent electrical hazards.
- Installation/dismantling work: qualified electrician  
Knowledge regarding tools and fixation material for various structures

### 9.2 Operator responsibilities

- Observe locally applicable accident prevention and safety regulations of trade associations.
- Make sure that the personnel has had the corresponding training for the specified work.
- Train the personnel on how the system operates.
- When working in enclosed spaces, a second person must be present for safety reasons.
- Ensure enclosed spaces have sufficient ventilation.
- Take immediate countermeasures if there is a build-up of toxic or suffocating gases!

### 9.3 Shut-down

To decommission the pumps, switch off the pumps and switchgear at the main switch. The settings are stored in non-volatile memory in the switchgear and are not deleted. This ensures that the switchgear is always ready for operation. Adhere to the following points during the standstill period:

- Ambient temperature: 0 ... 40 °C
  - Max. humidity: 90 %, non-condensing
  - ✓ Parameter input enabled: Menu 7.01 shows on.
1. Press the operating button for 3 s.  
⇒ Menu 1.00 appears.
  2. Turn the operating button until menu 3.00 appears
  3. Press the operating button.  
⇒ Menu 3.01 appears.
  4. Press the operating button.
  5. Change value to "off".
  6. Press the operating button.  
⇒ Value saved, pump switched off.
  7. Turn main switch to the "OFF" position.
  8. Secure the main switch against being activated by unauthorised persons (e.g. lock main switch)
    - ▶ Switchgear switched off.

## 9.4 Removal



### DANGER

#### Risk of fatal injury due to electrical current!

Improper conduct when carrying out electrical work can lead to death due to electric shock!

- Electrical work must be carried out by a qualified electrician!
- Observe local regulations!

- ✓ Decommissioning performed.
  - ✓ Mains connection is switched so that it is voltage-free and safeguarded against being activated by unauthorised persons.
  - ✓ The power connection for fault and run signals is switched so that it is voltage-free and safeguarded against being activated by unauthorised persons.
1. Open the switchgear.
  2. Disconnect all connection cables and pull them out through the threaded cable connection.
  3. Close off the ends of the connection cables watertight.
  4. Seal threaded cable connections watertight.
  5. Support the switchgear (e.g. get a second person to help).
  6. Loosen the switchgear fastening screws and remove the switchgear from the structure.
    - ▶ Switchgear removed. Observe the following for storage!

## 10 Maintenance



### DANGER

#### Risk of fatal injury due to electrical current!

Improper conduct when carrying out electrical work can lead to death due to electric shock!

- Electrical work must be carried out by a qualified electrician!
- Observe local regulations!



### NOTICE

#### Unauthorised work or structural changes are prohibited!

Only maintenance and repair work described in this manual may be carried out. All other works and any alterations to the construction may only be carried out by the manufacturer.

### 10.1 Maintenance intervals

#### Regular

- Clean switchgear.

#### Annually

- Check electro-mechanical components for wear.

#### After 10 years

- General overhaul

### 10.2 Maintenance tasks

#### Cleaning switchgear

- ✓ Switch off switchgear.

1. Clean switchgear with a damp cotton cloth.

**Do not use any aggressive or scouring cleaners or fluids!**

#### Check electro-mechanical components for wear

- Have electro-mechanical components checked for wear by an electrician.
- If wear is ascertained, have the affected components replaced by an electrician or by the Wilo Customer Service.

## General overhaul

During a general overhaul, all of the components, wiring and the housing are checked for wear. Defective or worn components are replaced.

## 11 Faults, causes and remedies



### DANGER

#### Risk of fatal injury due to electrical current!

Improper conduct when carrying out electrical work can lead to death due to electric shock!

- Electrical work must be carried out by a qualified electrician!
- Observe local regulations!

### 11.1 Operator responsibilities

- Observe locally applicable accident prevention and safety regulations of trade associations.
- Make sure that the personnel has had the corresponding training for the specified work.
- Train the personnel on how the system operates.
- When working in enclosed spaces, a second person must be present for safety reasons.
- Ensure enclosed spaces have sufficient ventilation.
- Take immediate countermeasures if there is a build-up of toxic or suffocating gases!

### 11.2 Fault indication

Possible faults are shown by the fault LEDs and alphanumeric codes on the display.

- Have the system checked according to the displayed fault.
- Have the defective components replaced.

Faults are displayed in various ways:

- Fault in the control/on the switchgear:
  - The red fault signal LED **lights up**.  
The red fault signal LED **flashes**: Error message only occurs after a set time (e.g. dry-running protection with deactivation delay).
  - Display of the error code alternates with the main screen. The error code is stored in the fault memory.
  - The collective fault signal is activated.
- Pump fault  
**Status icon** of the respective pump **flashes** on the display.

### 11.3 Fault acknowledgement

Switch off the alarm display by pressing the operating button. Acknowledge the fault via the main menu or Easy Actions menu.

#### Main menu

- ✓ All faults rectified.
1. Press the operating button for 3 s.  
⇒ Menu 1.00 appears.
  2. Turn the operating button until menu 6 appears.
  3. Press the operating button.  
⇒ Menu 6.01 appears.
  4. Press the operating button.
  5. Change the value to "reset": Turn the operating button.
  6. Press the operating button.  
▶ The fault indication is reset.

#### Easy Actions menu

- ✓ All faults rectified.
1. Starting the Easy Actions menu: Turn the operating button 180°.
  2. Select menu item "Err reset".
  3. Press the operating button.  
▶ The fault indication is reset.

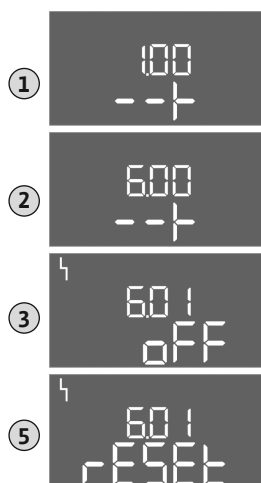

Fig. 81: Acknowledge fault

### Fault acknowledgement failed

If there are further faults, the faults are displayed as follows:

- The fault LED lights up.
- The error code of the last fault is shown in the display.  
All other faults can be called up from the fault memory.

If all faults have been rectified, acknowledge the faults again.

#### 11.4 Fault memory

The switchgear stores the last ten faults in the fault memory. The fault memory works according to the first in/first out principle. The faults are displayed in descending order in the menu items 6.02 to 6.11:

- 6.02: the last/latest fault
- 6.11: the oldest fault

#### 11.5 Error codes

The functions may operate differently depending on the software version. That is why a software version is included with every error code.

The details regarding the software version used can be read on the rating plate or displayed via menu 4.24.

Code*	Faults	Cause	Remedies
E006	Rotating field error	<ul style="list-style-type: none"> <li>• Incorrect rotating field</li> <li>• Operation via single-phase current connection</li> </ul>	<ul style="list-style-type: none"> <li>• Establish a clockwise rotating field at the mains connection.</li> <li>• Deactivate rotating field monitoring (menu 5.68)!</li> </ul>
E040	Pressure sensor fault	No response from sensor	Check the connection cable and sensor. Replace the defective component.
E060	System overpressure	...	<ul style="list-style-type: none"> <li>• Check threshold and correct if necessary (Menu 5.17).</li> <li>• ...</li> </ul>
E061	System underpressure	...	<ul style="list-style-type: none"> <li>• Check threshold and correct if necessary (Menu 5.18).</li> <li>• ...</li> </ul>
E062	Low water level (dry-running protection) active	Min. water level, below minimum value	<ul style="list-style-type: none"> <li>• Check inlet and system parameters.</li> <li>• Check that the sensor is working correctly, replace the defective component.</li> </ul>
E080.x	Control EC-Booster: Pump fault**	<ul style="list-style-type: none"> <li>• No pump connected.</li> <li>• Motor current monitoring not set (potentiometer is at "0")</li> <li>• No feedback from the corresponding contactor.</li> <li>• Thermal motor monitoring (bimetallic sensor) triggered.</li> <li>• Motor current monitoring triggered.</li> </ul>	<ul style="list-style-type: none"> <li>• Connect pump or deactivate minimum current monitoring (menu 5.69)!</li> <li>• Set the motor current monitoring to the pump's motor current.</li> <li>• Check functionality of pump.</li> <li>• Check that the motor has sufficient cooling.</li> <li>• Check the set motor current and correct if necessary.</li> <li>• Contact customer service.</li> </ul>
E080.x	Control ECe-Booster: Frequency converter fault**	Frequency converter reports error	Read off the fault on the frequency converter and resolve in accordance with instructions.

#### Key:

\*"x" = represents the pump to which the fault shown applies!

\*\* Fault must be **manually** acknowledged.

#### 11.6 Further steps for troubleshooting

If the points listed here do not rectify the fault, please contact customer service. Costs may be incurred if other services are used. For more details, please contact customer service.

## 12 Disposal

#### 12.1 Information on the collection of used electrical and electronic products

Proper disposal and appropriate recycling of this product prevents damage to the environment and danger to your personal health.



## NOTICE

### Disposal in domestic waste is prohibited!

In the European Union this symbol may be included on the product, the packaging or the accompanying documentation. It means that the electrical and electronic products in question must not be disposed of along with domestic waste.

To ensure proper handling, recycling and disposal of the used products in question, please note the following points:

- Hand over these products at designated, certified collection points only.
- Observe the locally applicable regulations!

Please consult your local municipality, the nearest waste disposal site, or the dealer who sold the product to you for information on proper disposal. See [www.wilo-recycling.com](http://www.wilo-recycling.com) for more information about recycling.

## 13 Appendix

### 13.1 System impedances



## NOTICE

### Maximum switching frequency per hour

The connected motor determines the maximum switching frequency per hour.

- Note the technical data of the connected motor.
- Do not exceed the maximum switching frequency of the motor.



## NOTICE

- Depending on the system impedance and the maximum connections/hour of the connected consumers, voltage fluctuations and/or drops may occur.
- When using shielded cables, attach the shielding to the earth rail on one side of the control device.
- Always have connection carried out by a qualified electrician.
- Observe the installation and operating instructions for the connected pumps and signal transmitters.

3~400 V, 2-pole, direct starting		
Power in kW	System impedance in ohms	Connections/h
0.37	2.629	6 ... 30
0.55	1.573	6 ... 30
0.75	0.950	6 ... 18
0.75	0.944	24
0.75	0.850	30
1.1	0.628	6 ... 12
1.1	0.582	18
1.1	0.508	24
1.1	0.458	30
1.5	0.515	6 ... 12
1.5	0.431	18
1.5	0.377	24
1.5	0.339	30
2.2	0.321	6

3~400 V, 2-pole, direct starting		
Power in kW	System impedance in ohms	Connections/h
2.2	0.257	12
2.2	0.212	18
2.2	0.186	24
2.2	0.167	30
3.0	0.204	6
3.0	0.148	12
3.0	0.122	18
3.0	0.107	24
4.0	0.130	6
4.0	0.094	12
4.0	0.077	18
5.5	0.115	6
5.5	0.083	12
5.5	0.069	18

13.2 Overview of the symbols



Standby:  
 Symbol lights up: The switchgear is switched on and ready for operation.  
 Symbol flashing: Follow-up time of pump 1 active



Control mode: Constant pressure control (p-c)



Value input not possible:  
 1. Input disabled  
 2. The accessed menu only displays values.



Low water monitoring (dry-running protection) active



Pumps ready for operation/deactivated:  
 Symbol lights up: Pump is available and ready for operation.  
 Symbol flashing: Pump is deactivated.



“Extern OFF” input active: All pumps switched off



Pumps working/fault:  
 Symbol lights up: Pump is in operation.  
 Symbol flashing: Pump fault



There is at least one current (unacknowledged) error message.



A pump has been set as the standby pump.



The device communicates using a field bus system.

13.3 Overview of terminal diagrams

Wilo-Control EC-B2... terminal diagrams

1	2	3	4	5	6	7	8	9	10	11	12	13	14	15	16	17	18	19	20	21	22	23	24	25	26	27	28	29	30		
31	32	33	34	35	36	37	38	39	40	41	42	43	44	45	46	47	48	49	50	51	52	53	54								

Terminal	Function	Terminal	Function
2/3	Output: Individual run signal pump 1	16/17/18	Output: Collective fault signal
4/5	Output: Individual fault signal pump 1	21/22	Input: Extern OFF
6/7	Output: Low water level (dry-running protection) alarm	25/26	Input: Low water level (dry-running protection)
8/9	Output: Individual fault signal pump 2	37/38	Input: Pump 1 thermal winding monitor
10/11	Output: Individual run signal pump 2	39/40	Input: Pump 2 thermal winding monitor

Terminal	Function	Terminal	Function
13/14/15	Output: Collective run signal	45/46	Input: passive pressure sensor 4 – 20 mA

#### Wilco-Control EC-B3... terminal diagrams

1	2	3	4	5	6	7	8	9	10	11	12	13	14	15	16	17	18	19	20	21	22	23	24	25	26	27	28	29	30		
31	32	33	34	35	36	37	38	39	40	41	42	43	44	45	46	47	48	49	50	51	52	53	54	55	56	57	58	59	60		

Terminal	Function	Terminal	Function
3/4	Output: Individual run signal pump 1	20/21/22	Output: Collective fault signal
5/6	Output: Individual run signal pump 2	23/24	Input: Pump 1 thermal winding monitor
7/8	Output: Individual run signal pump 3	25/26	Input: Pump 2 thermal winding monitor
9/10	Output: Low water level (dry-running protection) alarm	27/28	Input: Pump 3 thermal winding monitor
11/12	Output: Individual fault signal pump 1	29/30	Input: Extern OFF
13/14	Output: Individual fault signal pump 2	31/32	Input: Low water level (dry-running protection)
15/16	Output: Individual fault signal pump 3	41/42	Input: passive pressure sensor 4 – 20 mA
17/18/19	Output: Collective run signal		

#### Wilco-Control ECe-B2... terminal diagrams

1	2	3	4	5	6	7	8	9	10	11	12	13	14	15	16	17	18	19	20	21	22	23	24	25	26	27	28	29	30		
31	32	33	34	35	36	37	38	39	40	41	42	43	44	45	46	47	48	49	50	51	52	53	54								

Terminal	Function	Terminal	Function
2/3	Output: Individual run signal pump 1	21/22	Input: Extern OFF
4/5	Output: Individual fault signal pump 1	25/26	Input: Low water level (dry-running protection)
6/7	Output: Low water level (dry-running protection) alarm	37/38	Input: Pump 1 frequency converter error message
8/9	Output: Individual fault signal pump 2	39/40	Input: Pump 2 frequency converter error message
10/11	Output: Individual run signal pump 2	41/42	Output: Pump 1 pressure setpoint
13/14/15	Output: Collective run signal	43/44	Output: Pump 2 pressure setpoint
16/17/18	Output: Collective fault signal	45/46	Input: passive pressure sensor 4 – 20 mA

Wilo-Control ECe-B3... terminal diagrams

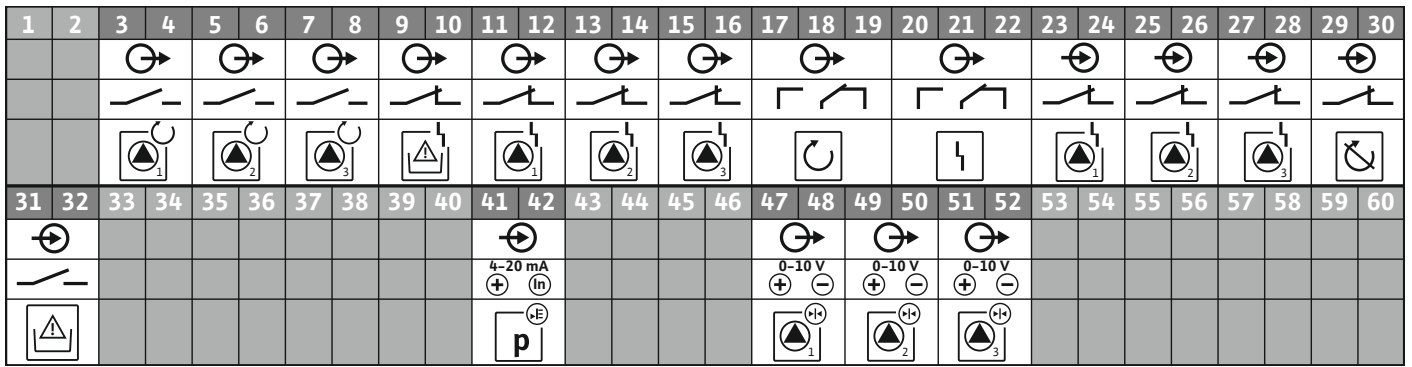

Terminal	Function	Terminal	Function
3/4	Output: Individual run signal pump 1	23/24	Input: Pump 1 frequency converter error message
5/6	Output: Individual run signal pump 2	25/26	Input: Pump 2 frequency converter error message
7/8	Output: Individual run signal pump 3	27/28	Input: Pump 3 frequency converter error message
9/10	Output: Low water level (dry-running protection) alarm	29/30	Input: Extern OFF
11/12	Output: Individual fault signal pump 1	31/32	Input: Low water level (dry-running protection)
13/14	Output: Individual fault signal pump 2	41/42	Input: passive pressure sensor 4 – 20 mA
15/16	Output: Individual fault signal pump 3	47/48	Output: Pump 1 pressure setpoint
17/18/19	Output: Collective run signal	49/50	Output: Pump 2 pressure setpoint
20/21/22	Output: Collective fault signal	51/52	Output: Pump 3 pressure setpoint

13.4 ModBus: Data types

Data type	Description
INT16	Integer in the range from -32768 to 32767. The number range actually used for a data point may vary.
UINT16	Unsigned integers in the range from 0 to 65535. The number range actually used for a data point may vary.
ENUM	Is a list. Only one of the values listed in the parameters can be set.
BOOL	A Boolean value is a parameter with exactly two states (0 – false and 1 – true). Generally, all values greater than zero are classified as true.
BITMAP*	Is an array of 16 Boolean values (bits). Values are indexed from 0 to 15. The number read from or written to the register is the sum of all bits with the value 1 multiplied by 2 to the power of its index. <ul style="list-style-type: none"> <li>• Bit 0: <math>2^0 = 1</math></li> <li>• Bit 1: <math>2^1 = 2</math></li> <li>• Bit 2: <math>2^2 = 4</math></li> <li>• Bit 3: <math>2^3 = 8</math></li> <li>• Bit 4: <math>2^4 = 16</math></li> <li>• Bit 5: <math>2^5 = 32</math></li> <li>• Bit 6: <math>2^6 = 64</math></li> <li>• Bit 7: <math>2^7 = 128</math></li> <li>• Bit 8: <math>2^8 = 256</math></li> <li>• Bit 9: <math>2^9 = 512</math></li> <li>• Bit 10: <math>2^{10} = 1024</math></li> <li>• Bit 11: <math>2^{11} = 2048</math></li> <li>• Bit 12: <math>2^{12} = 4096</math></li> <li>• Bit 13: <math>2^{13} = 8192</math></li> <li>• Bit 14: <math>2^{14} = 16384</math></li> <li>• Bit 15: <math>2^{15} = 32768</math></li> </ul>
BITMAP32	Is an array of 32 Boolean values (bits). Please check Bitmap for the calculation details.

\* Example for clarification:

Bit 3, 6, 8, and 15 are 1. All others are 0. The sum is then  $2^3+2^6+2^8+2^{15} = 8+64+256+32768 = 33096$ . It is also possible to do the calculation the other way round. Based on the bit with the highest index, check whether the read number is greater than/equal to the power of



two. If this is the case, bit 1 is set and the power of two is deducted from the number. Then the check with the bit with the next lower index and the recently calculated residual number is repeated until bit 0 is obtained or the residual number is zero. Example for clarification: The read number is 1416. Bit 15 will be 0, since  $1416 < 32768$ . Bits 14 to 11 will also be 0. Bit 10 will be 1, since  $1416 > 1024$ . The remainder will be  $1416 - 1024 = 392$ . Bit 9 will be 0, since  $392 < 512$ . Bit 8 will be 1, since  $392 > 256$ . The remainder will be  $392 - 256 = 136$ . Bit 7 will be 1, since  $136 > 128$ . The remainder will be  $136 - 128 = 8$ . Bits 6 to 4 will be 0. Bit 3 will be 1, since  $8 = 8$ . The remainder will be 0. The remaining bits 2 to 0 will thus all be 0.

### 13.5 ModBus: Parameter overview

Holding register (Protocol)	Name	Data type	Scale & unit	Elements	Access*	Added
40001 (0)	Version communication profile	UINT16	0.001		R	31.000
40002 (1)	Wink service	BOOL			RW	31.000
40003 (2)	Switch box type	ENUM		0. SC 1. SC...FC 2. SCe 3. CC 4. CC...FC 5. CCe 6. SCe NWB 7. CCe NWB 8. EC 9. ECe 10. ECe NWB	R	31.000
40014 (13)	Bus command timer	ENUM		0. – 1. Off 2. Set 3. Active 4. Reset 5. Manual	RW	31.000
40015 (14)	Drives on/off	BOOL			RW	31.000
40025 (24)	Control mode	ENUM		0. p-c 1. dp-c 2. dp-v 3. dT-c 4. dT-v 5. n(TV) 6. n(TR) 7. n(TP) 8. n(TA) 9. n-c 10. fill 11. empty/drain 12. FTS 13. cleans/day 14. cleans/month	R	31.000
40026 (25)	Current value	INT16	0.1 bar 0.1 m 0.1 K 0.1 °C 1 cm 1 min 0.1 h 0.1 psi		R	31.000

Holding register (Protocol)	Name	Data type	Scale & unit	Elements	Access*	Added
40041 (40)	Pump 1 mode	ENUM		0. Off 1. Hand 2. Auto	RW	31.000
40042 (41)	Pump 2 mode	ENUM		0. Off 1. Hand 2. Auto	RW	31.000
40043 (42)	Pump 3 mode	ENUM		0. Off 1. Hand 2. Auto	RW	31.000
40062 (61)	Switch box state	BITMAP		0: SBM 1: SSM	R	31.000
40139 - 40140 (138-139)	Error state	BITMAP32		0: Sensor error 1: P max 2: P min 3: FC 4: TLS 5: Pump 1 Alarm 6: Pump 2 Alarm 7: Pump 3 Alarm 8: Pump 4 Alarm 9: Pump 5 Alarm 10: Pump 6 Alarm 11: - 12: - 13: Frost 14: Battery Low 15: High water 16: Priority off 17: Redundancy 18: Plausibility 19: Slave communication 20: Net supply 21: Leakage	R	31.000
40141 (140)	Acknowledge	BOOL			W	31.000
40142 (141)	Alarm history index	UINT16			RW	31.000
40143 (142)	Alarm history error code	UINT16	0.1		R	31.000

**Key**

\* R = read-only, RW = read- and write-accessible



# wilo



Local contact at  
[www.wilo.com/contact](http://www.wilo.com/contact)

Pioneering for You

WILO SE  
Wilopark 1  
44263 Dortmund  
Germany  
T +49 (0)231 4102-0  
T +49 (0)231 4102-7363  
[wilo@wilo.com](mailto:wilo@wilo.com)  
[www.wilo.com](http://www.wilo.com)