

Data Sheet | Item Number: 2002-1311/1000-411

Component terminal block; 3-conductor; with diode 1N4007; anode, right side; for DIN-rail 35 x 15 and 35 x 7.5; 2.5 mm²; Push-in CAGE CLAMP®; gray

<https://www.wago.com/2002-1311/1000-411>

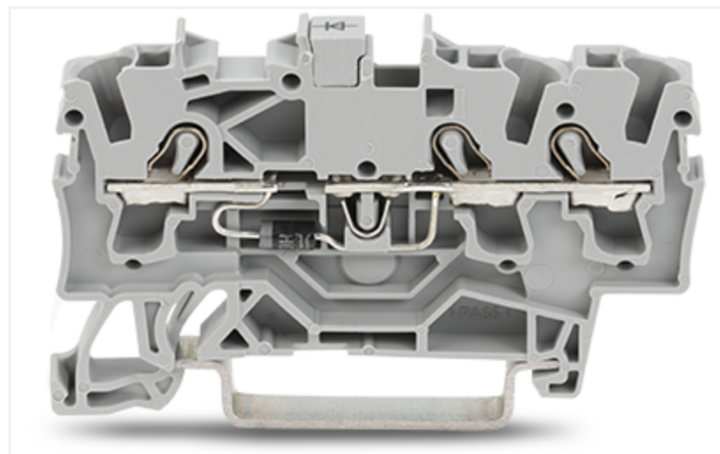
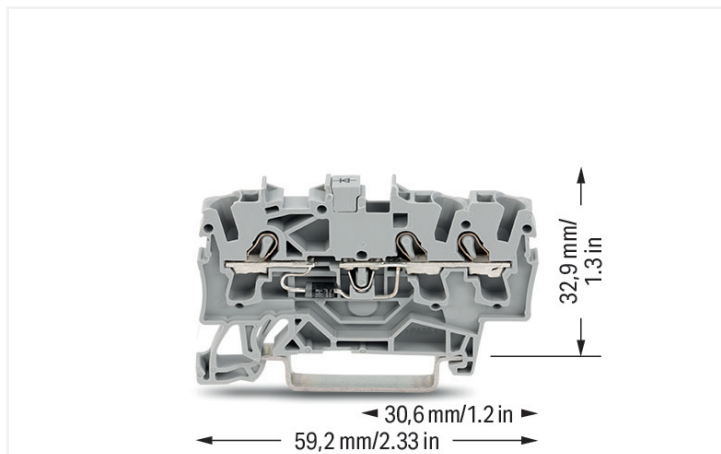

Color: ■ gray

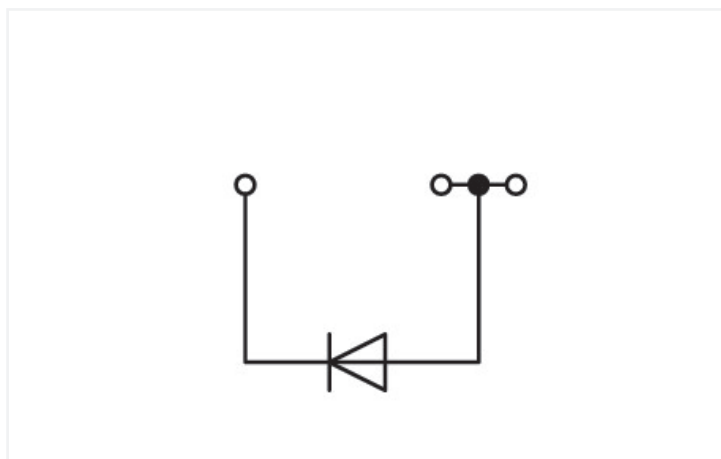

Component terminal block with diode, 2002 Series, operating tool

This component terminal block with diode (item number 2002-1311/1000-411) is designed for simple and secure connections. Conductors should only be connected to this component terminal block with diode if their strip length is between 10 and 12 mm. This product features conductor terminals and utilizes Push-in CAGE CLAMP®. Push-in CAGE CLAMP® connection technology is ideal for connecting all conductor types. It allows direct insertion of both solid and fine-stranded conductors with ferrules without needing to use any tools—all thanks to its pluggable design. This component terminal block with diode is suitable for conductor cross sections ranging from 0.25 mm² to 4 mm².

Electrical data

General information

Nominal voltage	250 V
Reverse voltage	1000 V
Continuous current (max.)	500 mA
Number/type of diode/LED	with 1N4007 diode
Wiring direction	Front-entry wiring

Connection Data

Clamping units	3
Total number of potentials	1
Number of levels	1
Number of jumper slots	1

Connection 1

Connection technology	Push-in CAGE CLAMP®
Actuation type	Operating tool
Connectable conductor materials	Copper
Nominal cross-section	2.5 mm ²
Solid conductor	0.25 ... 4 mm ² / 22 ... 12 AWG
Solid conductor; push-in termination	0.75 ... 4 mm ² / 18 ... 12 AWG
Fine-stranded conductor	0.25 ... 4 mm ² / 22 ... 12 AWG
Fine-stranded conductor; with insulated ferrule	0.25 ... 2.5 mm ² / 22 ... 14 AWG
Fine-stranded conductor; with ferrule; push-in termination	1 ... 2.5 mm ² / 18 ... 14 AWG
Note (conductor cross-section)	Depending on the conductor characteristic, a conductor with a smaller cross-section can also be inserted via push-in termination.
Strip length	10 ... 12 mm / 0.39 ... 0.47 inches
Wiring direction	Front-entry wiring

Physical data

Width	5.2 mm / 0.205 inches
Height	59.2 mm / 2.33 inches
Depth from upper-edge of DIN-rail	32.9 mm / 1.295 inches

Mechanical data

Mounting type	DIN-35 rail
Marking level	Center/side marking

Material data

Note (material data)	Information on material specifications can be found here
Color	gray
Material group	I
Insulation material (main housing)	Polyamide (PA66)
Flammability class per UL94	V0
Fire load	0.15 MJ
Weight	6.6 g

Environmental requirements

Processing temperature	-35 ... +85 °C
Continuous operating temperature	-60 ... +105 °C

Environmental Testing

Test specification: Railway applications – Rolling stock – Electronic equipment	DIN EN 50155 (VDE 0115-200):2022-06
Test procedure: Railway applications – Rolling stock equipment – Vibration and shock tests	DIN EN 61373 (VDE 0115-0106):2011-04
Spectrum/Mounting location	Service life test, Category 1, Class A/B
Functional test with noise-like oscillations	Test passed according to Section 8 of the standard
Frequency	f ₁ = 5 Hz to f ₂ = 150 Hz
Acceleration	0.101g (highest test level used for all axes)
Test duration per axis	10 min.

Environmental Testing

Test directions	X, Y and Z axes
Monitoring of contact faults and interruptions	Passed
Voltage drop measurement before and after each axis	Passed
Simulated service life test through increased levels of noise-like oscillations	Test passed according to Section 9 of the standard
Frequency	$f_1 = 5 \text{ Hz}$ to $f_2 = 150 \text{ Hz}$
Acceleration	0.572g (highest test level used for all axes)
Test duration per axis	5 h
Test directions	X, Y and Z axes
Extended testing: Monitoring of contact faults and interruptions	Passed
Extended testing: Voltage drop measurement before and after each axis	Passed
Shock test	Test passed according to Section 10 of the standard
Shock pulse form	Half sine
Acceleration	5g (highest test level used for all axes)
Shock duration	30 ms
Number of shocks (per axis)	3 pos. und 3 neg.
Test directions	X, Y and Z axes
Extended testing: Monitoring of contact faults and interruptions	Passed
Extended testing: Voltage drop measurement before and after each axis	Passed
Vibration and shock stress for rolling stock equipment	Passed

Commercial data

Product Group	22 (TOPJOB S)
PU (SPU)	100 pcs
Packaging type	Box
Country of origin	CN
GTIN	4045454537678
Customs tariff number	85369010000

Product Classification

UNSPSC	39121410
eCl@ss 10.0	27-14-11-27
eCl@ss 9.0	27-14-11-27
ETIM 9.0	EC000903
ETIM 10.0	EC000903
ECCN	NO US CLASSIFICATION

Environmental Product Compliance

CAS-No.	7439-92-1 79-94-7
REACH Candidate List Substance	2,2',6,6'-tetrabromo-4,4'-isopropylidenediphenol Lead
RoHS Compliance Status	Compliant,With Exemption
RoHS Exemption	7(a)
SCIP notification number (Austria)	a4e8cd97-68b7-45a5-a79c-a70f889629fd
SCIP notification number (Belgium)	e8cec2e9-bcf6-4414-8d6b-57fcc927fdf1
SCIP notification number (Bulgaria)	5f1726c7-6547-49dc-adf4-59d1c7528161
SCIP notification number (Czech Republic)	ac2ec238-e827-40be-8338-071132ad2970
SCIP notification number (Denmark)	75be4627-2258-4cbb-b9af-4cf959ac7a34
SCIP notification number (Finland)	eea39c61-dc21-443a-9986-70e8b2f05cc3
SCIP notification number (France)	c8f10ef0-0026-4dfb-b1d6-727c76df0f59
SCIP notification number (Germany)	9b0b7301-1a5c-4331-a5b2-9ba42b6e282d
SCIP notification number (Hungary)	076ed7bd-5d60-4d34-abb3-d6efe213c7bc
SCIP notification number (Italy)	5f4d3222-1463-4088-8370-327f8000a0f6
SCIP notification number (Netherlands)	358a5923-10c8-42e6-b0f7-c370c1260b57
SCIP notification number (Poland)	5b3e8b61-783d-45e8-89b7-0adf601954ff
SCIP notification number (Romania)	cd9e2dfb-d5a6-47f8-bf9b-abb2bb968296
SCIP notification number (Sweden)	52e63a7d-47bd-47c6-9029-9e328d356ad7

Approvals / Certificates

Declarations of conformity and manufacturer's declarations



Approval	Standard	Certificate Name
EU-Declaration of Confor- mity WAGO GmbH & Co. KG	-	-
Railway WAGO GmbH & Co. KG	-	Railway Ready
UK-Declaration of Confor- mity WAGO GmbH & Co. KG	-	-

Downloads

Environmental Product Compliance

Compliance Search
Environmental Product Compliance 2002-1311/1000-411

Documentation

Bid Text			
2002-1311/1000-411	29.04.2019	xml 3.91 KB	
2002-1311/1000-411	23.04.2019	docx 15.12 KB	

CAD/CAE-Data

CAD data	
2D/3D Models 2002-1311/1000-411	

CAE data	
EPLAN Data Portal 2002-1311/1000-411	
WSCAD Universe 2002-1311/1000-411	
ZUKEN Portal 2002-1311/1000-411	

1 Compatible Products

1.1 Required Accessories

1.1.1 End plate

1.1.1.1 End plate



Item No.: 2002-1391
End and intermediate plate; 0.8 mm thick; gray

Item No.: 2002-1392
End and intermediate plate; 0.8 mm thick; orange

1.2 Optional Accessories

1.2.1 DIN-rail

1.2.1.1 Mounting accessories



Item No.: 210-196
Aluminum carrier rail; 35 x 8.2 mm; 1.6 mm thick; 2 m long; unslotted; similar to EN 60715; silver-colored



Item No.: 210-198
Copper carrier rail; 35 x 15 mm; 2.3 mm thick; 2 m long; unslotted; according to EN 60715; copper-colored



Item No.: 210-508
Steel carrier rail; 35 x 15 mm; 1.5 mm thick; 2 m long; slotted; galvanized; similar to EN 60715; silver-colored



Item No.: 210-197
Steel carrier rail; 35 x 15 mm; 1.5 mm thick; 2 m long; slotted; similar to EN 60715; silver-colored



Item No.: 210-506
Steel carrier rail; 35 x 15 mm; 1.5 mm thick; 2 m long; unslotted; galvanized; similar to EN 60715; silver-colored



Item No.: 210-114
Steel carrier rail; 35 x 15 mm; 1.5 mm thick; 2 m long; unslotted; similar to EN 60715; silver-colored



Item No.: 210-118
Steel carrier rail; 35 x 15 mm; 2.3 mm thick; 2 m long; unslotted; according to EN 60715; silver-colored



Item No.: 210-115
Steel carrier rail; 35 x 7.5 mm; 1 mm thick; 2 m long; slotted; according to EN 60715; "Hole width 18 mm; silver-colored



Item No.: 210-112
Steel carrier rail; 35 x 7.5 mm; 1 mm thick; 2 m long; slotted; according to EN 60715; "Hole width 25 mm; silver-colored



Item No.: 210-504
Steel carrier rail; 35 x 7.5 mm; 1 mm thick; 2 m long; slotted; galvanized; according to EN 60715; silver-colored



Item No.: 210-113
Steel carrier rail; 35 x 7.5 mm; 1 mm thick; 2 m long; unslotted; according to EN 60715; silver-colored



Item No.: 210-505
Steel carrier rail; 35 x 7.5 mm; 1 mm thick; 2 m long; unslotted; galvanized; according to EN 60715; silver-colored

1.2.2 End plate

1.2.2.1 End plate



Item No.: 2002-1393

Separator plate; 2 mm thick; oversized; gray

Item No.: 2002-1394

Separator plate; 2 mm thick; oversized; orange

1.2.3 Ferrule

1.2.3.1 Ferrule



Item No.: 216-241

Ferrule; Sleeve for 0.5 mm² / 20 AWG; insulated; electro-tin plated; electrolytic copper; gastight crimped; acc. to DIN 46228, Part 4/09.90; white



Item No.: 216-242

Ferrule; Sleeve for 0.75 mm² / 18 AWG; insulated; electro-tin plated; electrolytic copper; gastight crimped; acc. to DIN 46228, Part 4/09.90; gray



Item No.: 216-262

Ferrule; Sleeve for 0.75 mm² / 18 AWG; insulated; electro-tin plated; electrolytic copper; gastight crimped; acc. to DIN 46228, Part 4/09.90; gray



Item No.: 216-243

Ferrule; Sleeve for 1 mm² / AWG 18; insulated; electro-tin plated; electrolytic copper; gastight crimped; acc. to DIN 46228, Part 4/09.90; red



Item No.: 216-263

Ferrule; Sleeve for 1 mm² / AWG 18; insulated; electro-tin plated; electrolytic copper; gastight crimped; acc. to DIN 46228, Part 4/09.90; red



Item No.: 216-244

Ferrule; Sleeve for 1.5 mm² / AWG 16; insulated; electro-tin plated; electrolytic copper; gastight crimped; acc. to DIN 46228, Part 4/09.90; black



Item No.: 216-264

Ferrule; Sleeve for 1.5 mm² / AWG 16; insulated; electro-tin plated; electrolytic copper; gastight crimped; acc. to DIN 46228, Part 4/09.90; black



Item No.: 216-246

Ferrule; Sleeve for 2.5 mm² / AWG 14; insulated; electro-tin plated; electrolytic copper; gastight crimped; acc. to DIN 46228, Part 4/09.90; blue



Item No.: 216-266

Ferrule; Sleeve for 2.5 mm² / AWG 14; insulated; electro-tin plated; electrolytic copper; gastight crimped; acc. to DIN 46228, Part 4/09.90; blue

1.2.4 Installation

1.2.4.1 Cover



Item No.: 709-156

Cover; Type 3; suitable for cover carrier, type 3; 1 m long; transparent

1.2.4.2 Cover carrier



Item No.: 709-169

Cover carrier; Type 3; incl. fixing/retaining screws and knurled nut; suitable for 279 to 282 and 880 Series rail-mounted terminal blocks; suitable for 264 Series miniature rail-mounted terminal blocks; suitable for 270 Series sensor and actuator terminal blocks; gray

1.2.5 Insulation stop

1.2.5.1 Insulation stop



Item No.: 2002-171

Insulation stop; 0.25 - 0.5 mm²; 5 pieces/strip; light gray

Item No.: 2002-172

Insulation stop; 0.75 - 1 mm²; 5 pieces/strip; dark gray

1.2.6 Jumper

1.2.6.1 Jumper



Item No.: 2002-400

Continuous jumper; 2-way; insulated; light gray



Item No.: 2002-413

Continuous jumper; 3-way; insulated; light gray



Item No.: 2002-415

Continuous jumper; 5-way; insulated; light gray



Item No.: 2002-423/000-006

Continuous jumper; from 1 to 3; insulated; blue



Item No.: 2002-423

Continuous jumper; from 1 to 3; insulated; light gray



Item No.: 2002-423/000-005

Continuous jumper; from 1 to 3; insulated; red



Item No.: 2002-424/000-006

Continuous jumper; from 1 to 4; insulated; blue



Item No.: 2002-424

Continuous jumper; from 1 to 4; insulated; light gray



Item No.: 2002-424/000-005

Continuous jumper; from 1 to 4; insulated; red



Item No.: 2002-406/020-000

Delta jumper; insulated; light gray



Item No.: 2002-410/000-006

Jumper; 10-way; insulated; blue



Item No.: 2002-410

Jumper; 10-way; insulated; light gray



Item No.: 2002-410/000-005

Jumper; 10-way; insulated; red



Item No.: 2002-402/000-006

Jumper; 2-way; insulated; blue



Item No.: 2002-402

Jumper; 2-way; insulated; light gray



Item No.: 2002-402/000-005

Jumper; 2-way; insulated; red



Item No.: 2002-403/000-006

Jumper; 3-way; insulated; blue



Item No.: 2002-403

Jumper; 3-way; insulated; light gray



Item No.: 2002-403/000-005

Jumper; 3-way; insulated; red



Item No.: 2002-404/000-006

Jumper; 4-way; insulated; blue



Item No.: 2002-404

Jumper; 4-way; insulated; light gray



Item No.: 2002-404/000-005

Jumper; 4-way; insulated; red



Item No.: 2002-405/000-006

Jumper; 5-way; insulated; blue



Item No.: 2002-405

Jumper; 5-way; insulated; light gray



Item No.: 2002-405/000-005

Jumper; 5-way; insulated; red



Item No.: 2002-406/000-006

Jumper; 6-way; insulated; blue



Item No.: 2002-406

Jumper; 6-way; insulated; light gray



Item No.: 2002-406/000-005

Jumper; 6-way; insulated; red



Item No.: 2002-407/000-006

Jumper; 7-way; insulated; blue



Item No.: 2002-407

Jumper; 7-way; insulated; light gray



Item No.: 2002-407/000-005

Jumper; 7-way; insulated; red



Item No.: 2002-408/000-006

Jumper; 8-way; insulated; blue



Item No.: 2002-408

Jumper; 8-way; insulated; light gray



Item No.: 2002-408/000-005

Jumper; 8-way; insulated; red



Item No.: 2002-409/000-006

Jumper; 9-way; insulated; blue



Item No.: 2002-409

Jumper; 9-way; insulated; light gray



Item No.: 2002-409/000-005

Jumper; 9-way; insulated; red



Item No.: 2002-440

Jumper; from 1 to 10; insulated; light gray



Item No.: 2002-433

Jumper; from 1 to 3; insulated; light gray



Item No.: 2002-434

Jumper; from 1 to 4; insulated; light gray



Item No.: 2002-435

Jumper; from 1 to 5; insulated; light gray



Item No.: 2002-436

Jumper; from 1 to 6; insulated; light gray



Item No.: 2002-437















Jumper; from 1 to 7; insulated; light gray



Item No.: 2002-438



Jumper; from 1 to 8; insulated; light gray

1.2.6.1 Jumper

























 Item No.: 2002-439 Jumper; from 1 to 9; insulated; light gray	 Item No.: 2002-480 Staggered jumper; 10-way; insulated; light gray	 Item No.: 2002-481 Staggered jumper; 11-way; insulated; light gray	 Item No.: 2002-482 Staggered jumper; 12-way; insulated; light gray
 Item No.: 2002-472 Staggered jumper; 2-way; insulated; light gray	 Item No.: 2002-473 Staggered jumper; 3-way; insulated; light gray	 Item No.: 2002-474 Staggered jumper; 4-way; insulated; light gray	 Item No.: 2002-475 Staggered jumper; 5-way; insulated; light gray
 Item No.: 2002-476 Staggered jumper; 6-way; insulated; light gray	 Item No.: 2002-477 Staggered jumper; 7-way; insulated; light gray	 Item No.: 2002-478 Staggered jumper; 8-way; insulated; light gray	 Item No.: 2002-479 Staggered jumper; 9-way; insulated; light gray
 Item No.: 2002-405/011-000 Star point jumper; 3-way; insulated; light gray	 Item No.: 210-103 Wire commoning chain; insulated; black	 Item No.: 210-123 Wire commoning chain; insulated; blue	

1.2.7 Marking

1.2.7.1 Group marker carrier

 Item No.: 2009-191 Group marker carrier; gray	 Item No.: 2009-192 Group marker carrier; gray	 Item No.: 2009-193 Group marker carrier; gray
---	---	---

1.2.7.2 Marker

 Item No.: 2009-145/000-006 Mini-WSB Inline; for Smart Printer; 1700 pieces on roll; stretchable 5 - 5.2 mm; plain; snap-on type; blue	 Item No.: 2009-145/000-007 Mini-WSB Inline; for Smart Printer; 1700 pieces on roll; stretchable 5 - 5.2 mm; plain; snap-on type; gray	 Item No.: 2009-145/000-023 Mini-WSB Inline; for Smart Printer; 1700 pieces on roll; stretchable 5 - 5.2 mm; plain; snap-on type; green	 Item No.: 2009-145/000-012 Mini-WSB Inline; for Smart Printer; 1700 pieces on roll; stretchable 5 - 5.2 mm; plain; snap-on type; orange
 Item No.: 2009-145/000-005 Mini-WSB Inline; for Smart Printer; 1700 pieces on roll; stretchable 5 - 5.2 mm; plain; snap-on type; red	 Item No.: 2009-145/000-024 Mini-WSB Inline; for Smart Printer; 1700 pieces on roll; stretchable 5 - 5.2 mm; plain; snap-on type; violet	 Item No.: 2009-145 Mini-WSB Inline; for Smart Printer; 1700 pieces on roll; stretchable 5 - 5.2 mm; plain; snap-on type; white	 Item No.: 2009-145/000-002 Mini-WSB Inline; for Smart Printer; 1700 pieces on roll; stretchable 5 - 5.2 mm; plain; snap-on type; yellow
 Item No.: 248-501/000-006 Mini-WSB marking card; as card; not stretchable; plain; snap-on type; blue	 Item No.: 248-501/000-007 Mini-WSB marking card; as card; not stretchable; plain; snap-on type; gray	 Item No.: 248-501/000-023 Mini-WSB marking card; as card; not stretchable; plain; snap-on type; green	 Item No.: 248-501/000-017 Mini-WSB marking card; as card; not stretchable; plain; snap-on type; light green
 Item No.: 248-501/000-012 Mini-WSB marking card; as card; not stretchable; plain; snap-on type; orange	 Item No.: 248-501/000-005 Mini-WSB marking card; as card; not stretchable; plain; snap-on type; red	 Item No.: 248-501/000-024 Mini-WSB marking card; as card; not stretchable; plain; snap-on type; violet	 Item No.: 248-501 Mini-WSB marking card; as card; not stretchable; plain; snap-on type; white
 Item No.: 248-501/000-002 Mini-WSB marking card; as card; not stretchable; plain; snap-on type; yellow	 Item No.: 793-5501/000-006 WMB marking card; as card; for terminal block width 5 - 17.5 mm; stretchable 5 - 5.2 mm; plain; snap-on type; blue	 Item No.: 793-5501/000-014 WMB marking card; as card; for terminal block width 5 - 17.5 mm; stretchable 5 - 5.2 mm; plain; snap-on type; brown	 Item No.: 793-5501/000-007 WMB marking card; as card; for terminal block width 5 - 17.5 mm; stretchable 5 - 5.2 mm; plain; snap-on type; gray
 Item No.: 793-5501/000-023 WMB marking card; as card; for terminal block width 5 - 17.5 mm; stretchable 5 - 5.2 mm; plain; snap-on type; green	 Item No.: 793-5501/000-017 WMB marking card; as card; for terminal block width 5 - 17.5 mm; stretchable 5 - 5.2 mm; plain; snap-on type; light green	 Item No.: 793-5501/000-012 WMB marking card; as card; for terminal block width 5 - 17.5 mm; stretchable 5 - 5.2 mm; plain; snap-on type; orange	 Item No.: 793-5501/000-005 WMB marking card; as card; for terminal block width 5 - 17.5 mm; stretchable 5 - 5.2 mm; plain; snap-on type; red

1.2.7.2 Marker



Item No.: 793-5501/000-024
WMB marking card; as card; for terminal block width 5 - 17.5 mm; stretchable 5 - 5.2 mm; plain; snap-on type; violet

Item No.: 793-5501
WMB marking card; as card; for terminal block width 5 - 17.5 mm; stretchable 5 - 5.2 mm; plain; snap-on type; white

Item No.: 793-5501/000-002
WMB marking card; as card; for terminal block width 5 - 17.5 mm; stretchable 5 - 5.2 mm; plain; snap-on type; yellow

Item No.: 2009-115/000-006
WMB-Inline; for Smart Printer; 1500 pieces on roll; stretchable 5 - 5.2 mm; plain; snap-on type; blue



Item No.: 2009-115/000-007
WMB-Inline; for Smart Printer; 1500 pieces on roll; stretchable 5 - 5.2 mm; plain; snap-on type; gray

Item No.: 2009-115/000-023
WMB-Inline; for Smart Printer; 1500 pieces on roll; stretchable 5 - 5.2 mm; plain; snap-on type; green

Item No.: 2009-115/000-017
WMB-Inline; for Smart Printer; 1500 pieces on roll; stretchable 5 - 5.2 mm; plain; snap-on type; light green

Item No.: 2009-115/000-012
WMB-Inline; for Smart Printer; 1500 pieces on roll; stretchable 5 - 5.2 mm; plain; snap-on type; orange



Item No.: 2009-115/000-005
WMB-Inline; for Smart Printer; 1500 pieces on roll; stretchable 5 - 5.2 mm; plain; snap-on type; red

Item No.: 2009-115/000-024
WMB-Inline; for Smart Printer; 1500 pieces on roll; stretchable 5 - 5.2 mm; plain; snap-on type; violet

Item No.: 2009-115
WMB-Inline; for Smart Printer; 1500 pieces on roll; stretchable 5 - 5.2 mm; plain; snap-on type; white

Item No.: 2009-115/000-002
WMB-Inline; for Smart Printer; 1500 pieces on roll; stretchable 5 - 5.2 mm; plain; snap-on type; yellow

1.2.7.3 Marker carrier



Item No.: 2002-161
Adaptor; gray

Item No.: 2009-198
Adaptor; gray

1.2.7.4 Marking strip



Item No.: 2009-110
Marking strips; for Smart Printer; on reel; not stretchable; plain; snap-on type; white

1.2.8 Protective warning marker

1.2.8.1 Cover



Item No.: 2002-115
Protective warning marker; for 5 terminal blocks; with high-voltage symbol, black; yellow

1.2.9 Push-in type wire jumper

1.2.9.1 Jumper



Item No.: 2009-414
Push-in type wire jumper; 1.5 mm²; insulated; 110 mm long; black

Item No.: 2009-414/000-005
Push-in type wire jumper; 1.5 mm²; insulated; 110 mm long; black

Item No.: 2009-416
Push-in type wire jumper; 1.5 mm²; insulated; 250 mm long; black

Item No.: 2009-414/000-006
Push-in type wire jumper; insulated; 110 mm long; black



Item No.: 2009-412
Push-in type wire jumper; insulated; 60 mm long; black

1.2.10 Screwless end stop

1.2.10.1 Mounting accessories



Item No.: 249-117

Screwless end stop; 10 mm wide; for DIN-rail 35 x 15 and 35 x 7.5; gray



Item No.: 249-116

Screwless end stop; 6 mm wide; for DIN-rail 35 x 15 and 35 x 7.5; gray

1.2.11 Test and measurement

1.2.11.1 Testing accessories



Item No.: 2002-560

Modular TOPJOB®S connector; modular; for jumper contact slot; 10-pole; gray



Item No.: 2002-511

Modular TOPJOB®S connector; modular; for jumper contact slot; 1-pole; gray



Item No.: 2002-552

Modular TOPJOB®S connector; modular; for jumper contact slot; 2-pole; gray



Item No.: 2002-553

Modular TOPJOB®S connector; modular; for jumper contact slot; 3-pole; gray



Item No.: 2002-554

Modular TOPJOB®S connector; modular; for jumper contact slot; 4-pole; gray



Item No.: 2002-555

Modular TOPJOB®S connector; modular; for jumper contact slot; 5-pole; gray



Item No.: 2002-556

Modular TOPJOB®S connector; modular; for jumper contact slot; 6-pole; gray



Item No.: 2002-557

Modular TOPJOB®S connector; modular; for jumper contact slot; 7-pole; gray



Item No.: 2002-558

Modular TOPJOB®S connector; modular; for jumper contact slot; 8-pole; gray



Item No.: 2002-559

Modular TOPJOB®S connector; modular; for jumper contact slot; 9-pole; gray



Item No.: 2002-549

Spacer module; modular; e.g., for bridging commoned terminal blocks; gray



Item No.: 2009-174

Test plug adapter; for 4 mm Ø test plugs; for testing TOPJOB®S rail-mounted terminal blocks; gray



Item No.: 2009-182

Testing tap; for max. 2.5 mm²; tool-free connection for individual test wires 0.08 - 2.5 mm; gray



Item No.: 2002-649

TOPJOB®S L-type spacer module; modular; e.g., for bridging commoned terminal blocks; gray



Item No.: 2002-611

TOPJOB®S L-type test plug module; modular; 1-pole; gray

1.2.12 Tool

1.2.12.1 Operating tool



Item No.: 210-658

Operating tool; Blade: 3.5 x 0.5 mm; with a partially insulated shaft; angled; short; multicoloured



Item No.: 210-720

Operating tool; Blade: 3.5 x 0.5 mm; with a partially insulated shaft; multicoloured

Installation Notes

Conductor termination

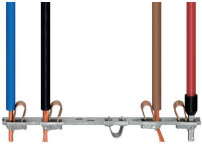

All conductor types at a glance

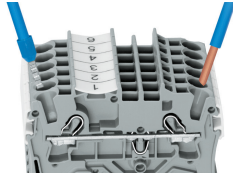

Push-in termination of solid and ferruled conductors

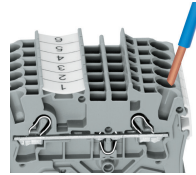

Inserting a conductor via push-in termination:
Solid conductors with cross-sections from either one size above, or up to two sizes below, the rated cross-section can be simply pushed in – no tools needed.

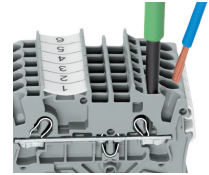

Inserting a conductor via operating tool:
Connecting fine-stranded conductors without ferrules, or small cross-sectional conductors that cannot be pushed in, is performed similarly to the original CAGE CLAMP® – just use an operating tool.
Advantage:
To open the clamp, the operating tool is inserted vertically. The conductor entry is less than 15 degrees for easier wiring.

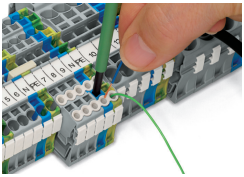

Conductor termination – insulation stop

Commoning

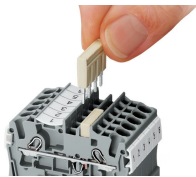

Insert push-in type jumper bar and push down until it hits backstop.

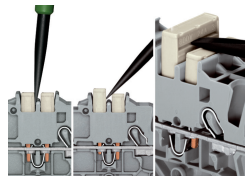

Removing a push-in type jumper bar:
Insert the operating tool between the jumper and partition wall of the dual jumper slots, then lift up the jumper. Place the operating tool in the center of jumpers for up to five contacts (see above), or alternately on both sides for jumpers with more than five contacts.

Commoning

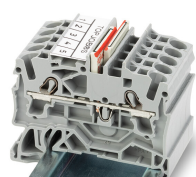

Orient the staggered jumpers' red stripes on the inside. Insert the staggered jumper and push down until it hits the backstop.

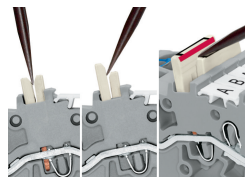

Removing a staggered jumper:
Insert the operating tool between the staggered jumpers, then lift up the jumper.

Commoning

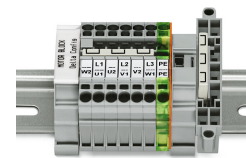
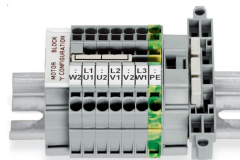
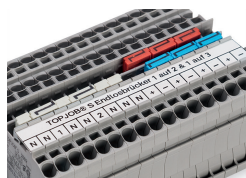
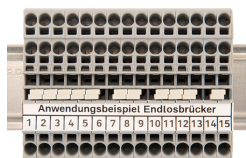

Continuous jumpers (2002 Series) readily connect an endless number of terminal blocks to each other via single jumper slot. Use the second jumper slot for additional commoning or testing.

The 1-to-3 adjacent jumper for continuous commoning enables every other terminal block to be commoned. For example, positive and negative potentials can be accommodated alongside each other.

This star point jumper has been specially developed to create a "star point" and is used on motor terminal boards equipped with Rail-Mount Terminal Blocks TOPJOB® S.

This delta jumper has been specially developed to create a delta configuration and is used on motor terminal boards equipped with rail-mount terminal blocks TOPJOB® S.

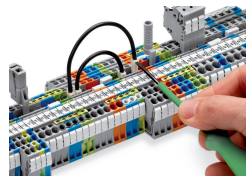

Push down the wire jumper until fully inserted. Lift the jumper with an operating tool for rewiring.

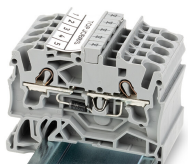

These diode terminal blocks have been specially developed for custom diode circuits, such as lamp test and collective fault signal circuits.

Testing

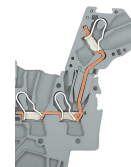
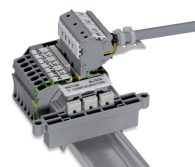
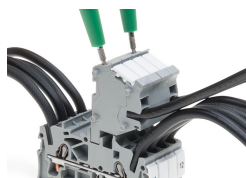
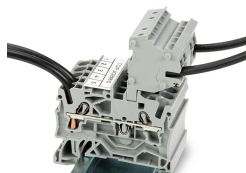

The modular TOPJOB® S connectors also connect conductors of the same size as the terminal blocks being used.

TOPJOB® S Connectors with a 2 mm Ø test socket for testing voltage via 2-pole voltage tester

Rail-mount terminal block assembly for electric motor wiring

L-type test plug module – cross-sectional view of contacts



Test plug adapter (2009-174, CAT I) for 4 mm Ø plugs – compatible with 2000 to 2016 Series

Testing tap (2009-182) for tool-free connection of test cables up to 2.5 mm² (12 AWG) – compatible with 2000 to 2016 Series

Marking

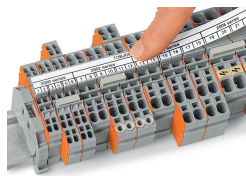
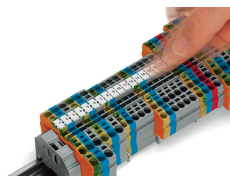

Snapping WMB Inline markers into marker slots.



Polarized diode gates with a common cathode can be created using the following terminal blocks:

- 2002-1311/1000-410 or
- 2002-1311/1000-411