

# Productinformatieblad

Specificaties



## Drukknop, Verzonken, Terugvering, Ø22mm, Zwart chroom

ZB4BA24

EAN Code: 3389110079104

**Prijs: 19,05 EUR**

### Hoofd

range of product	Harmony XB4
product or component type	Kop voor niet-verlichte drukknop
device short name	ZB4
kraag materiaal	Verchroomd metaal
bevestigingsdiameter	22,5 mm
verkoop per ondeelbare hoeveelheid	1
koptype	Standaard
vorm van kop signaleringseenheid	Rond
type operator	terugverend
operator profiel	Zwart verzonken, niet gemarkeerd
extra informatie operator	Hoge beveiliging
kap/operator of lenskleur	Zwart

### Complementair

CAD totale breedte	29 mm
CAD totale hoogte	29 mm
CAD totale diepte	31 mm
mechanical durability	10000000 cycles
elektrische samenstellingscode	C1 voor <9 contacten gebruik enkelvoudig blokken in vooraan gemonteerd C2 voor <9 contacten gebruik enkelvoudig en dubbel blokken in vooraan gemonteerd C11 voor <3 contacten gebruik enkelvoudig blokken in vooraan gemonteerd C15 voor <1 contacten gebruik enkelvoudig blokken in vooraan gemonteerd
product presentatie	Basisonderdeel

### Omgeving

beschermende behandeling	TH
ambient air temperature for storage	-40...70 °C
ambient air temperature for operation	-40...70 °C
overvoltage category	Klasse I In overeenstemming met IEC 60536
IP beschermingsgraad	IP66 In overeenstemming met IEC 60529 IP67 IP69 IP69K

De weergegeven prijs is de adviesprijs in euro excl. BTW. Deze kan onderhevig zijn aan korting. Neem contact op met uw lokale distributeur of detailhandel voor de daadwerkelijke prijs

<b>NEMA beschermingsgraad</b>	NEMA 13 NEMA 4X
<b>IK-beschermingsgraad</b>	IK06 In overeenstemming met IEC 50102
<b>standards</b>	UL 508 IEC 60947-5-4 JIS C8201-5-1 IEC 60947-5-5 IEC 60947-5-1 IEC 60947-1 CSA C22.2 Nr 14 JIS C8201-1
<b>product certifications</b>	BV CSA DNV LROS (Lloyds register of shipping) UL listed
<b>trilling bestendigheid</b>	5 gn (f= 2...500 Hz) In overeenstemming met IEC 60068-2-6
<b>schokbestendigheid</b>	30 gn (duur = 18 ms) voor halve sinusgolf versnelling In overeenstemming met IEC 60068-2-27 50 gn (duur = 11 ms) voor halve sinusgolf versnelling In overeenstemming met IEC 60068-2-27

## Verpakkingseenheid

<b>Eenheidstype_van_verpakking_1</b>	PCE
<b>Aantal_eenheden_in_verpakking_1</b>	1
<b>verpakking_1_hoogte</b>	3,500 cm
<b>verpakking_1_breedte</b>	4,600 cm
<b>verpakking_1_lengte</b>	5,300 cm
<b>verpakking_1_gewicht</b>	34,000 g
<b>Eenheidstype_van_verpakking_2</b>	S03
<b>Aantal_eenheden_in_verpakking_2</b>	200
<b>Package 2 Height</b>	30,000 cm
<b>Package 2 Width</b>	30,000 cm
<b>verpakking_2_lengte</b>	40,000 cm
<b>verpakking_2_gewicht</b>	7,513 kg

## contractuele waarborg

<b>Garantie</b>	18 months
-----------------	-----------

## Environmental Data

Schneider Electric wil tegen 2050 de Net Zero-status hebben bereikt via partnerschappen in de toeleveringsketen, materialen met een lagere impact en circulariteit via onze doorlopende campagne "Use Better, Use Longer, Use Again" om de levensduur van producten en de recycleerbaarheid te verlengen.

[Uitleg van Environmental Data](#) >

[Hoe evalueren we de duurzaamheid van producten?](#) >

### Milieuoetafdruk

Totale levenscyclus ecologische voetafdruk 1

Milieuprofiel van product (PEP) [Milieuprofiel van het product](#)

## Use Better

### Materialen en verpakking

Pakket met gerecycleerd karton Ja

Verpakkingen zonder kunststof Ja

[EU-richtlijn RoHS](#)

Voldoet pro-actief (Product valt niet onder de EU RoHS juridische scope)

## Use Again

### Herverpakken en herfabriceren

Circulair Profiel [Informatie over einde levensduur](#)

Terugname Ja

Dimensions Drawings

Dimensions

---

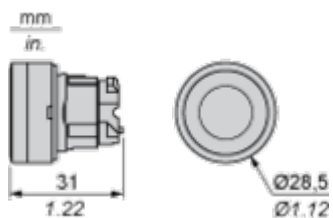

Mounting and Clearance

**Panel Cut-out for Pushbuttons, Switches and Pilot Lights (Finished Holes, Ready for Installation)**

Connection by Screw Clamp Terminals or Plug-in Connectors or on Printed Circuit Board	Connection by Faston Connectors
	
<p>(1) Diameter on finished panel or support                  (2) 40 mm min. / 1.57 in. min.                  (3) 30 mm min. / 1.18 in. min.                  (4) <math>\varnothing 22.5 \text{ mm} / 0.89 \text{ in.}</math> recommended (<math>\varnothing 22.3 \text{ mm} \begin{smallmatrix} +0.4 \\ 0 \end{smallmatrix} / 0.88 \text{ in.} \begin{smallmatrix} +0.016 \\ 0 \end{smallmatrix}</math>)                  (5) 45 mm min. / 1.78 in. min.                  (6) 32 mm min. / 1.26 in. min.</p>	

Pushbuttons, Switches and Pilot Lights for Printed Circuit Board Connection

Panel Cut-outs (Viewed from Installer's Side)



A: 30 mm min. / 1.18 in. min.

B: 40 mm min. / 1.57 in. min.

Printed Circuit Board Cut-outs (Viewed from Electrical Block Side)

Dimensions in mm

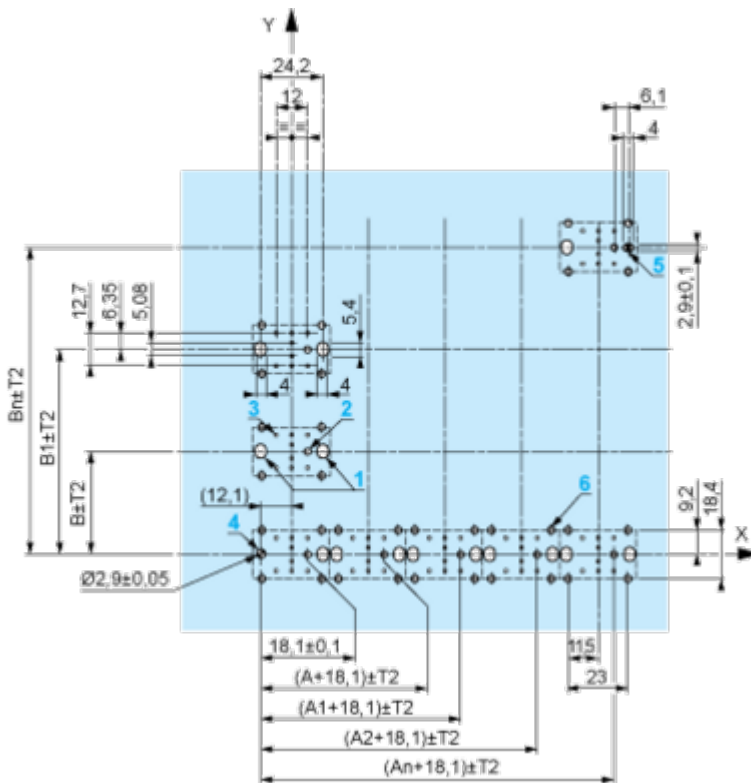

A: 30 mm min.

B: 40 mm min.

Dimensions in in.

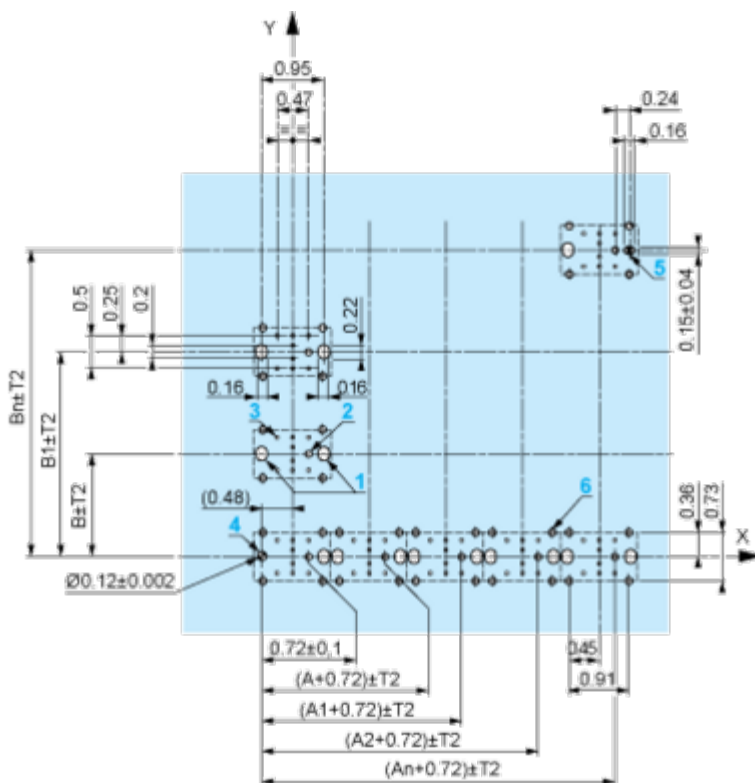

A: 1.18 in. min.

B: 1.57 in. min.

**General Tolerances of the Panel and Printed Circuit Board**

The cumulative tolerance must not exceed 0.3 mm / 0.012 in: T1 + T2 = 0.3 mm max.

**Installation Precautions**

- Minimum thickness of circuit board: 1.6 mm / 0.06 in.
- Cut-out diameter: 22.4 mm ± 0.1 / 0.88 in. ± 0.004
- Orientation of body/fixing collar ZB4 BZ009: ± 2° 30' (excluding cut-outs marked a and b).
- Tightening torque of screws ZBZ 006: 0.6 N.m (5.3 lbf.in) max.
- Allow for one ZB4 BZ079 fixing collar/pillar and its fixing screws:
  - every 90 mm / 3.54 in. horizontally (X), and 120 mm / 4.72 in. vertically (Y).
  - with each selector switch head (ZB4 BD\*, ZB4 BJ\*, ZB4 BG\*).

The fixing centers marked a and b are diagonally opposed and must align with those marked 4 and 5.

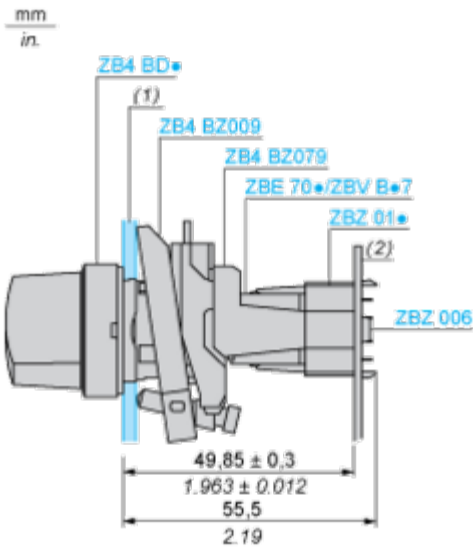

(1) Panel

(2) Printed circuit board

#### Mounting of Adapter (Socket) ZBZ 01•

- 1 2 elongated holes for ZBZ 006 screw access
- 2 1 hole  $\varnothing 2.4 \text{ mm} \pm 0.05 / 0.09 \text{ in.} \pm 0.002$  for centring adapter ZBZ 01•
- 3  $8 \times \varnothing 1.2 \text{ mm} / 0.05 \text{ in.}$  holes
- 4 1 hole  $\varnothing 2.9 \text{ mm} \pm 0.05 / 0.11 \text{ in.} \pm 0.002$ , for aligning the printed circuit board (with cut-out marked a)
- 5 1 elongated hole for aligning the printed circuit board (with cut-out marked b)
- 6 4 holes  $\varnothing 2.4 \text{ mm} / 0.09 \text{ in.}$  for clipping in adapter ZBZ 01•

Dimensions An + 18.1 relate to the  $\varnothing 2.4 \text{ mm} \pm 0.05 / 0.09 \text{ in.} \pm 0.002$  holes for centring adapter ZBZ 01•.

Technical Description

Electrical Composition Corresponding to Code C1

---



Electrical Composition Corresponding to Code C2

---

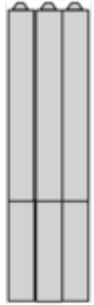

Electrical Composition Corresponding to Codes C9, C11, SF1 and SR1



Electrical Composition Corresponding to Code C15

---

1 N/O



1 N/C



1 N/O + N/C or 1 N/O + N/O or 1 N/C + N/C



**Legend**

---

Single contact



Double contact



Light block



Possible location



Technical Illustration

Dimensions

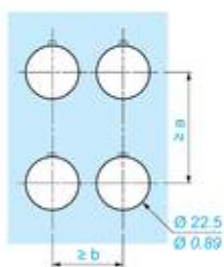
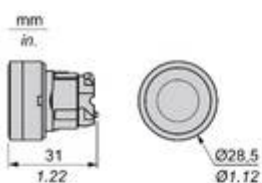

	a (mm)	a (in.)	b (mm)	b (in.)
	40	1.57	30	1.18
ZBE..... ZBV.....				
	45	1.77	32	1.26
ZBE.....3 ZBV.....3				
	40	1.57	30	1.18
ZBE.....4 ZBV.....4				
	50	1.97	30	1.18
ZBE.....5 ZBV.....5				
	40	1.57	30	1.18
ZBE.....9 ZBV.....9				
	40	1.57	30	1.18
ZBRT... ZBRV1				